

# Dental Instruments Catalogue



# SAR SONS

Manufacturers & Exporters of Dental Instruments

## Dear Valued Buyers

We feel immense pleasure to present our latest catalogue in which we have featured a most comprehensive range of all types of quality Surgical & Dental instruments required for day to day use for Hospital. We will be pleased to quote you a competitive Price and Delivery time.

All instruments are manufactured according to the recognized standard patterns currently in use in Hospital throughout the world and are being produced under restrict control of experts to avoid any flaw and to refrain any complaint at any stage.

A group of very vast experienced persons in manufacturing handling our quality Control System.

Any instruments proven defective in workmanship or material will be replaced with out charges.

We express our thanks to all our customers for the confidence they have placed us in the past. We further assure them that we will continue our best efforts to gain their confidence in the future.

We are always at your service.

Chief Executive

**SAR SONS**



## CONTENTS

**01**

**EXTRACTING FORCEPS**

**Page # 01 - 28**

**02**

**ROOT ELEVATORS**

**Page # 29 - 48**

**03**

**DIAGNOSTIC, PROBES, SCALERS, FILLING  
& LABORATORY INSTRUMENTS**

**Page # 49 - 98**

**04**

**MAXILLOFACIAL SURGERY  
INSTRUMENTS**

**Page # 99 - 124**

**05**

**ORTHODONTIC INSTRUMENTS  
& PLIERS**

**Page # 125 - 144**

**06**

**DENTAL IMPLANT INSTRUMENTS  
& Impression Tray**

**Page # 145 - 182**

**07**

**HOLLOWWARE**

**Page # 183 - 191**

## Handle Selection For Extracting Forceps

Dear Valued Buyers if any Universal Fig. No. of Extracting Forceps not Found in our Catalogue you Can Refer the Fig. No. From These Diagram.

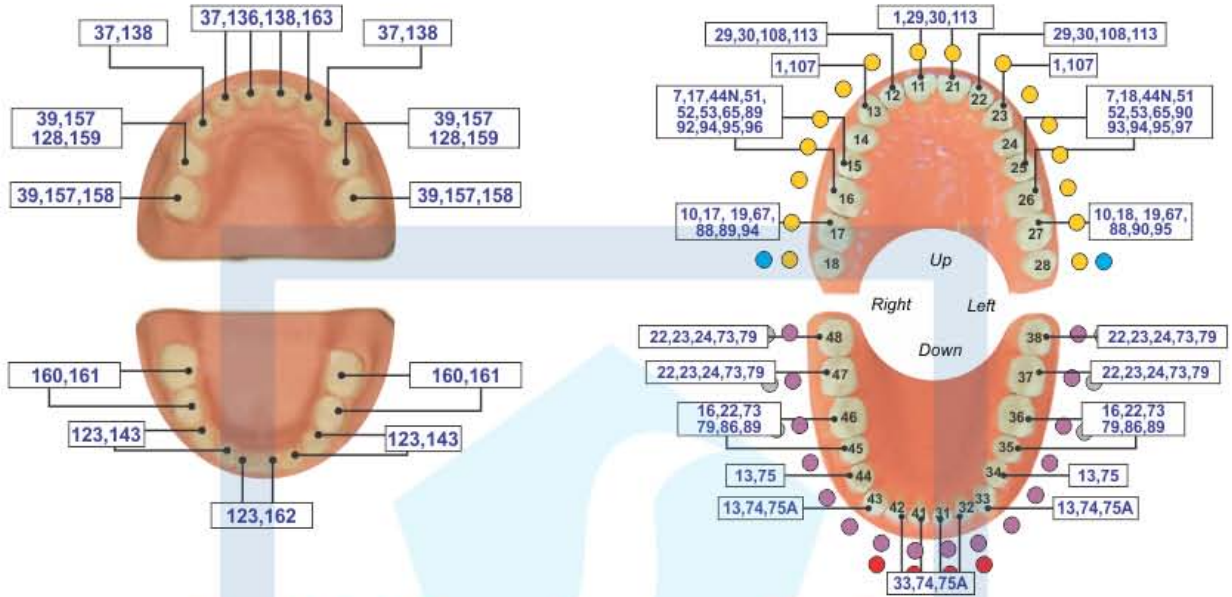

Dear Valued Buyers these are our Handle Styles



English Pattern



English Pattern



English Pattern, Anatomical Handle



American Pattern



Deep Grip Forceps With Hole Pattern



Hole Pattern



## EXTRACTING FORCEPS (English Pattern)

- Щипцы экстракционные (английская форма)
- Daviers (Forme Anglaise)
- Zahnzangen (Englische Form)
- Щипці екстракційні (англійська форма)
- Forceps de Extracción (Forme Inglesa)
- استخراج الملقط (نمط اللغة الإنجليزية)

Function: To remove teeth from bony socket



Straight extracting forceps for upper incisors and canines



Straight extracting forceps for upper incisors and canines



Straight extracting forceps for upper incisors and canines

# EXTRACTING FORCEPS (English Pattern)

- Щипцы экстракционные (английская форма)
- Щипці екстракційні (англійська форма)
- Daviers (Forme Anglaise)
- Forceps de Extracción (Forme Inglesa)
- Zahnzangen (Englische Form)
- استخراج الملقط (نمط اللغة الإنجليزية)

Function: To remove teeth from bony socket



**SAR-011**  
# 18A  
upper molars



**SAR-012**  
# 19  
upper third molars



**SAR-013**  
# 20  
lower third molar



**SAR-014**  
# 24  
lower molar, right



**SAR-015**  
# 29  
upper roots



**SAR-016**  
# 30  
Upper Roots



**SAR-017**  
# 33  
lower roots



**SAR-018**  
# 33A  
Lower Roots



**SAR-019**  
# 33M  
Lower roots  
with long beak



**SAR-020**  
# 46L



**SAR-021**  
# 51  
Upper Roots



**SAR-022**  
# 51A  
Upper Roots



Straight extracting forceps for upper incisors and canines



Straight extracting forceps for upper incisors and canines



Straight extracting forceps for upper incisors and canines

# EXTRACTING FORCEPS (English Pattern)

- Щипцы экстракционные (английская форма)
- Щипці екстракційні (англійська форма)
- Daviers (Forme Anglaise)
- Forceps de Extracción (Forme Inglesa)
- Zahnzangen (Englische Form)
- استخراج الملقط (نمط اللغة الإنجليزية)

Function: To remove teeth from bony socket

## WISDOM EXTRACTING FORCEPS



**SAR-023**  
Routerier  
(# 22 1/2 L)  
lower molars and  
wisdoms, left



**SAR-024**  
Routerier  
(# 22 1/2 R)  
lower molars and  
wisdoms, right



**SAR-029**  
# 51AL



**SAR-025**  
Routerier  
(# 33 1/2 L)  
lower molar and  
wisdom roots, left



**SAR-026**  
Routerier  
(# 33 1/2 R)  
lower molar and  
wisdom roots, right



*Routerier extracting forceps for lower molars and third molars, right*



**SAR-030**  
# 67  
Upper Thrid Molars



**SAR-032**  
# 79  
Lower Thrid Molars



**SAR-027**  
Fig. 186L  
lower molars



**SAR-028**  
Fig. 186R  
lower molars



**SAR-031**  
# 67A  
Upper Thrid Molars



*Angled extracting forceps for upper roots*

## EXTRACTING FORCEPS (English Pattern)

- Щипцы экстракционные (английская форма)
- Daviers (Forme Anglaise)
- Zahnzangen (Englische Form)
- Щипці екстракційні (англійська форма)
- Forceps de Extracción (Forme Inglesa)
- استخراج الملقط (نمط اللغة الإنجليزية)

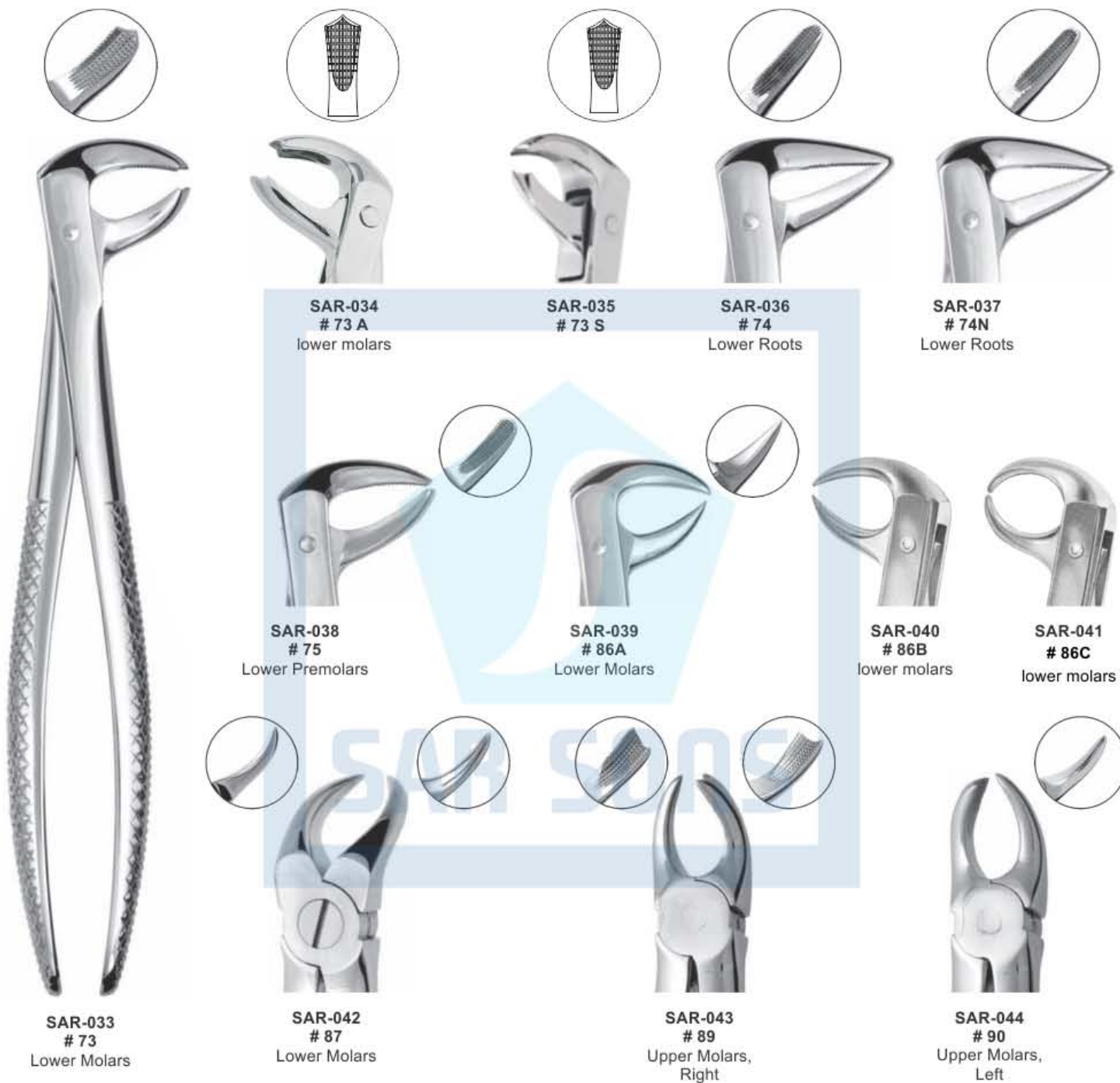

Straight extracting forceps for upper incisors and canines



Straight extracting forceps for upper incisors and canines



Straight extracting forceps for upper incisors and canines



# EXTRACTING FORCEPS (English Pattern)

- Щипцы экстракционные (английская форма)
- Daviers (Forme Anglaise)
- Zahnzangen (Englische Form)
- Щипці екстракційні (англійська форма)
- Forceps de Extracción (Forme Inglesa)
- استخراج الملقط (نمط اللغة الإنجليزية)

## SAR-TRAUMATIC EXTRACTION

Improved tapered beaks for complete root contact. Cross serrations. Deep Gripe Extracting Forceps



- No Fracture
- No Tissue Damage
- Extraction With Easy



Thin Tip

**SAR-045**  
# 34

Upper incisors and premolars deep-gripping



Wide Tip

**SAR-046**  
# 34A

Upper centrals / cains deep-gripping



Thin Tip

**SAR-047**  
Fig. 35

upper permolars deep-gripping



Wide Tip

**SAR-048**  
# 35A

Upper incisors and premolars deep-gripping



Thin Tip

**SAR-049**  
# 36

Lower premolars deep-gripping



Wide Tip

**SAR-050**  
# 36A

Lower premolars deep-gripping



**SAR-051**  
# 336

lower permolars deep-gripping



**SAR-052**  
F-7C

lower molar



**SAR-053**  
# 9

Apex Forceps Lower Universal Deep Root Pick



**SAR-054**  
# 79N

Lower third molars deep-gripping



**SAR-055**  
# 79

Lower Thrid Molars

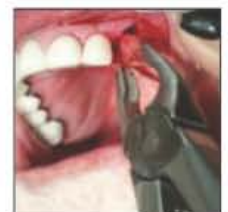

### Function:

Extraction forceps are used to further loosen teeth by rotational and tilting movements and finally to extract the teeth in combination with a fulcrum.

# EXTRACTING FORCEPS (English Pattern)

- Щипцы экстракционные (английская форма)
- Щипці екстракційні (англійська форма)
- Daviers (Forme Anglaise)
- Forceps de Extracción (Forme Inglesa)
- Zahnzangen (Englische Form)
- استخراج الملقط (نمط اللغة الإنجليزية)

## DEEP ROOT PICK FORCEPS



**SAR-056**  
**# 146**

Apex Forceps Lower Root  
Deep Root Pick



**SAR-057**  
**# 153**

Apex Forceps Upper Root  
Deep Root Pick



**SAR-058**  
**# 149**

Apex Forceps Upper Root  
Deep Root Pick



**SAR-061**  
Fig. 44



**SAR-060**  
Fig. 44Z



**SAR-059**  
Fig. 45Z



**SAR-062**  
**# 46XL**  
Apex Forceps Lower Root  
Deep Root Pick



**SAR-063**  
**# 67**  
Upper Third Molars



**SAR-064**  
**# 67A**  
Upper Third Molars



forceps for upper incisors, premolars and roots



**SAR-065**  
**# 67N**  
Lower third molars  
deep-gripping



**SAR-066**  
**# 331**  
upper roots  
deep-gripping



## EXTRACTING FORCEPS (English Pattern)

- Щипцы экстракционные (английская форма)
- Daviers (Forme Anglaise)
- Zahnzangen (Englische Form)
- Щипці екстракційні (англійська форма)
- Forceps de Extracción (Forme Inglesa)
- استخراج الملقط (نمط اللغة الإنجليزية)



Fig. 1  
upper  
laterals  
and canines



**SAR-067**  
Set of 10 Pieces  
Fig. 1  
Fig. 7  
Fig. 13  
Fig. 17  
Fig. 18  
Fig. 22  
Fig. 51A  
Fig. 67  
Fig. 74N  
Fig. 79

Fig. 7  
upper premolars



Fig. 13  
lower premolars



Fig. 17  
upper molars, right



Fig. 18  
upper molars, left



Fig. 22  
lower roots



Fig. 51A  
upper roots



Fig. 67  
upper third molars



Fig. 74N  
lower molar



Fig. 79  
lower third molars



Extracting forceps for upper roots



# EXTRACTING FORCEPS



- Щипцы экстракционные
- Daviers
- Zahnzangen
- Щипці екстракційні
- Forceps de Extracción
- استخراج المنقط

## Pediatric Tooth Extracting Forceps Set



**SAR-069**  
English Pattern Klein #51S  
Pedodontic Upper root



**SAR-068**  
English Pattern Klein #137  
Pedodontic, Upper Incisors Spring handle



**SAR-072**  
English Pattern Klein #5  
Pedodontic Lower Incisors.



**SAR-070**  
English Pattern Klein #139  
Pedodontic Upper Premolars



**SAR-073**  
English Pattern Klein #7  
Pedodontic Lower Roots,



**SAR-071**  
English Pattern Klein #3  
Pedodontic Upper Molars Universal

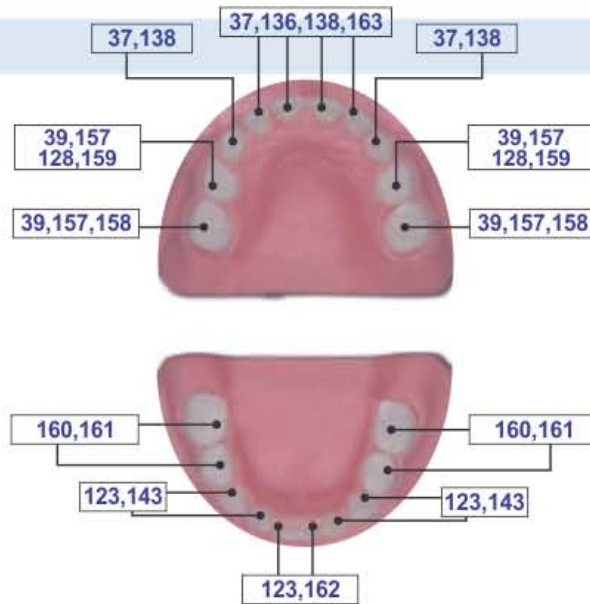

**SAR-074**  
English Pattern Klein #6  
Pedodontic Lower Molars, Spring Handle

# ROOT FRAGMENT FORCEPS



Witzel  
**SAR-076**  
170mm  
Upper roots, Universal

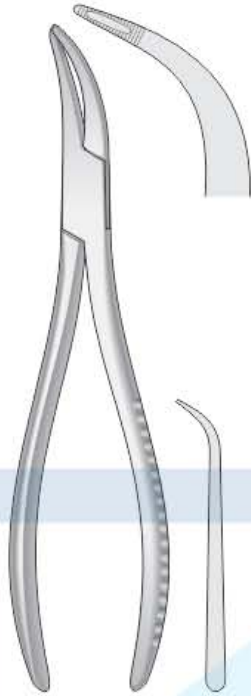

Witzel  
**SAR-077**  
165mm  
Lower roots, Universal



**SAR-078**  
#400(300)  
165mm  
Upper roots, Universal



**SAR-079**  
#401(301)  
160mm  
Lower roots, Universal



**SAR-080**  
Witzel Forceps With Gold  
Set of 3 Pcs



**SAR-084**  
Witzel Forceps With Hole And Screw Pattern  
Set of 3 Pcs



**SAR-088**  
Witzel Forceps With Anatomical Handle  
Set of 3 Pcs



**SAR-081**  
#401(301)  
160mm  
Lower roots, Universal



**SAR-085**  
#401(301)  
160mm  
Lower roots, Universal



**SAR-089**  
#401(301)  
160mm  
Lower roots, Universal



**SAR-082**  
#400(300)  
165mm  
Upper roots, Universal



**SAR-086**  
#400(300)  
165mm  
Upper roots, Universal



**SAR-090**  
#400(300)  
165mm  
Upper roots, Universal



Witzel  
**SAR-083**  
165mm  
Lower roots, Universal



Witzel  
**SAR-087**  
165mm  
Lower roots, Universal



Witzel  
**SAR-091**  
165mm  
Lower roots, Universal

## ROOTS SPLINTER FORCEPS

- Щипцы для удаления корневых осколков
- Pincas Fragments
- Wurzelsplitterzangen
- Щипці для видалення корневих осколків
- Pinzas Para Fragmentos
- جوار منشقة الملقط



**SAR-092**  
Splinter Forceps  
15.5cm



*Stieglitz Root Splinter Forceps*



**SAR-093**  
Splinter Forceps  
15.5cm 45°



**SAR-094**  
Stieglitz  
Root Fragments



**SAR-095**  
Stieglitz  
Root Fragments

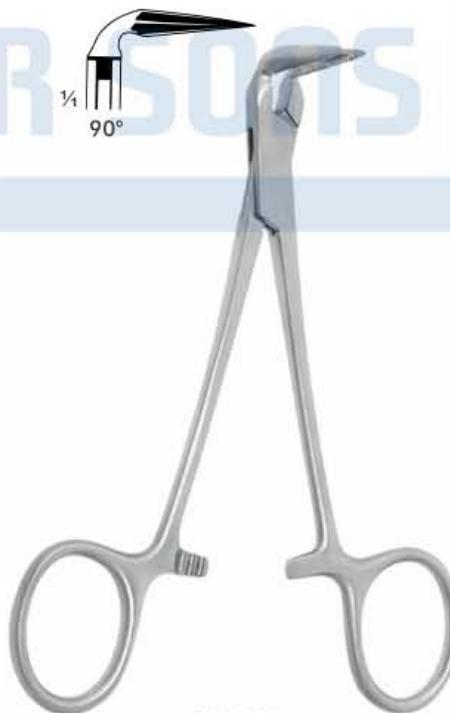

**SAR-096**  
Stieglitz Splinter Forceps  
140mm 90°



**SAR-097**  
Stieglitz Splinter Forceps  
140mm Straight

# ROOT FRAGMENT FORCEPS

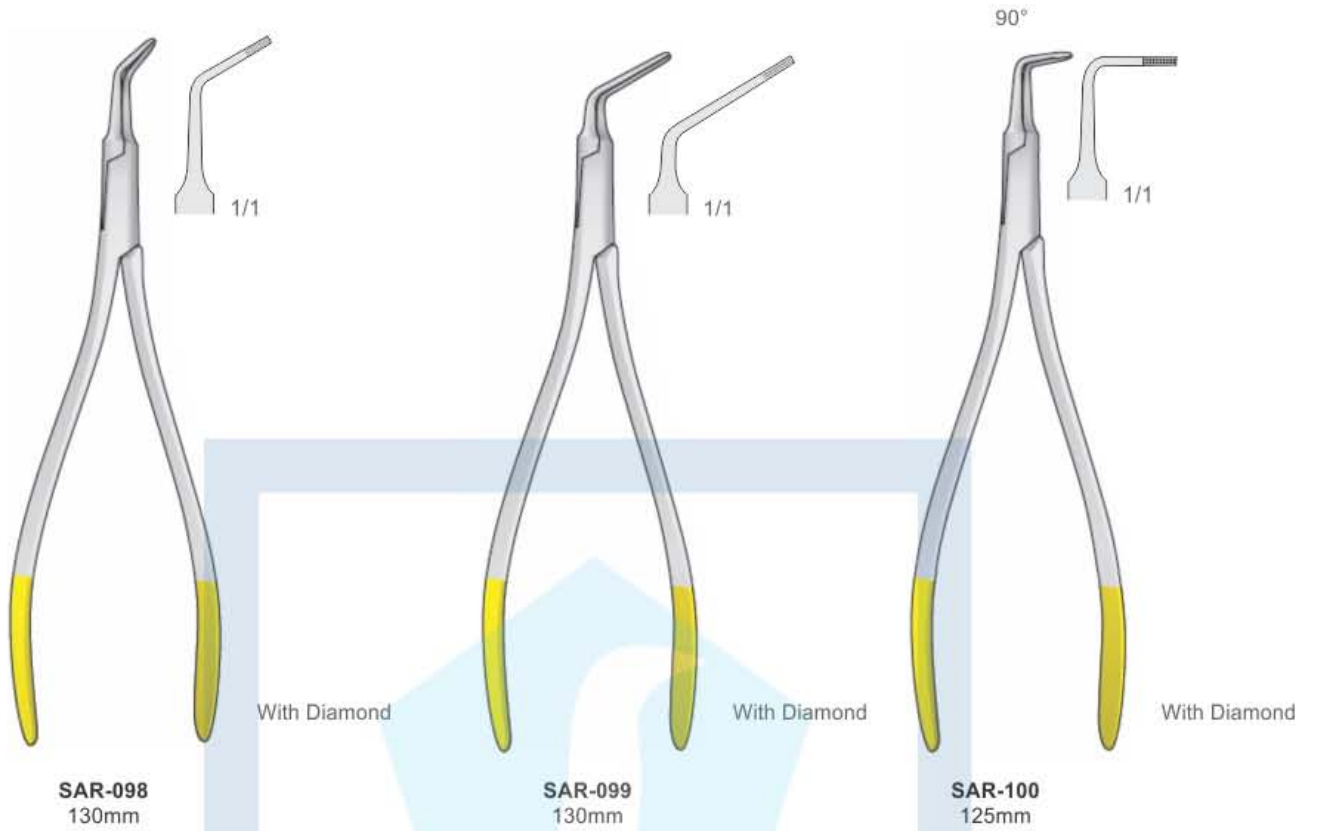

## EXTRACTING FORCEPS (American Pattern)

- Щипцы экстракционные (американская форма)
- Щипці екстракційні (американська форма)
- Daviers - forme américaine
- Pinzere per estrazione - forma americana
- Fórceps de extracción - forma americana
- استخراج الملقط (النمط الأمريكي)



**SAR-104**  
# 1STD  
Winter  
upper centrals and canines

**SAR-105**  
Fig. 1  
upper incisors  
and roots

**SAR-106**  
Cryer  
Fig. 150



## EXTRACTING FORCEPS (American Pattern)

- Щипцы экстракционные (американская форма)
- Щипці екстракційні (американська форма)
- Daviers - forme américaine
- Pinzeper per estrazione - forma americana
- Fórceps de extracción - forma americana
- استخراج الملقط (النمط الأمريكي)



**SAR-108**  
Fig. 62  
incisors, premolars,  
deciduous teeth



**SAR-109**  
# 10S  
upper roots



**SAR-110**  
# 17  
lower molars

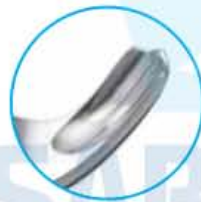

**SAR-111**  
Harris  
Fig. 18R

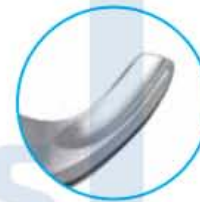

**SAR-112**  
Harris  
Fig. 18L

**SAR-107**  
Fig. 150A  
Cryer  
upper incisors, premolars, roots

## EXTRACTING FORCEPS (American Pattern)

- Щипцы экстракционные (американская форма)
- Daviers - forme américaine
- Fórceps de extracción - forma americana
- Щипці екстракційні (американська форма)
- Pinzere per estrazione - forma americana
- استخراج المنقط (الأمريكي)

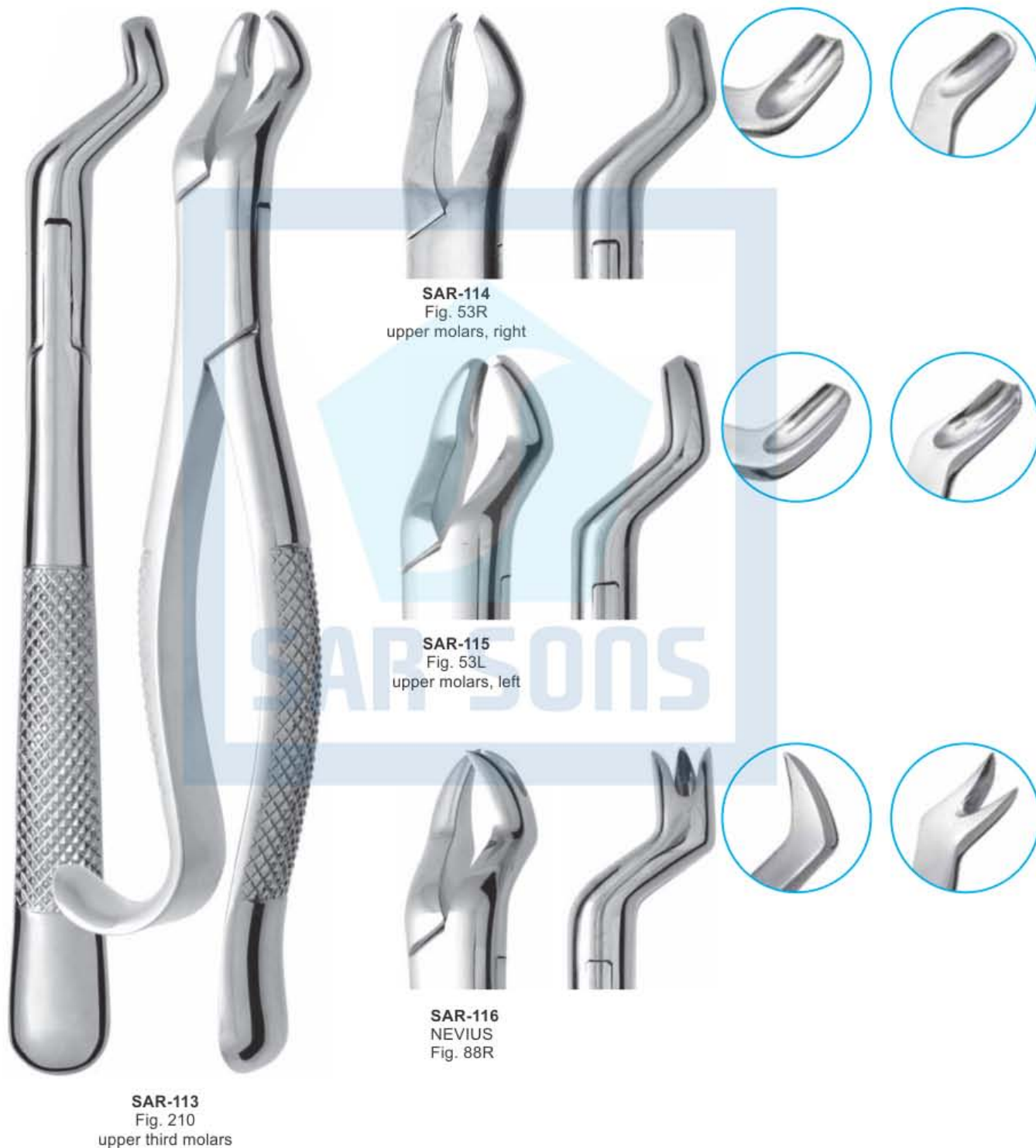

## EXTRACTING FORCEPS (American Pattern)

- Щипцы экстракционные (американская форма)
- Щипці екстракційні (американська форма)
- Daviers - forme américaine
- Pinzere per estrazione - forma americana
- Fórceps de extracción - forma americana
- استخراج الملقط (النمط الأمريكي)



**SAR-117**  
Fig. 24  
upper molars



**SAR-118**  
# 210S  
upper third molars



**SAR-119**  
# 210H  
upper third molars



**SAR-120**  
# 286  
Upper Roots,  
Premolars, Incisors



**SAR-121**  
# 99C  
Kells  
upper incisors,  
canines, premolars



**SAR-122**  
# 222  
lower third molars



**SAR-123**  
# 286  
Lower Molar

## EXTRACTING FORCEPS (American Pattern)

- Щипцы экстракционные (американская форма)
- Daviers - forme américaine
- Fórceps de extracción - forma americana
- Щипці екстракційні (американська форма)
- Pinzere per estrazione - forma americana
- استخراج المنقط (النمط الأمريكي)



## EXTRACTING FORCEPS (American Pattern)

- Щипцы экстракционные (американская форма)
- Щипці екстракційні (американська форма)
- Daviers - forme américaine
- Pinzeper per estrazione - forma americana
- Fórceps de extracción - forma americana
- استخراج الملقط (النمط الأمريكي)

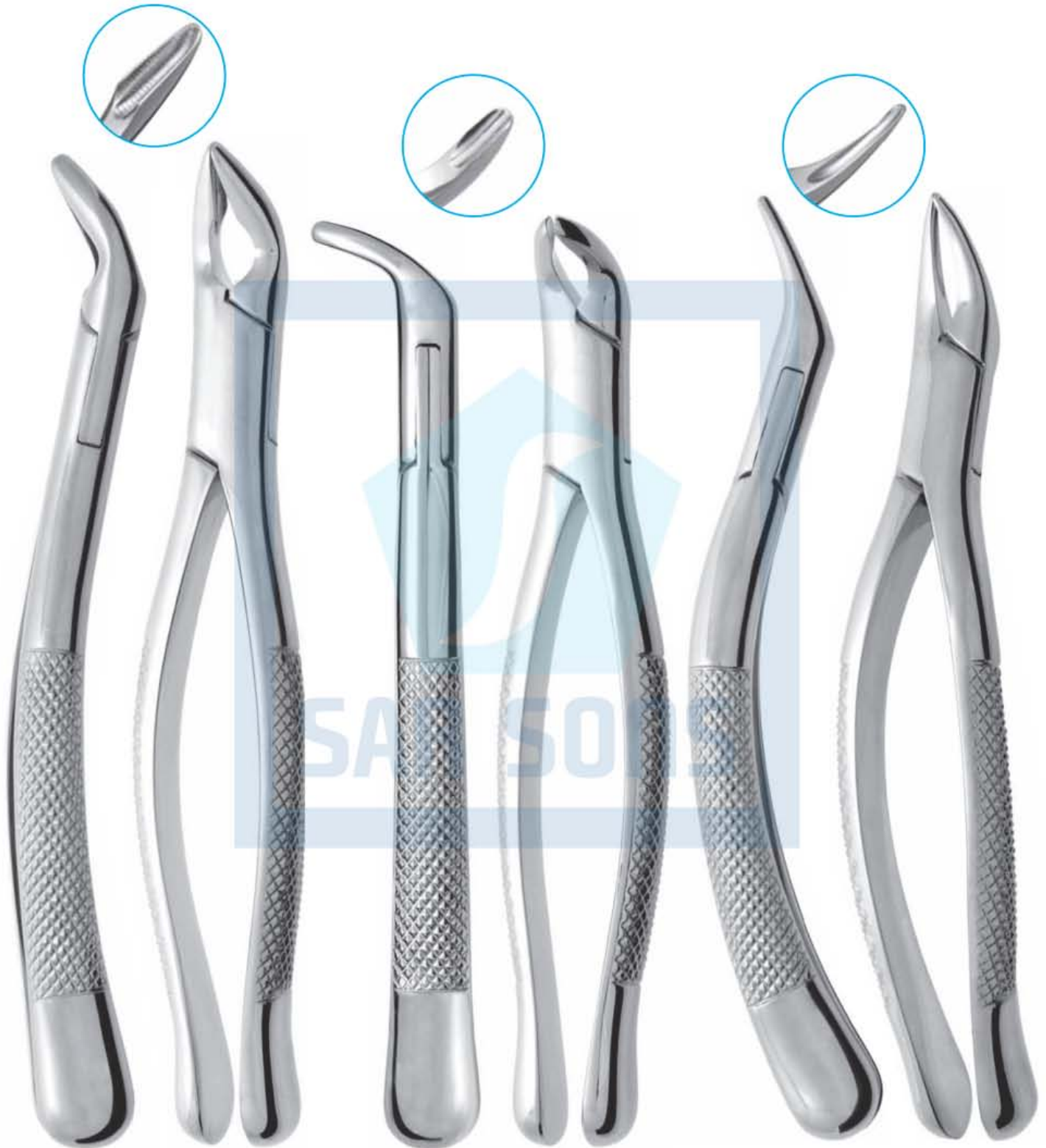

**SAR-128**  
COHEN  
universal

**SAR-129**  
Fig. 203  
lower incisors  
and roots

**SAR-130**  
Tomes Fig. 69  
upper and lower  
roots

## EXTRACTING FORCEPS (American Pattern)



- Щипцы экстракционные (американская форма)
- Щипці екстракційні (американська форма)
- Daviers - forme américaine
- Pinzereper per estrazione - forma americana
- Fórceps de extracción - forma americana
- استخراج الملقط (النمط الأمريكي)



**SAR-131**  
Fig. 23  
lower molars

**SAR-132**  
Fig. 16  
lower molars

**SAR-133**  
Physic Fig. 5  
lower third molars

**SAR-134**  
Harris Fig. 15  
lower molars

**SAR-135**  
Fig. 103

## EXTRACTING FORCEPS (American Pattern)

- Щипцы экстракционные (американская форма)
- Щипці екстракційні (американська форма)
- Daviers - forme américaine
- Pinzere per estrazione - forma americana
- Fórceps de extracción - forma americana
- استخراج الملقط (النمط الأمريكي)



**SAR-136**  
Hull  
Fig. 101  
Deciduous teeth

**SAR-137**  
Cryer  
Fig. 150S  
upper teeth,  
for children

**SAR-138**  
Fig. 150 AS

## EXTRACTING FORCEPS (American Pattern)

- Щипцы экстракционные (американская форма)
- Щипці екстракційні (американська форма)
- Daviers - forme américaine
- Pinzere per estrazione - forma americana
- Fórceps de extracción - forma americana
- استخراج الملقط (النمط الأمريكي)



**SAR-139**  
Cryer  
Fig. 151  
lower teeth,  
for children

**SAR-140**  
Fig. 151 S  
lower incisors,  
premolars, roots

**SAR-141**  
Fig. 151 AS



## EXTRACTING FORCEPS (American Pattern)

- Щипцы экстракционные (американская форма)
- Щипці екстракційні (американська форма)
- Daviers - forme américaine
- Pinzere per estrazione - forma americana
- Fórceps de extracción - forma americana
- استخراج الملقط (النمط الأمريكي)



**SAR-142**  
**# 16S**  
lower molars for children



**SAR-143**  
**# 17S**  
lower molars



**SAR-144**  
**# 23 S**  
Lower molars

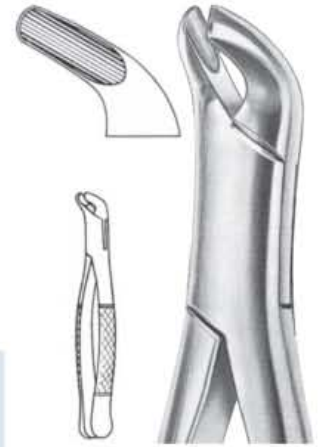

**SAR-145**  
**# 27**  
lower molars



**SAR-146**  
**# 18LS**  
upper molars left



**SAR-147**  
**# 18RS**  
upper molars right

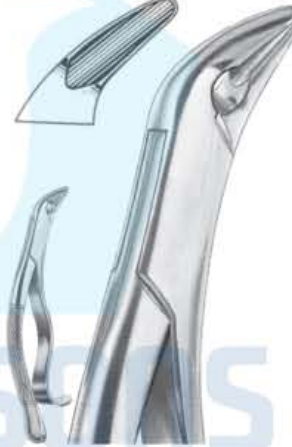

**SAR-148**  
**# 85 Tomas**  
lower canines, premolars and molars

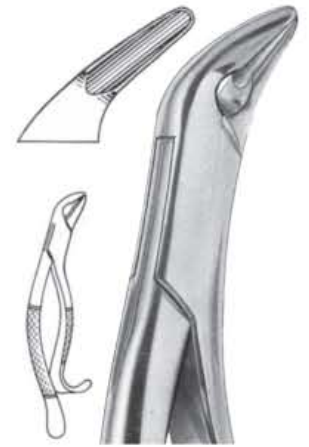

**SAR-149**  
**# 85A Tomas**  
lower canines, premolars and molars



**SAR-150**  
**# 69S**  
upper and lower roots



**SAR-151**  
**# 99A Kells**  
upper incisors, canines, premolars



**SAR-152**  
**# 217**  
lower molars

## EXTRACTING FORCEPS (American Pattern)



- Щипцы экстракционные (американская форма)
- Давиеры - forme américaine
- Fórceps de extracción - forma americana
- Щипці екстракційні (американська форма)
- Pinzere per estrazione - forma americana
- استخراج المنقط (النمط الأمريكي)



**SAR-153**  
**#10 SK**  
Upper Molars Sup



**SAR-154**  
**#17 SK Universal**  
Lower Molars

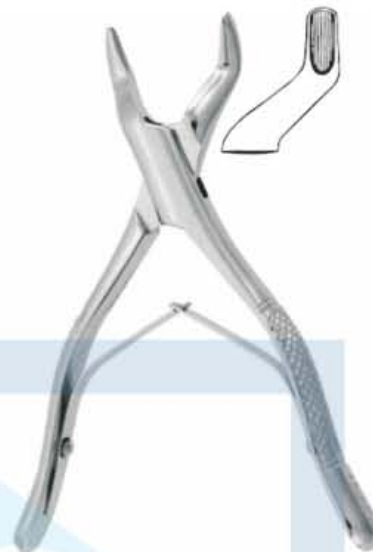

**SAR-155**  
**#23 SK Universal**  
Upper Molars



**SAR-156**  
**#69 SK Tomas**  
upper and lower roots



**SAR-157**  
**#99 SK**  
upper incisors,  
canines, premolars



**SAR-158**  
**#150 SK**  
upper incisors,  
premolars, roots



**SAR-159**  
**#151 SK**  
lower incisors,  
premolars, roots



**SAR-160**  
**#222 SK**  
lower third molars

## EXTRACTING FORCEPS (American Pattern)

- Щипцы экстракционные (американская форма)
- Давиеры - forme américaine
- Fórceps de extracción - forma americana
- Щипці екстракційні (американська форма)
- Pinzeper per estrazione - forma americana
- استخراج الملقط (النمط الأمريكي)



**SAR-161**  
Fig. 1  
Upper Anterior

**SAR-162**  
Lower Molar  
Fig. 23 Cow Horn



**SAR-163**  
Fig. 74  
Lower Anterior



**SAR-164**  
Fig. 88L  
Upper Molar Left



**SAR-165**  
Fig. 88R  
Upper Molar Right



**SAR-166**  
Fig. 74  
Lower Anterior



**SAR-167**  
Fig. 106  
Lower Incisors



**SAR-168**  
Fig. 174  
Extra Narrow  
Lower Anterior  
Apical Retention  
Forceps



**SAR-169**  
Fig. 859  
Lower Molars  
Roots



## EXTRACTING FORCEPS (American Pattern)

- Щипцы экстракционные (американская форма)
- Щипці екстракційні (американська форма)
- Daviers - forme américaine
- Pinzeper per estrazione - forma americana
- Fórceps de extracción - forma americana
- استخراج الملقط (النمط الأمريكي)

### Carbide Diamond Coated Point



**SAR-170**  
150 T.C.  
Carbide Serrated Beak  
Upper Incisors, Cuspids,  
Bicuspid & Roots,  
Universal



**SAR-171**  
151 T.C.  
Carbide Serrated Beak  
Lower Incisors, Cuspids,  
Bicuspid & Roots, Universal



**SAR-172**  
151STD T.C.  
Carbide Serrated Beak  
Upper Incisors, Cuspids,



**SAR-173**  
17 T.C.  
Carbide Serrated Beak  
1st & 2nd Lower Molars,  
Universal



**SAR-174**  
53L T.C.  
Carbide Serrated Beak  
1st & 2nd Upper Molars,  
Left

**SAR-175**  
53R T.C.  
Carbide Serrated Beak  
1st & 2nd Upper Molars,  
Right



**SAR-176**  
65 T.C.  
Carbide Serrated Beak  
Upper Incisors, Roots &  
Fragments



**SAR-177**  
69 T.C.  
Carbide Serrated Beak  
Upper & Lower Fragments  
And Roots



**SAR-178**  
150S T.C. Pedro forcep  
Carbide Serrated Beak  
Pedo, Upper Primary Teeth  
and Roots, Universal



**SAR-179**  
151S T.C. Pedro forcep  
Carbide Serrated Beak  
Pedo, Lower Primary Teeth  
and Roots, Universal

## BONE ROUNGER

- Костные кусачки
- Hohlmeißelzangen
- Pincés-gouges
- Кусачки для кісток
- Pinzas-gubias
- روتجورس العظام



**SAR-180**  
Blumenthal  
15cm



**SAR-181**  
Blumenthal  
15cm



**SAR-182**  
Blumenthal  
15cm



**SAR-183**  
Friedman  
14cm



**SAR-184**  
Friedman  
14.5cm



**SAR-185**  
Micro-Friedman  
14cm



**SAR-186**  
Micro-Friedman  
15cm



**SAR-187**  
Micro-Friedman  
16cm



**SAR-188**  
Kleinert-Kutz  
18.5cm



**SAR-189**  
Beyer  
18.5cm



**SAR-190**  
Mead 1A  
18.5cm



**SAR-191**  
Luer  
18.5cm

## EXTRACTING FORCEPS (English Pattern)

- Щипцы экстракционные (английская форма)
- Щипці екстракційні (англійська форма)
- Daviers (Forme Anglaise)
- Forceps de Extracción (Forme Inglesa)
- Zahnzangen (Englische Form)
- استخراج الملقط (نمط اللغة الإنجليزية)

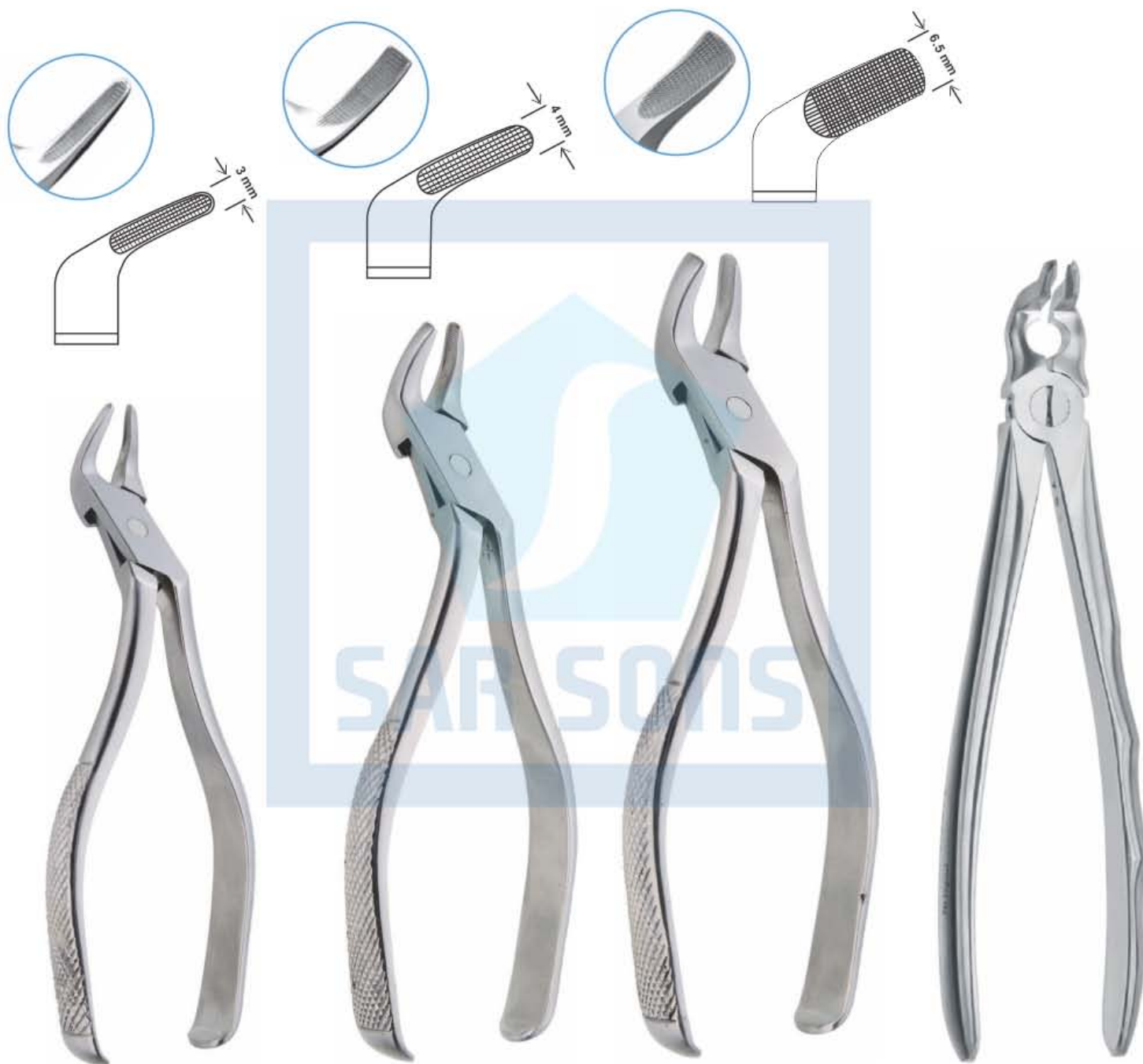

**SAR-192**  
Meissner  
Extracting Forceps

**SAR-193**  
Meissner  
Extracting Forceps

**SAR-194**  
Meissner  
Extracting Forceps

**SAR-195**  
Comellas Forceps  
Anatomical Handle

# DENTAL SYRINGES

- Шприцы стоматологические карпульные
- Шприці стоматологічні карпульні
- Seringues à usage dentaire
- Jeringas dentales
- Dentalspritzen
- المحاقن الأسنان



SAR-196 1.8ml  
SAR-197 2.2ml



SAR-198 1.8ml  
SAR-199 2.2ml



SAR-200 1.8ml  
SAR-201 2.2ml



SAR-202 1.8ml  
SAR-203 2.2ml



SAR-204 1.8ml  
SAR-205 2.2ml



SAR-206 1.8ml  
SAR-207 2.2ml



SAR-208  
# 1001  
Intraligamental  
Anesthesia  
Syringe in  
Black Colour



SAR-209 1.8ml  
SAR-210 2.2ml  
Angled



SAR-211  
Aluminium - Dark 1.8 ml

-  SAR-212 Aluminium - Silver 1.8 ml
-  SAR-213 Aluminium - Orange 1.8 ml
-  SAR-214 Aluminium - Green 1.8 ml
-  SAR-215 Aluminium - Blue 1.8 ml



Type C  
SAR-216 1,8ml  
SAR-217 2,2ml



Type C  
SAR-218 1,8ml  
SAR-219 2,2ml



2-Ring  
SAR-220 1,8ml  
SAR-221 2,2ml



Aspirating Syringe  
SAR-222 1.8mm  
SAR-223 2.2mm



Cartridge Syringe  
SAR-224 1.8mm  
SAR-225 2.2mm



Cartridge Syringe  
SAR-226 1.8mm  
SAR-227 2.2mm



Cartridge Syringe  
SAR-228 1.8mm  
SAR-229 2.2mm

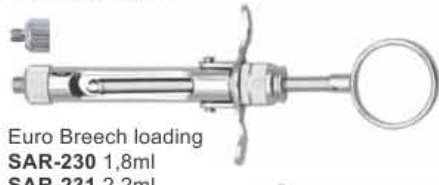

Euro Breech loading  
SAR-230 1,8ml  
SAR-231 2,2ml

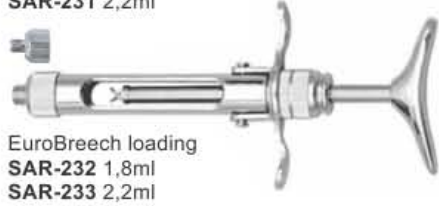

EuroBreech loading  
SAR-232 1,8ml  
SAR-233 2,2ml



Manual Aspirating Syringe  
SAR-234 1,8ml  
SAR-235 2,2ml



Quatro  
SAR-236 1,8ml  
SAR-237 2,2ml



Trio  
SAR-238 1,8ml  
SAR-239 2,2ml



Swedish Type  
SAR-240 1,8ml  
SAR-241 2,2ml



Ject Ultima  
SAR-242 1,8ml  
SAR-243 2,2ml  
Injects 0.05 ml with every click Supplied with angled and straight tubes



Ject angled  
SAR-244 1,8ml  
SAR-245 2,2ml

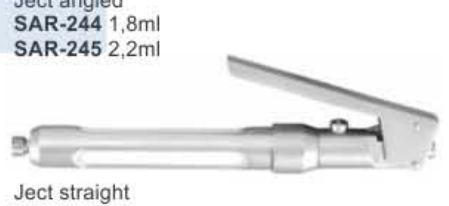

Ject straight  
SAR-246 1,8ml  
SAR-247 2,2ml



Disc System  
SAR-248 1,8ml  
SAR-249 2,2ml



Disc System  
SAR-250 1,8ml

# EXTRACTING FORCEPS SET



Извлечение щипцов  
Ensemble de pinces d'extraction  
• Zange sammeln

• Витягуючий комплект щипців  
• Extracción del conjunto de fórceps  
• استخراج ملقط مجموعة



**SAR-251**  
Extracting Forceps  
Set of 10 Pieces  
Extracting Forceps Fig. 2  
Extracting Forceps Fig. 7  
Extracting Forceps Fig. 13  
Extracting Forceps Fig. 17  
Extracting Forceps Fig. 18  
Extracting Forceps Fig. 22  
Extracting Forceps Fig. 33  
Extracting Forceps Fig. 51A  
Extracting Forceps Fig. 67A  
Extracting Forceps Fig. 79

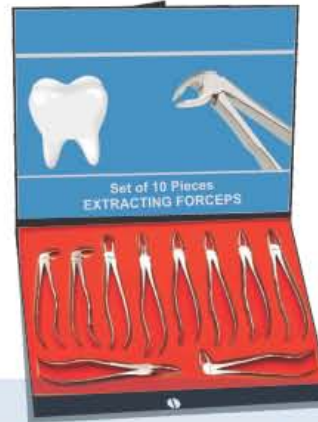

**SAR-252**  
Extracting Forceps  
Set of 10 Pieces  
Extracting Forceps Fig. 2  
Extracting Forceps Fig. 7  
Extracting Forceps Fig. 13  
Extracting Forceps Fig. 17  
Extracting Forceps Fig. 18  
Extracting Forceps Fig. 22  
Extracting Forceps Fig. 33  
Extracting Forceps Fig. 51A  
Extracting Forceps Fig. 67A  
Extracting Forceps Fig. 79



**SAR-253**  
Extracting Forceps  
Set of 13 Pieces  
Extracting Forceps Fig. 2  
Extracting Forceps Fig. 7  
Extracting Forceps Fig. 13  
Extracting Forceps Fig. 17  
Extracting Forceps Fig. 18  
Extracting Forceps Fig. 22  
Extracting Forceps Fig. 33  
Extracting Forceps Fig. 51A  
Extracting Forceps Fig. 67A  
Extracting Forceps Fig. 79  
Extracting Forceps Fig. 86C  
Extracting Forceps Fig. 89  
Extracting Forceps Fig. 90



**SAR-254**  
Extracting Forceps Children Pattern  
Set of 10 Pieces  
Extracting Forceps Fig. 13S  
Extracting Forceps Fig. 22S  
Extracting Forceps Fig. 30S  
Extracting Forceps Fig. 33S  
Extracting Forceps Fig. 37  
Extracting Forceps Fig. 38  
Extracting Forceps Fig. 39  
Extracting Forceps Fig. 39L  
Extracting Forceps Fig. 39R  
Extracting Forceps Fig. 51S



**SAR-255**  
Extracting Forceps English adult Adult  
Set of 10 Pcs



**SAR-256**  
Extracting Forceps American Adult  
Set of 10 Pcs



**SAR-257**  
Extracting Forceps American Adult  
Set of 8 Pcs



**SAR-258**  
Extracting Forceps Pedro  
Set of 7 Pcs



# ROOT ELEVATOR

## FUNCTION OF ROOT ELEVATORS IN SURGERY

To Loosen Tooth or Root From Bony Socket Prior to Placement of The Extraction Forceps.

HANDLES FOR ROOT ELEVATORS POINTS A, B, C, D, E, F, G, H



# ROOT ELEVATOR

- Элеватор корневой экстракционный
- Elévateurs à racines
- Wurzelheber
- Слеватор корневий екстракційний
- Elevadores para raices
- المصاعد الجذر

## Function of Root Elevators:

To loosen tooth or root from bony socket prior to placement of the extraction forceps.

### Apexo Root Elevators



Apexo

### Luxator Root Elevators



Luxator

upper root elevator

upper root elevator

Upper root elevator with helicoidal tip

### Bein Root Elevators

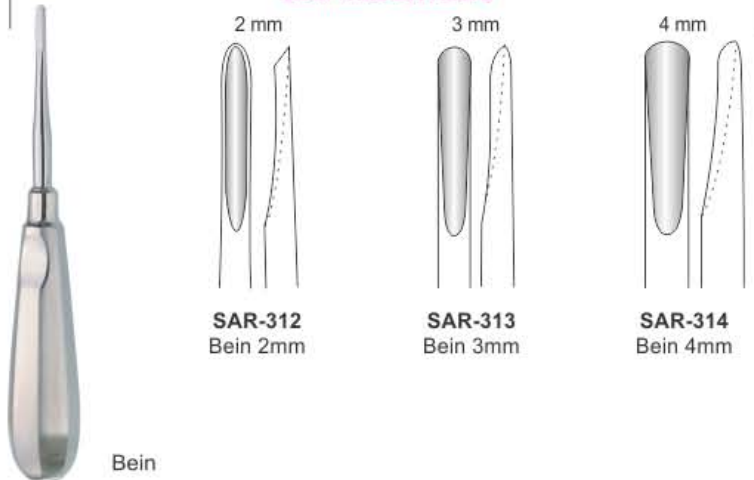

Bein

### Seldin Root Elevators

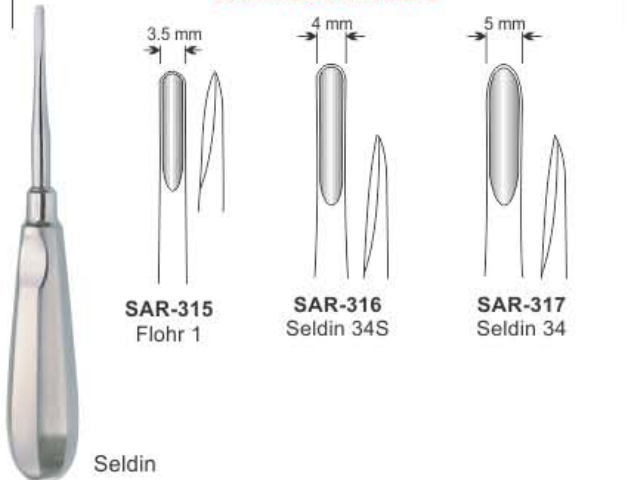

Seldin

# ROOT ELEVATOR

- Элеватор корневой экстракционный
- Слеватор кореневий екстракційний
- Elévateurs à racines
- Elevadores para raices
- Wurzelheber
- المصاعد الجذر

**FUNCTION:** To loosen tooth or root from bony socket prior to placement of the extraction forceps.

## Laxutor Root Elevators

Long Type



Laxutor Root Elevator

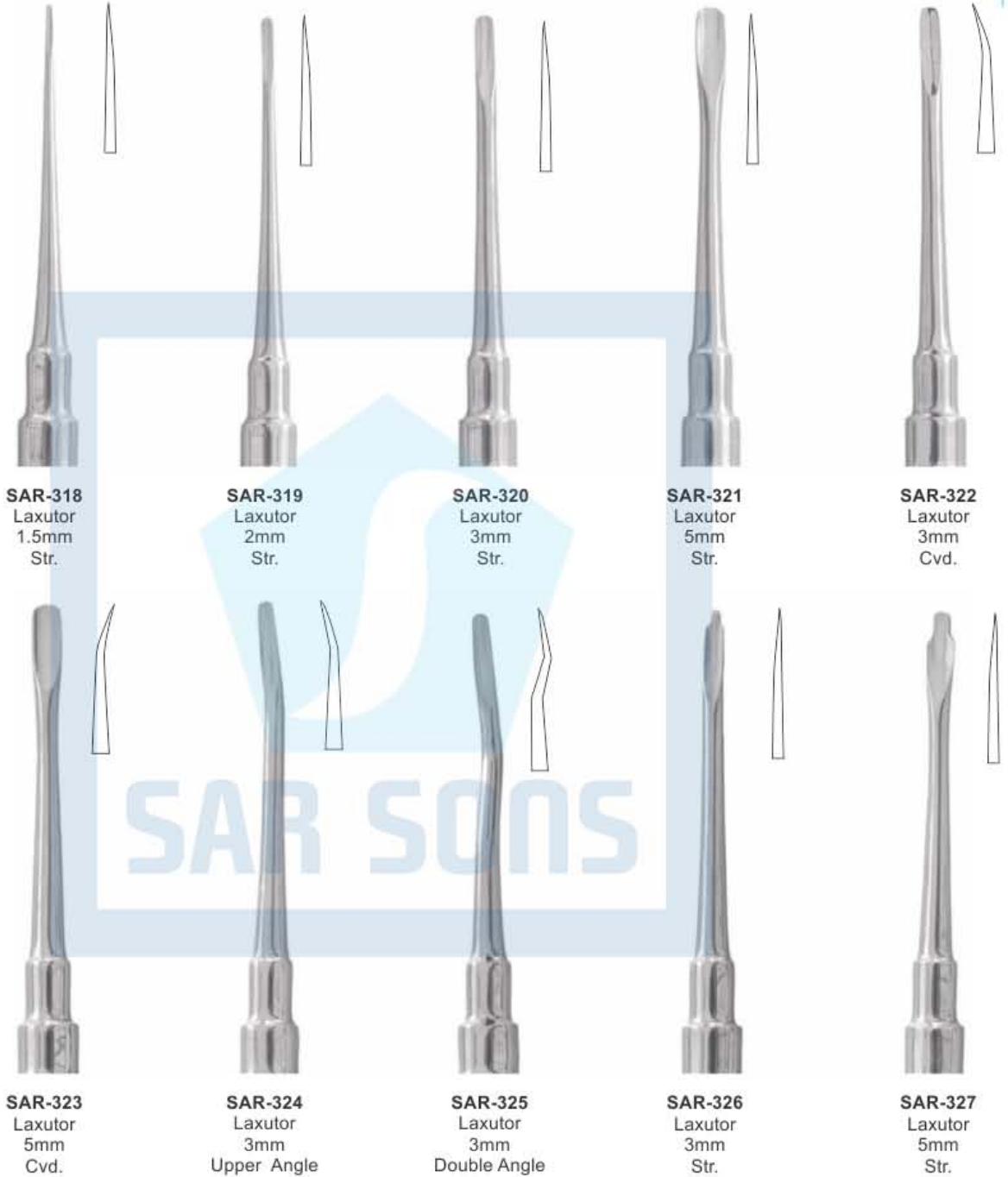

# ROOT ELEVATOR

- Элеватор корневой экстракционный
- Elévateurs à racines
- Wurzelheber
- Слеватор корневий экстракційний
- Elevadores para raices
- المصاعد الجذر

## Laxutor Root Elevators

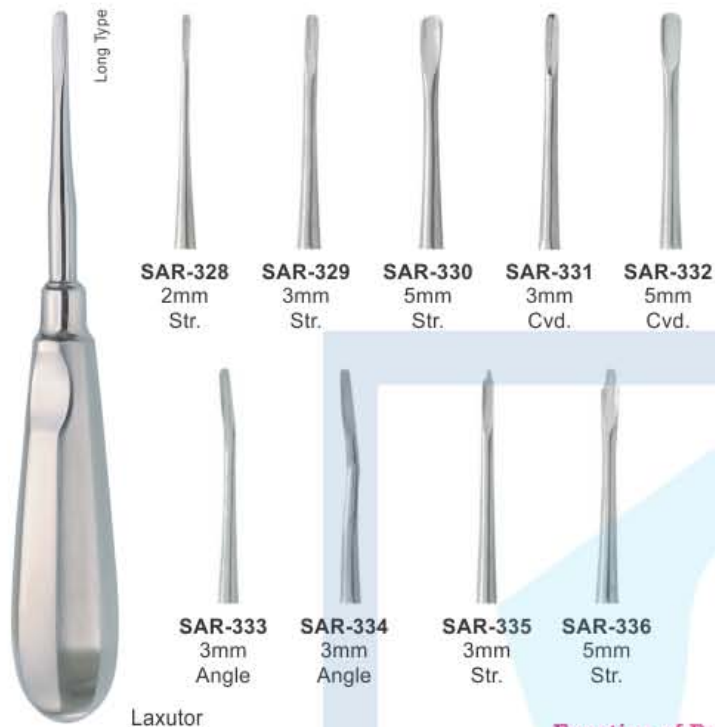

lower roots elevator



Upper root elevator with helicoidal tip

## Luxator Roots Elevator

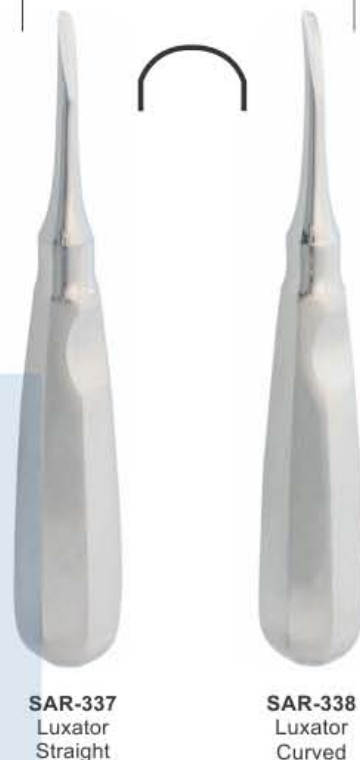

SAR-337  
Luxator  
Straight

SAR-338  
Luxator  
Curved

### Function of Root Elevators:

To loosen tooth or root from bony socket prior to placement of the extraction forceps.

## Apical Root Elevators

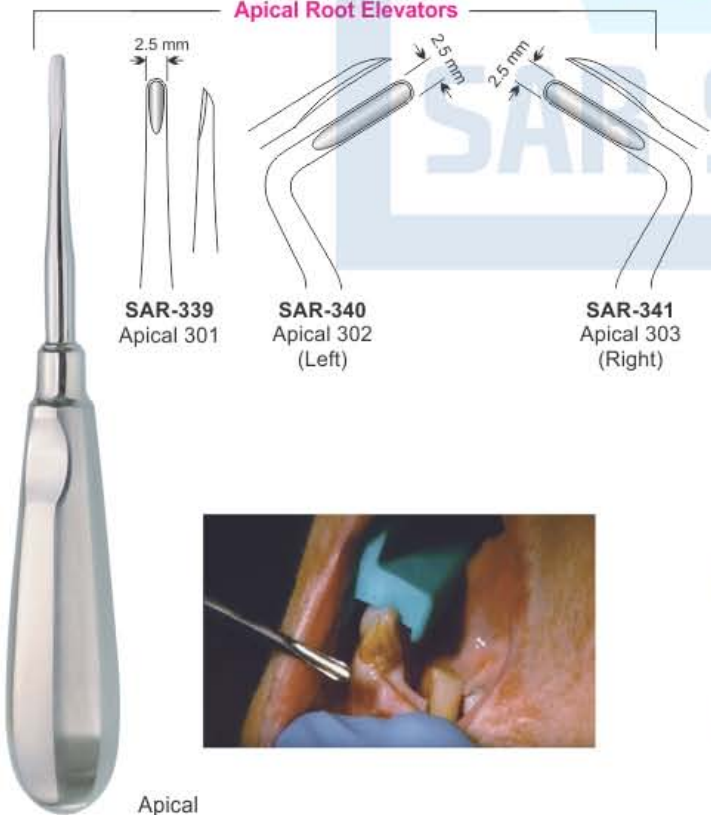

SAR-339  
Apical 301

SAR-340  
Apical 302  
(Left)

SAR-341  
Apical 303  
(Right)



Apical

## Apical Root Elevators

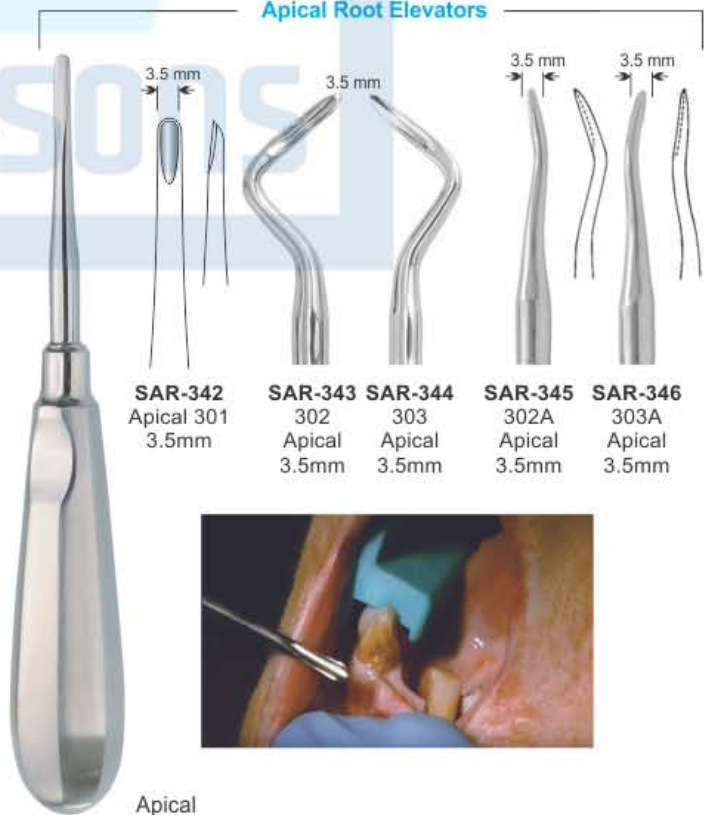

SAR-342  
Apical 301  
3.5mm

SAR-343  
302  
Apical  
3.5mm

SAR-344  
303  
Apical  
3.5mm

SAR-345  
302A  
Apical  
3.5mm

SAR-346  
303A  
Apical  
3.5mm



Apical

# ROOT ELEVATOR

- Элеватор корневой экстракционный
- Elévateurs à racines
- Wurzelheber
- Слеватор корневий экстракційний
- Elevadores para raices
- المصاعد الجذر

**FUNCTION:** To Loosen Tooth or Root From Bony Socket Prior to Placement of The Extraction Forceps.

## Cryer Root Elevators

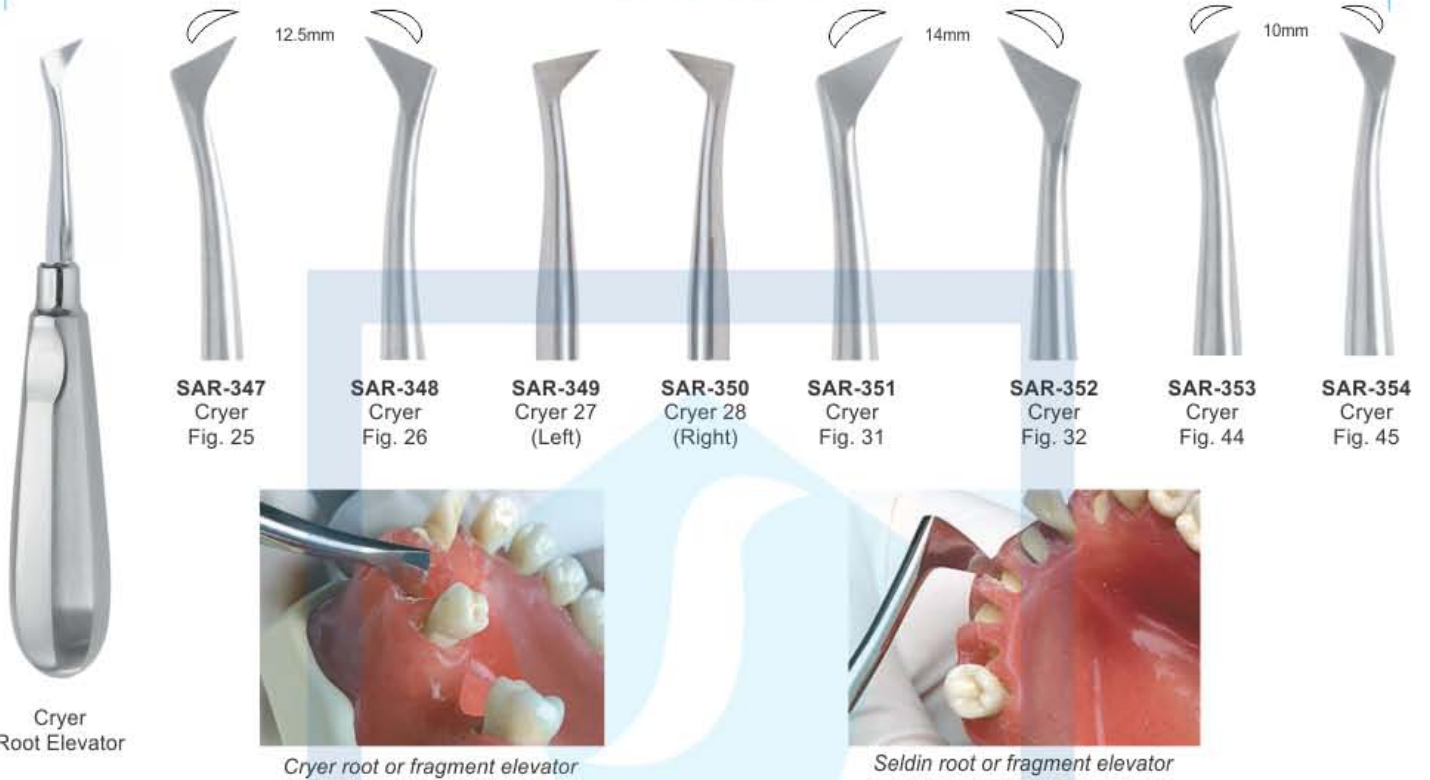

## Seldin Root Elevators



# ROOT ELEVATOR

- Элеватор корневой экстракционный
- Elévateurs à racines
- Wurzelheber
- Слеватор корневий экстракційний
- Elevadores para raices
- المصاعد الجذر

**FUNCTION:** To Loosen Tooth or Root From Bony Socket Prior to Placement of The Extraction Forceps.

## Apical Root Elevators

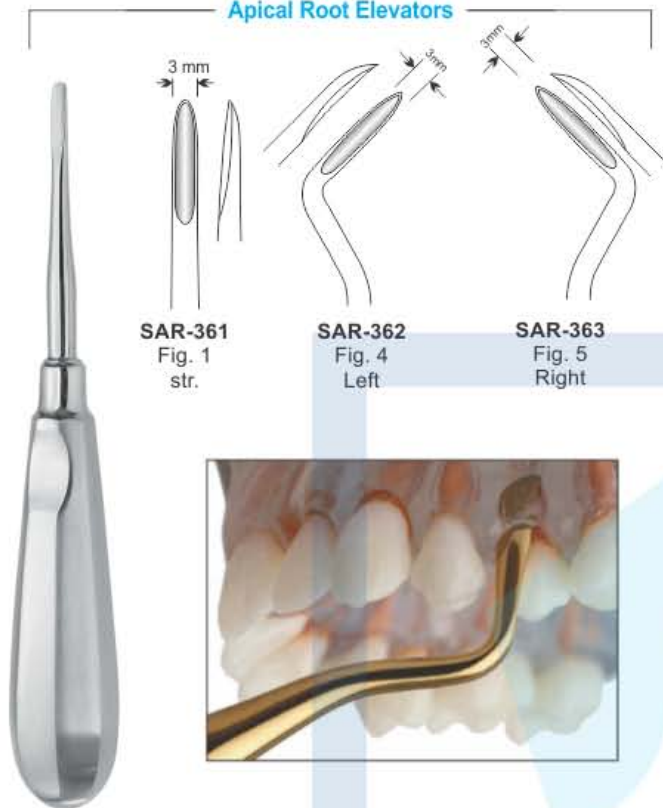

## Apical Root Elevators

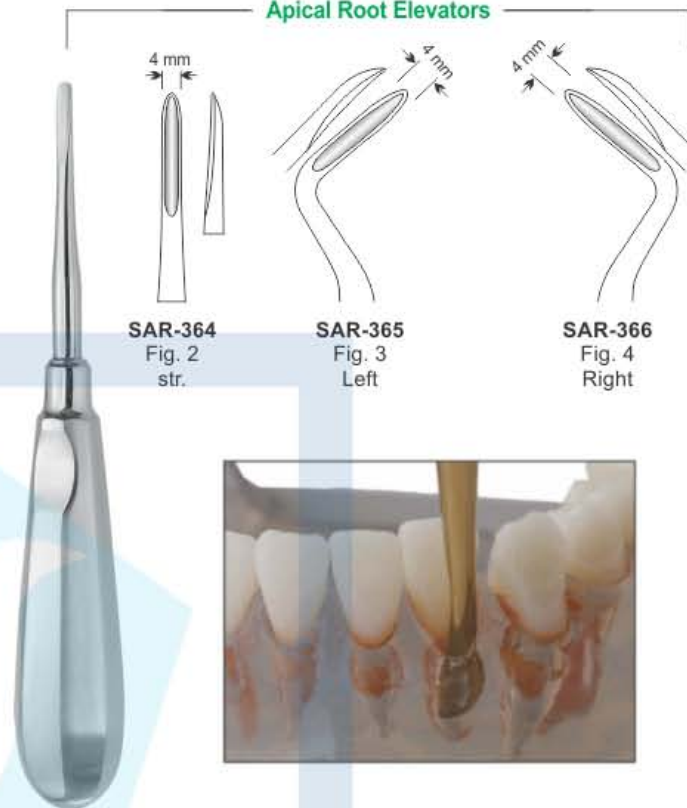

## Flohr Root Elevators



## Heidbrink Root Elevators

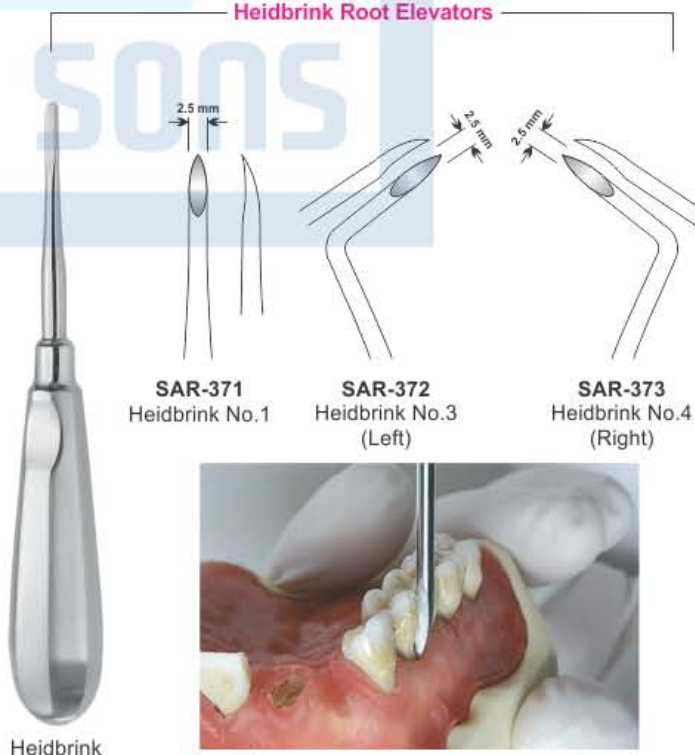

# ROOT ELEVATOR

- Элеватор корневой экстракционный
- Elévateurs à racines
- Wurzelheber
- Слеватор корневий экстракційний
- Elevadores para raices
- المصاعد الجذر

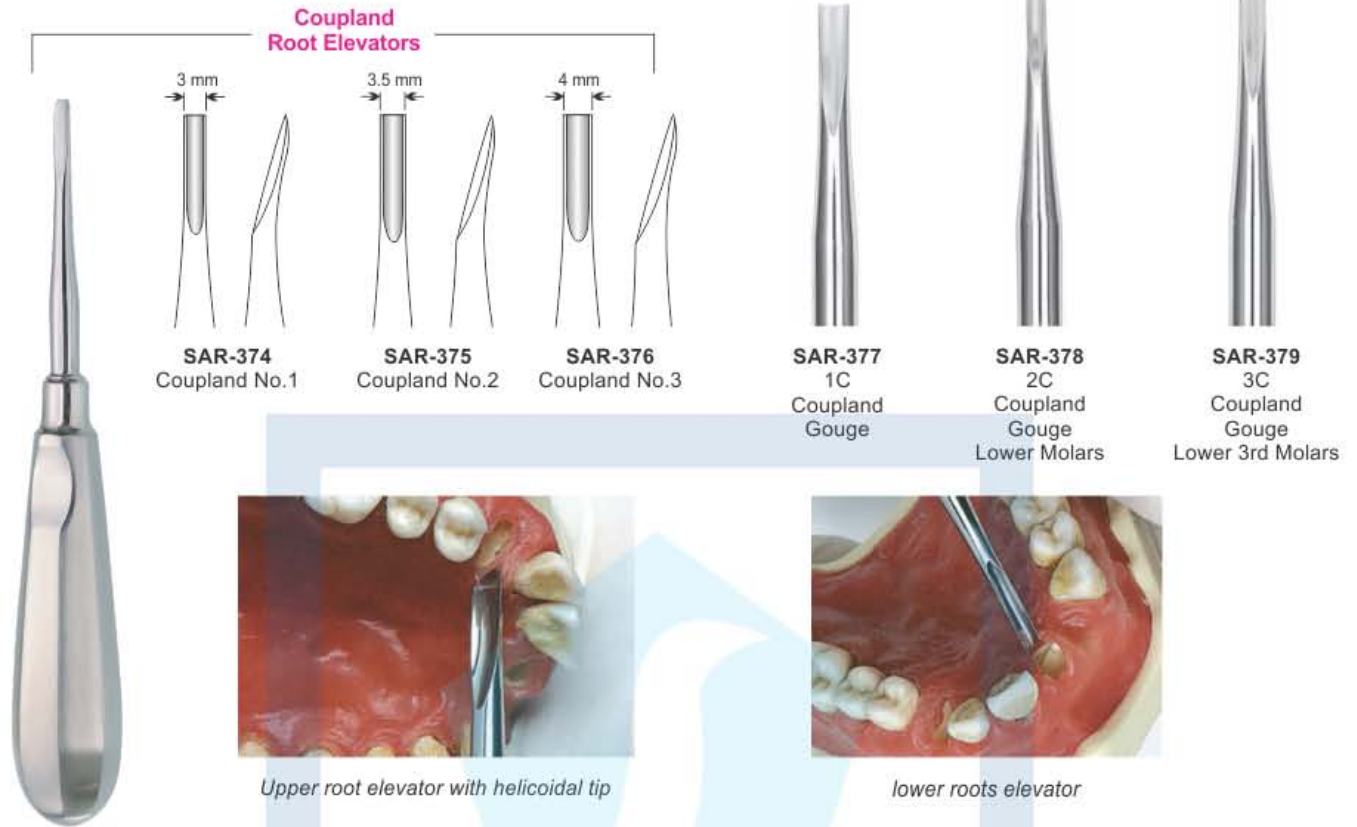

**FUNCTION:** To Loosen Tooth or Root From Bony Socket Prior to Placement of The Extraction Forceps.

## ENGLISH PATTERNS



# ROOT ELEVATOR

- Элеватор корневой экстракционный
- Elévateurs à racines
- Wurzelheber
- Слеватор корневий екстракційний
- Elevadores para raices
- المصاعد الجذر

## Friedmann Roots Elevator



**SAR-402**  
Friedmann 4F  
Str.

**SAR-403**  
Friedmann 5F  
Left

**SAR-404**  
Friedmann 6F  
Right

## Luxating Elevator With Periotome Tip

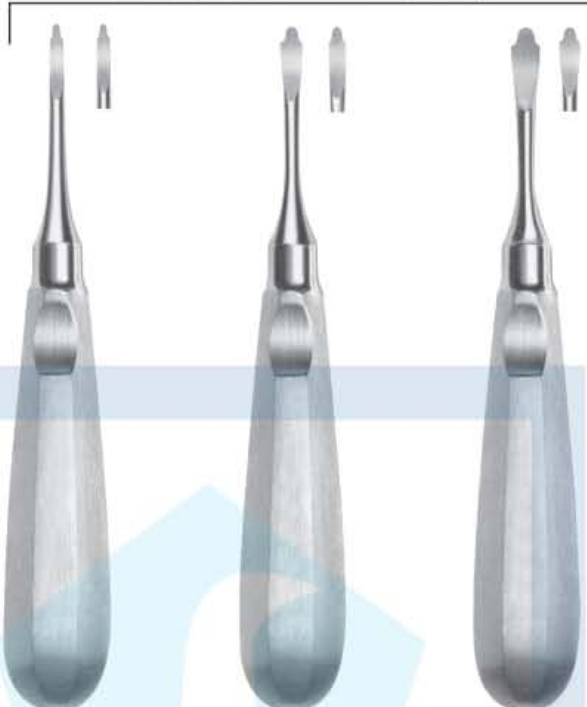

**SAR-405**  
3mm Luxating  
Elevator / Periotome

**SAR-406**  
4mm Luxating  
Elevator / Periotome

**SAR-407**  
5mm Luxating  
Elevator / Periotome

## Wisdom Roots Elevator



**SAR-408**  
Wisdom  
for 18 and 38

**SAR-409**  
Wisdom  
for 28 and 48

**Function of Root Elevators:** To loosen tooth or root from bony socket prior to placement of the extraction forceps.

## Bayonet Roots Elevator Set



**SAR-410**  
Left

**SAR-411**  
Right

**SAR-412**  
bayonet

**SAR-413**  
Curved

**SAR-414**  
Straight



# ROOT ELEVATOR

- Элеватор корневой экстракционный
- Elévateurs à racines
- Wurzelheber
- Слеватор корневий екстракційний
- Elevadores para raices
- المصاعد الجذر

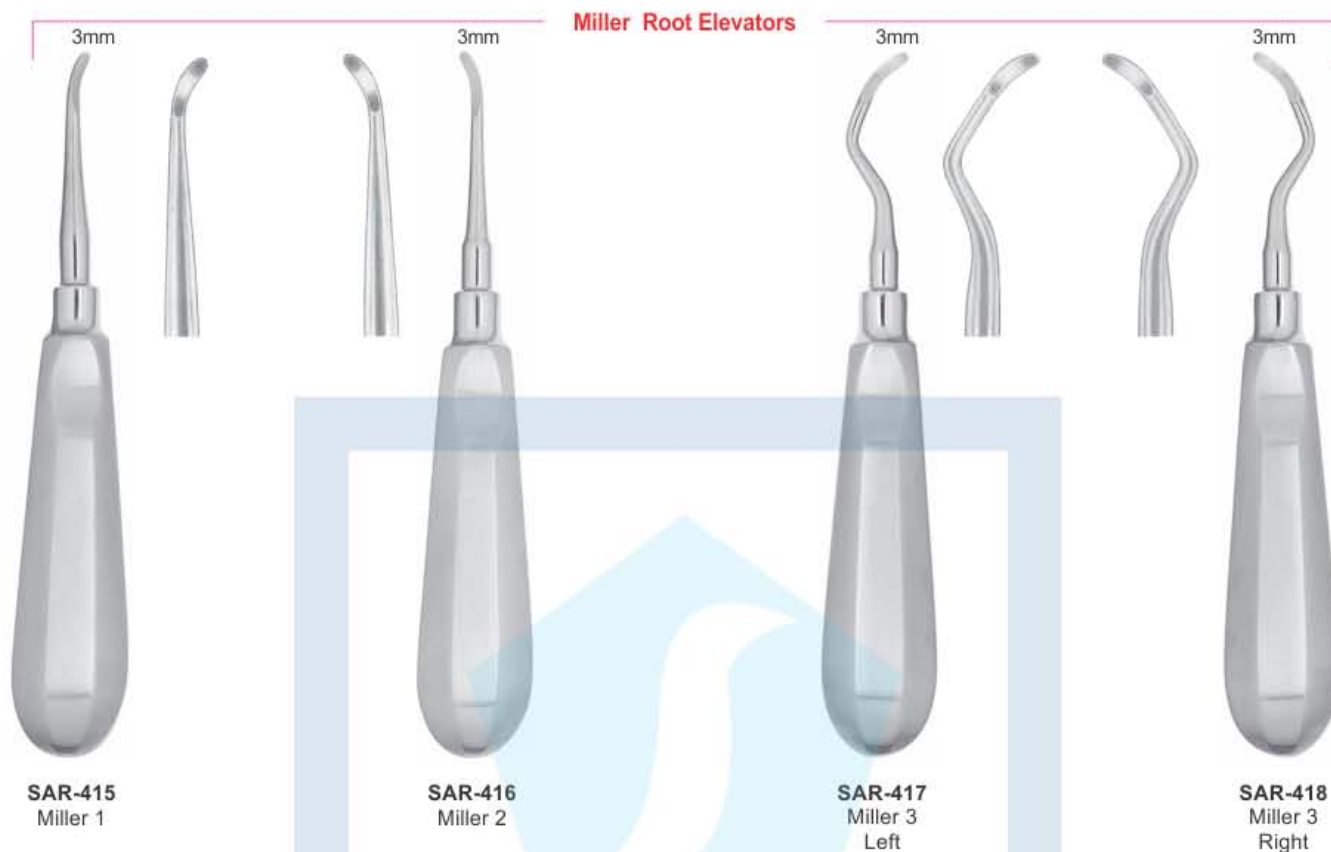

**Function of Root Elevators:** To loosen tooth or root from bony socket prior to placement of the extraction forceps.



# ROOT ELEVATOR

- Элеватор корневой экстракционный
- Elévateurs à racines
- Wurzelheber
- Слеватор корневий екстракційний
- Elevadores para raices
- المصاعد الجذر

**FUNCTION:** To Loosen Tooth or Root From Bony Socket Prior to Placement of The Extraction Forceps.

**Laxutor Root Elevators Set of 9 Pcs**



**SAR-424**  
2mm Str.



**SAR-425**  
3mm Str.



**SAR-426**  
5mm Str.



**SAR-427**  
3mm Cvd.



**SAR-428**  
5mm Cvd.



**SAR-429**  
3mm Angle



**SAR-430**  
3mm Angle



**SAR-431**  
3mm Str.



**SAR-432**  
5mm Str.



# ROOT ELEVATOR

- Элеватор корневой экстракционный
- Elévateurs à racines
- Wurzelheber
- Слеватор корневий экстракційний
- Elevadores para raices
- المصاعد الجذر

## Hylin Roots Elevator



**Function of Root Elevators:** To loosen tooth or root from bony socket prior to placement of the extraction forceps.

## Kopp Roots Elevator

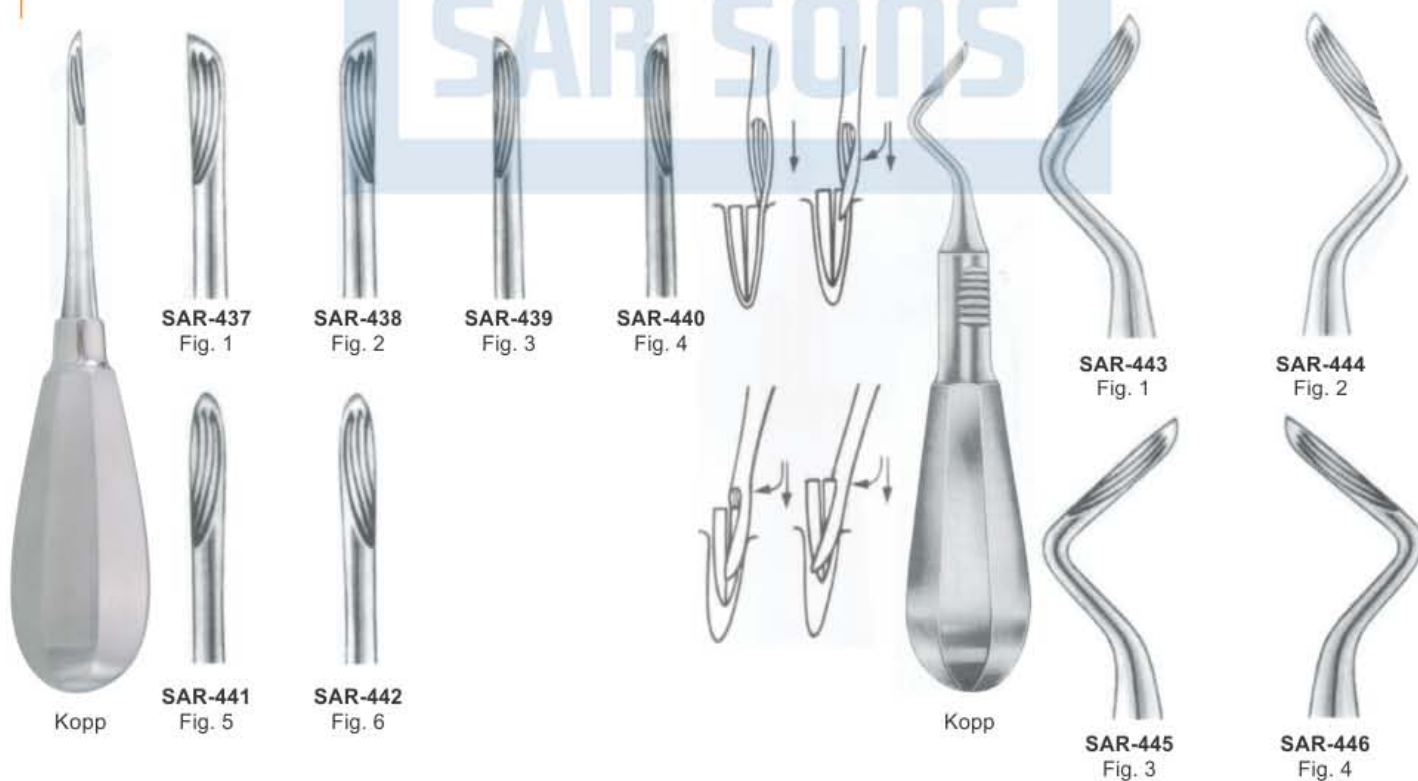

# ROOT ELEVATOR

- Элеватор корневой экстракционный
- Elévateurs à racines
- Wurzelheber
- Слеватор корневий екстракційний
- Elevadores para raíces
- المصاعد الجذر

## Luxier Roots Elevator



**SAR-447**  
Luxier  
Cvd.

**SAR-448**  
Luxier  
Str.



## Heber Roots Elevator



**SAR-449**  
Heber  
Bayonet

**SAR-450**  
Heber  
Bayonet



## Bein Roots Elevator



**SAR-451**  
Bein,  
3mm

**SAR-452**  
Bein,  
4mm

**Function of Root Elevators:** To loosen tooth or root from bony socket prior to placement of the extraction forceps.

## Bein Roots Elevator



# ROOT ELEVATOR

- Элеватор корневой экстракционный
- Elévateurs à racines
- Wurzelheber
- Слеватор корневий экстракційний
- Elevadores para raices
- المصاعد الجذر

## W. Barry Roots Elevator



**Function of Root Elevators:** To loosen tooth or root from bony socket prior to placement of the extraction forceps.



# ROOT ELEVATOR

- Элеватор корневой экстракционный
- Elévateurs à racines
- Wurzelheber
- Слеватор корневий екстракційний
- Elevadores para raices
- المصاعد الجذر



**SAR-482**  
Fig. 1  
Chompret



**SAR-483**  
Fig. 2  
Chompret



**SAR-484**  
Fig. 3  
Chompret



**SAR-485**  
Fig. 4  
Chompret



*Lecluse elevator for lower third molar dislocation*



*Chompret syndesmotome, sickle pattern*



**SAR-486**



**SAR-487**



**SAR-488**



**SAR-489**



**SAR-490**



**SAR-491**



**SAR-492**

## Root Pick Elevator With Gold Flexible Points

# ROOT ELEVATOR

- Элеватор корневой экстракционный
- Elévateurs à racines
- Wurzelheber
- Слеватор кореневий екстракційний
- Elevadores para raices
- المصاعد الجذر

## Heidbrink Roots Elevator



**SAR-493**  
Heidbrink  
Straight

**SAR-494**  
Heidbrink  
Left

**SAR-495**  
Heidbrink  
Right

**SAR-496**  
Heidbrink  
Straight

**SAR-497**  
Heidbrink  
Left

**SAR-498**  
Heidbrink  
Right

## Syndesmotomes Roots Elevator



**SAR-499**  
Straight

**SAR-500**  
Left

**SAR-501**  
Right

## Periotome Roots Elevator



**SAR-502**  
Periotome  
2.1mm  
Straight

**SAR-503**  
Periotome  
2.6mm  
Straight

**SAR-504**  
Periotome  
2.1mm  
Angular

**SAR-505**  
Periotome  
2mm  
Curved

**SAR-506**  
Periotome  
2.0mm

**SAR-507**  
Periotome  
2.5mm

**SAR-508**  
Periotome  
3.0mm

**SAR-509**  
Periotome  
4.0mm

Syndesmotomes

# ROOT ELEVATOR

- Элеватор корневой экстракционный
- Elévateurs à racines
- Wurzelheber
- Слеватор корневий екстракційний
- Elevadores para raices
- المصاعد الجذر

**FUNCTION:** To loosen small root fragments from bony socket

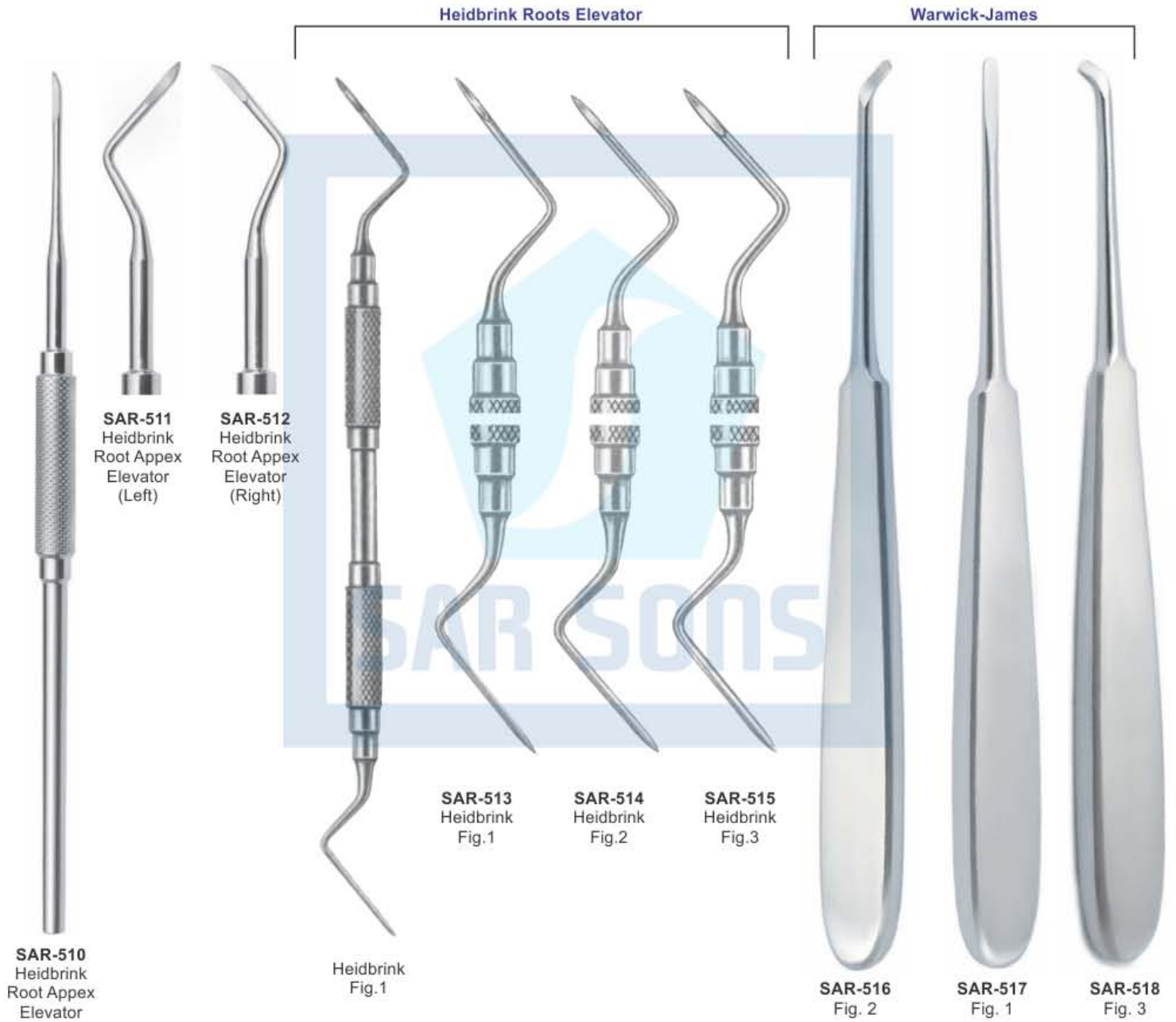



## ROOT ELEVATOR

- Элеватор корневой экстракционный
- Elévateurs à racines
- Wurzelheber
- Слеватор корневий екстракційний
- Elevadores para raices
- المصاعد الجذر



**SAR-519**  
1S  
(Straight 1mm)



**SAR-520**  
2S  
(Straight 2mm)



**SAR-521**  
3S  
(Straight 3mm)



**SAR-522**  
5S  
(Straight 5mm)



**SAR-523**  
3C  
(Curved 3mm)



**SAR-524**  
5C  
(Curved 5mm)



**SAR-525**  
3CA  
(Curved Angle 3mm)



**SAR-526**  
3IC  
(Inverted Curved 3mm)



**SAR-527**  
DE 3  
(Dual Edge 3mm / 1.5mm)



**SAR-528**  
DE 5  
(Dual Edge 5mm / 3mm)

## ROOT ELEVATOR

- Элеватор корневой экстракционный
- Elévateurs à racines
- Wurzelheber
- Єлеватор кореневий екстракційний
- Elevadores para raices
- المصاعد الجذر



**SAR-529**  
Luxators Set of 7 Pcs

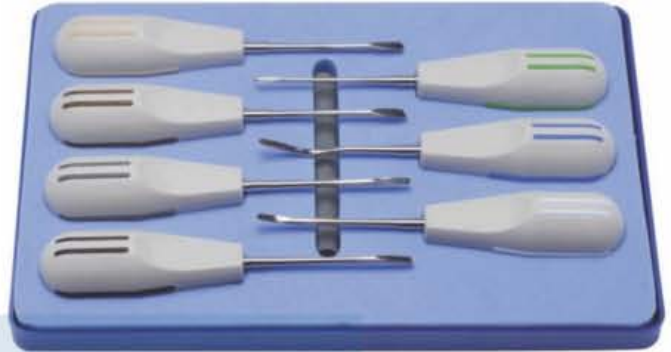

**SAR-530**  
Luxators Set of 7 Pcs



**SAR-531**  
Luxators Set of 8 Pcs



**SAR-532**  
Root Elevators Set of 10 Pcs



**SAR-533**  
Elevators Set of 8 Pcs



**SAR-534**  
Elevators Set of 8 Pcs

# ROOT ELEVATOR

- Элеватор корневой экстракционный
  - Elévateurs à racines
  - Wurzelheber
- Слеватор корневий екстракційний
  - Elevadores para raices
  - المصاعد الجذر

## PDL ELEVATORS

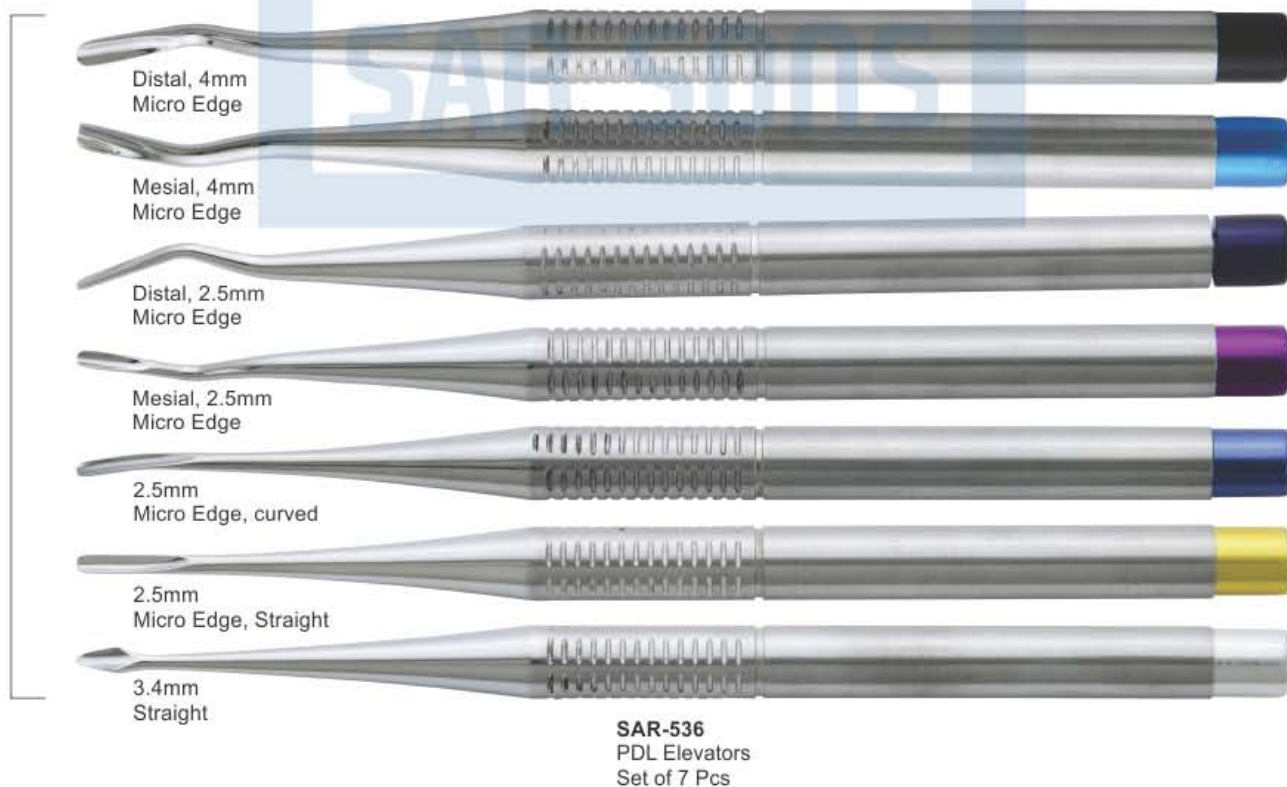
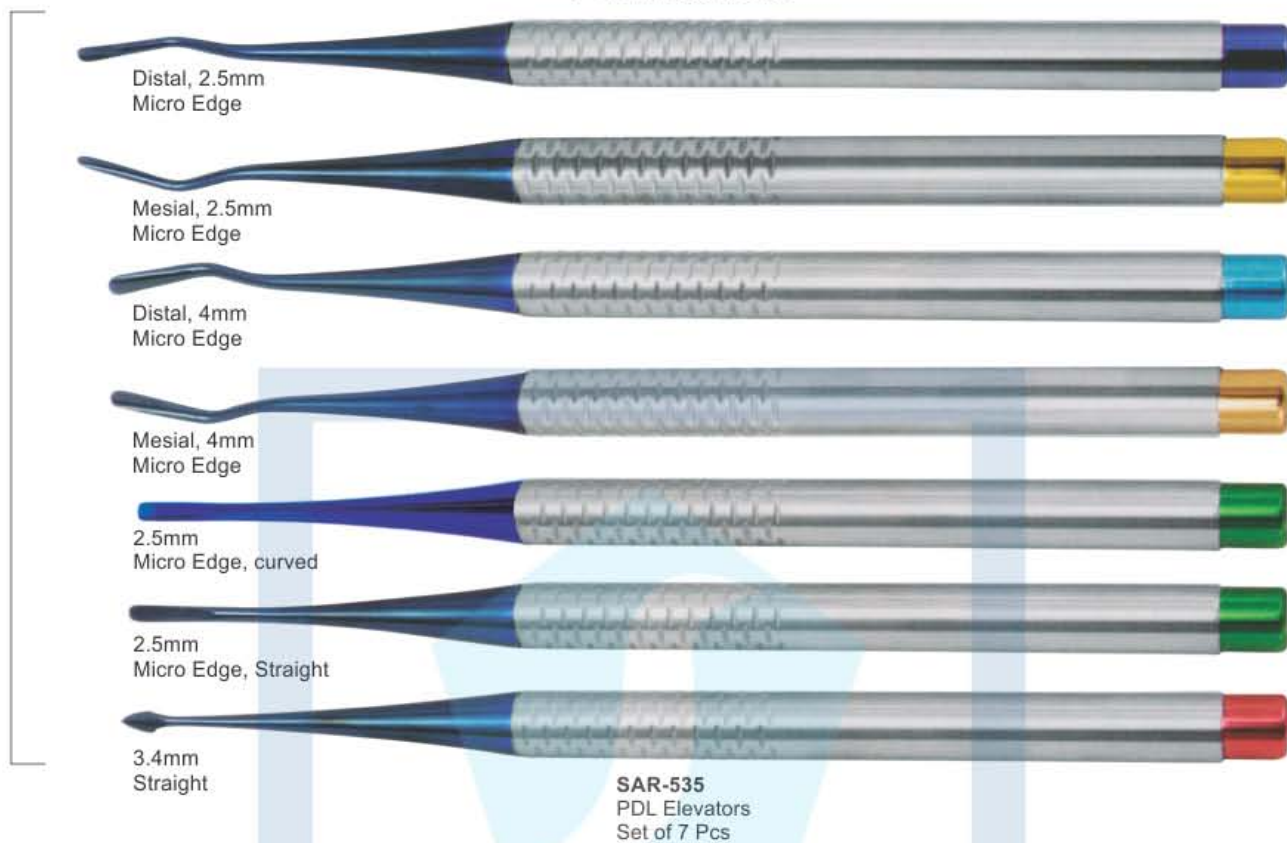

# ROOT ELEVATOR

- Элеватор корневой экстракционный
- Elévateurs à racines
- Wurzelheber
- Єлеватор кореневий екстракційний
- Elevadores para raices
- المصاعد الجذر

## PDL ELEVATORS

Delicate Arrow tip



4,0mm straight  
4,0mm curved

Luxivators straight  
atraumatic luxation of the tooth

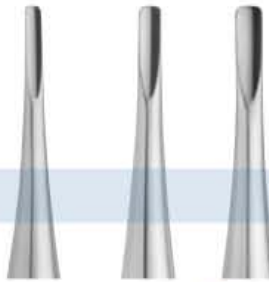

2,5mm straight  
3,5mm straight  
4,5mm straight

Luxivators curved  
atraumatic luxation of the tooth

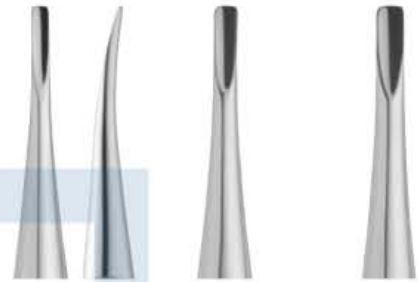

2,5mm curved  
3,5mm curved  
4,5mm curved



**SAR-537**  
PDL Elevators  
Set of 8 Pcs

## Our Scalers

Compare our scalers and curettes with the best in the industry and you will immediately recognize we are equal in every way but one... price. Note the deep precision knurling for better tactile feel. The same high-grade stainless steel tips, the same light weight (under 18 grams) for less hand fatigue, the same professional craftsmanship, and surpassing the highest industry standards. of course, any manufacturer can make these claims, but we guarantee and certify ours.

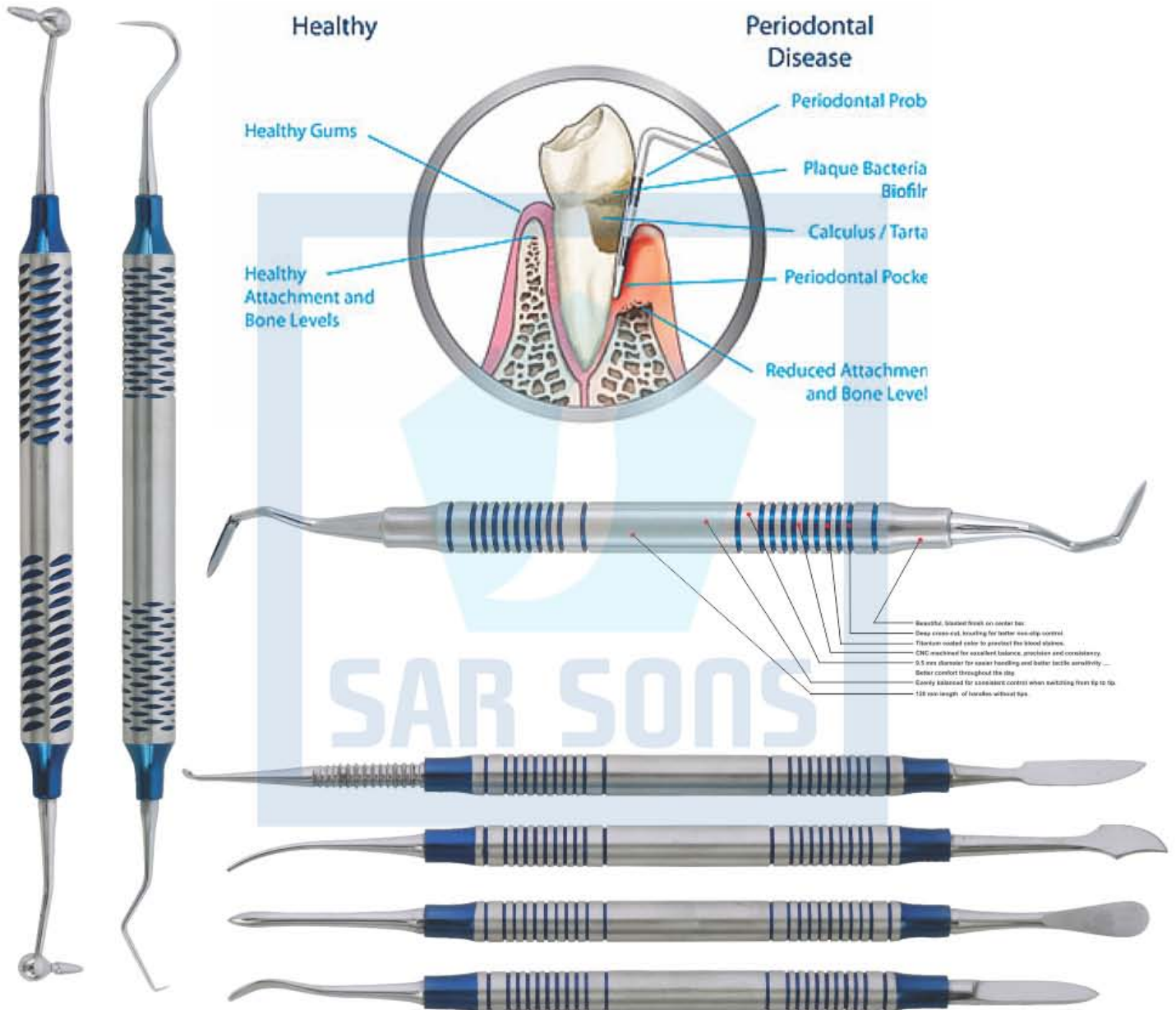

- High-polish mirror finish tips.
- Manufactured within the guidelines of the FDA quality assurance system for good manufacturing practices.
- Highest grade German stainless steel, razor sharp, durable tips. Rockwell hardened to 60 RHc.
- 27 of the most popular designs from graceys to McCalls to columbias, and many european patterns.
- All instruments are guaranteed against defects in material and workmanship.

- All instruments bear the ce mark, emblematic of the european community's highest standards.
- Customer satisfaction guarantee, too!
- Less than 20 grams ... Lightweight for less hand fatigue.
- Manufactured to the most exacting standards so the 50th instrument you buy is exactly like your first.
- You decide ... Why pay more for the same high-quality instruments?

## VALUED BUYERS

Compare our scalers and curettes with the best in the industry and you will immediately recognize we are equal in every way but one... price. Note the deep precision knurling for better tactile feel. The same high-grade stainless steel tips, the same light weight (under 20 grams) for less hand fatigue, the same professional craftsmanship, and surpassing the highest industry standards. Of course, any manufacturer can make these claims, but we guarantee and certify ours. We regularly manufacturing below articles in showing handles & pattern A to L for better grip & perfection. We are also fully equipped & capable to develop these instruments as per your own specific requirements & demands in materials, sizes, shapes and patterns.



A-Hollow Handle Ø 10 mm



B-Hollow Handle Ø 10 mm



C-Hollow Handle Ø 10 mm



D-Hollow Handle Ø 10 mm



E-Hollow Handle Ø 10 mm



F-Hollow Handle Ø 10 mm



G-Hollow Handle Ø 10 mm



H-Hollow Handle Ø 6.4 mm



I-Hollow Handle Ø 8 mm



J-Hollow Handle Ø 10 mm



K-Soild Handle Ø 6 mm



L-Soild Handle Ø 6 mm

# MOUTH MIRRORS

- зеркала
- Espejos de la boca
- Mundspiegel
- дзеркала
- Miroirs à la bouche
- مرايا الفم

## Plain



**SAR-600** Fig. 3 Ø20mm  
**SAR-601** Fig. 4 Ø22mm  
**SAR-602** Fig. 5 Ø24mm  
**SAR-603** Fig. 6 Ø26mm



## Cone-Socket Plain



**SAR-604** Fig. 3 Ø20mm  
**SAR-605** Fig. 4 Ø22mm  
**SAR-606** Fig. 5 Ø24mm

## Magnifying



**SAR-607** Fig. 3 Ø20 mm  
**SAR-608** Fig. 4 Ø22 mm  
**SAR-609** Fig. 5 Ø24 mm



## Cone-Socket Magnifying



**SAR-610** Fig. 3 Ø20mm  
**SAR-611** Fig. 4 Ø22mm  
**SAR-612** Fig. 5 Ø24mm

## Rhodium



**SAR-613** Fig. 3 Ø20mm  
**SAR-614** Fig. 4 Ø22mm  
**SAR-615** Fig. 5 Ø24 mm



## Cone-Socket Rhodium



**SAR-616** Fig. 3 Ø20mm  
**SAR-617** Fig. 4 Ø22mm  
**SAR-618** Fig. 5 Ø24mm

## Front Surface



**SAR-619** Fig. 3 Ø20mm  
**SAR-620** Fig. 4 Ø22mm  
**SAR-621** Fig. 5 Ø24mm  
**SAR-622** Fig. 6 Ø26mm



## Cone-Socket Front Surface



**SAR-623** Fig. 3 Ø20mm  
**SAR-624** Fig. 4 Ø22mm  
**SAR-625** Fig. 5 Ø24mm

## HANDLES FOR MOUTH MIRRORS

- Ручки для зеркал
- Manches pour miroirs à bouche
- Mundspiegelgriffe
- Ручки для дзеркал
- Mangos para espejos de boca
- مقابض لعرايا الفم



**SAR-626**  
Hollow Mirror  
Handle Round  
Ø 10 mm



**SAR-627**  
Hollow Mirror  
Hexagonal  
Handle  
Ø 8 mm



**SAR-628**  
Hollow  
Ø 8 mm



**SAR-629**  
Hollow Mirror  
Hexagonal  
Handle  
Ø 10 mm



**SAR-630**  
Hollow Mirror  
Handle  
Ø 8 mm



**SAR-631**  
Hollow Mirror  
Handle  
Ø 10 mm



**SAR-632**  
Mirror Handle  
Solid  
Ø 6 mm



**SAR-633**  
Mirror Handle  
Solid  
Ø 6 mm



**SAR-634**  
Mirror Handle  
Solid Octagonal  
Ø 6 mm



**SAR-635**  
Mirror Handle  
Stem  
with Rule  
35mm



**SAR-636**  
Mirror Handle  
Solid  
Stem with  
Rule 35mm



**SAR-637**  
Cone-Socket  
Solid Octagonal  
Ø 6 mm



**SAR-638**  
Cone-socket  
Solid  
Ø 6 mm



**SAR-639**  
Cone-socket  
Hexagonal  
Handle  
Ø 6 mm

Cone-Socket Mirror Handle



# EXPLORERS

- Зонды
  - Sondes
  - Zahnsonden
- Зонди
  - Sondas
  - المستكشفين

Examination kit Set of 3 Pieces



**SAR-640** Probe  
**SAR-641** Mirror  
**SAR-642** College Forcep  
 15cm



Examination Set of 4 Pieces



**SAR-643** Exp,23/17-A  
**SAR-644** Exavators  
**SAR-645** Tweezers  
**SAR-646** Mouth Mirror

**SAR-647**

First Aid Examination Set of 3 Pieces



**SAR-648**

First Aid Examination Set of 3 Pieces



**SAR-649**

First Aid Examination Set of 3 Pieces



**SAR-650**

First Aid Examination Set of 3 Pieces



## TWEEZERS

- Пинцеты
- Précelles - Brucelles
- Zahnpinzetten
- Пинцети
- Pinzas para algodón
- ملاقط



**SAR-651**  
Surgical  
11.5cm



**SAR-652**  
London College  
15cm



**SAR-653**  
Semken Taylor  
Str.



**SAR-654**  
Semken Taylor  
Cvd.



**SAR-655**  
Meriam  
16cm



**SAR-656**  
Dressing  
14cm



**SAR-657**  
Semken Taylor  
1x2 Straight



**SAR-658**  
Semken Taylor  
1x2 Curved



**SAR-659**  
Gilles  
15cm 1x2



**SAR-660**  
14cm 1x2



**SAR-661**  
Perry  
13cm



**SAR-662**  
Atraumatic  
15cm Cvd



**SAR-663**  
Atraumatic  
15cm Str.



**SAR-664**  
College with Lock  
15cm Cvd.



**SAR-665**  
Gerald  
17.5cm



**SAR-666**  
with lock  
15cm



**SAR-667**  
Atraumatic  
17.5cm

# TWEEZERS

- Пинцеты
- Précelles - Brucelles
- Zahnpinzetten

- Пинцети
- Pinzas para algodón
- ملاقط



**SAR-668**  
Adson-TC  
12cm



**SAR-669**  
Adson-TC  
12cm 1x2



**SAR-670**  
Adson-TC  
15cm 1x2



**SAR-671**  
Adson  
12cm



**SAR-672**  
Adson  
12cm 1x2



**SAR-673**  
Adson  
15cm 1x2



**SAR-674**  
Adson Brown  
12cm



**SAR-675**  
Crane Kaplan  
15cm



**SAR-676**  
Crane Kaplan  
15cm



**SAR-677**  
Crane Kaplan  
15cm



**SAR-678**  
Hemingway  
15cm



**SAR-679**  
Miller  
15cm Str.



**SAR-680**  
Miller  
15cm Cvd.



**SAR-681**  
Dressing  
Tweezer  
14.5cm



**SAR-682**  
College  
Curved  
Tip 15cm



**SAR-683**  
Maryam  
Tweezers  
15cm



**SAR-684**  
College  
Tweezer  
15cm



**SAR-685**  
Perry  
Tweezer  
12.5cm



**SAR-686**  
Self-locking  
Tweezer  
15cm

# EXPLORERS

- Зонды
- Sondes
- Zahnsonden
- Зонди
- Sondas
- المستكشفين

Single Ended Probe Solid Handle 4.5mm Length 150mm

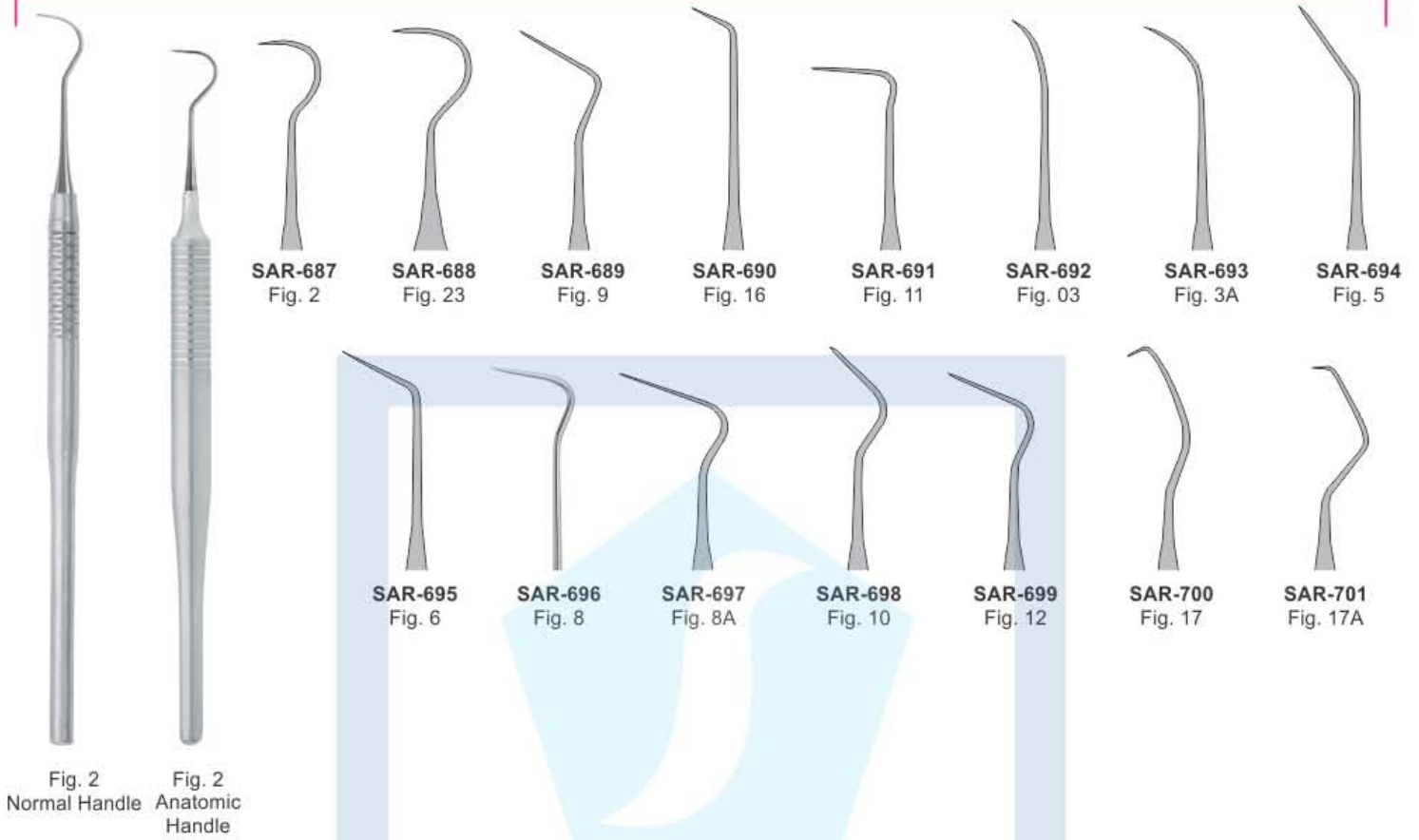

Explorers-Single-End

Double-Ended Explorers

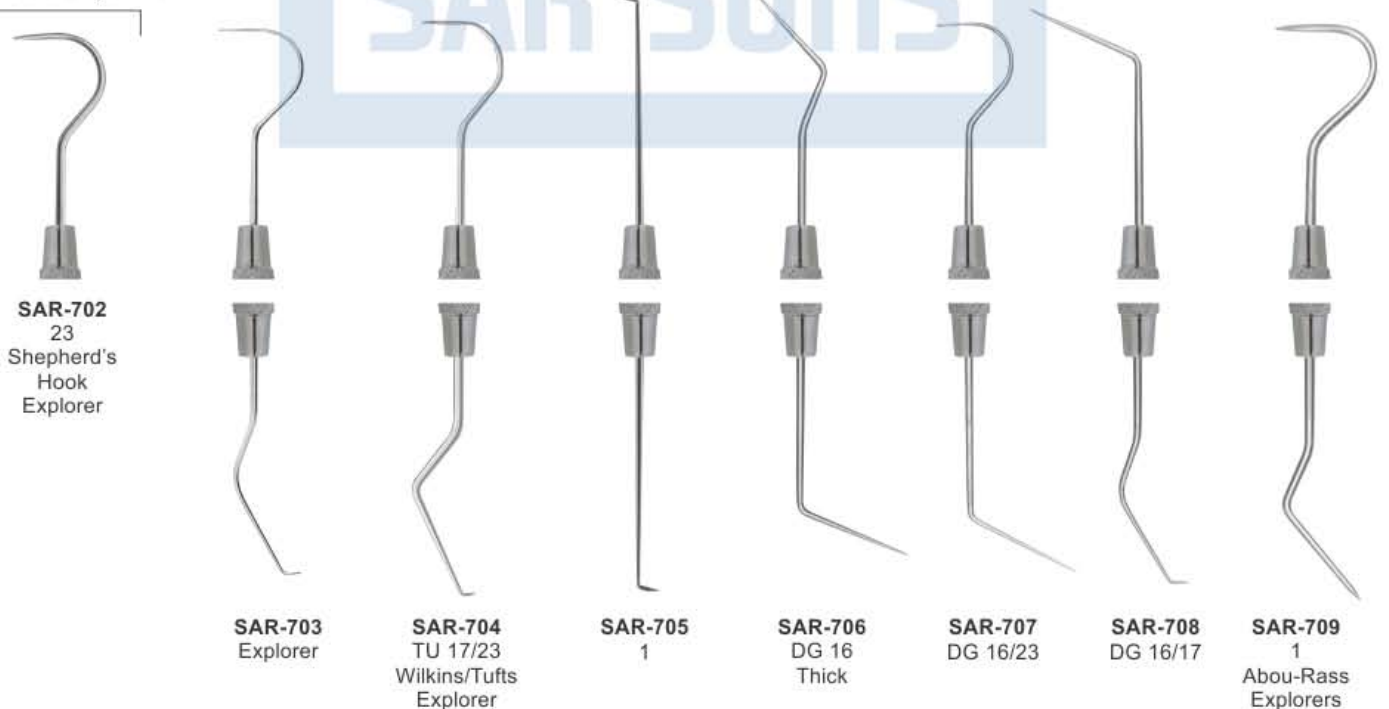

# EXPLORERS

- Зонды
  - Sondes
  - Zahnsonden
- Зонди
  - Sondas
  - المستكشفين

Probes Double Ended 6mm, length 170mm

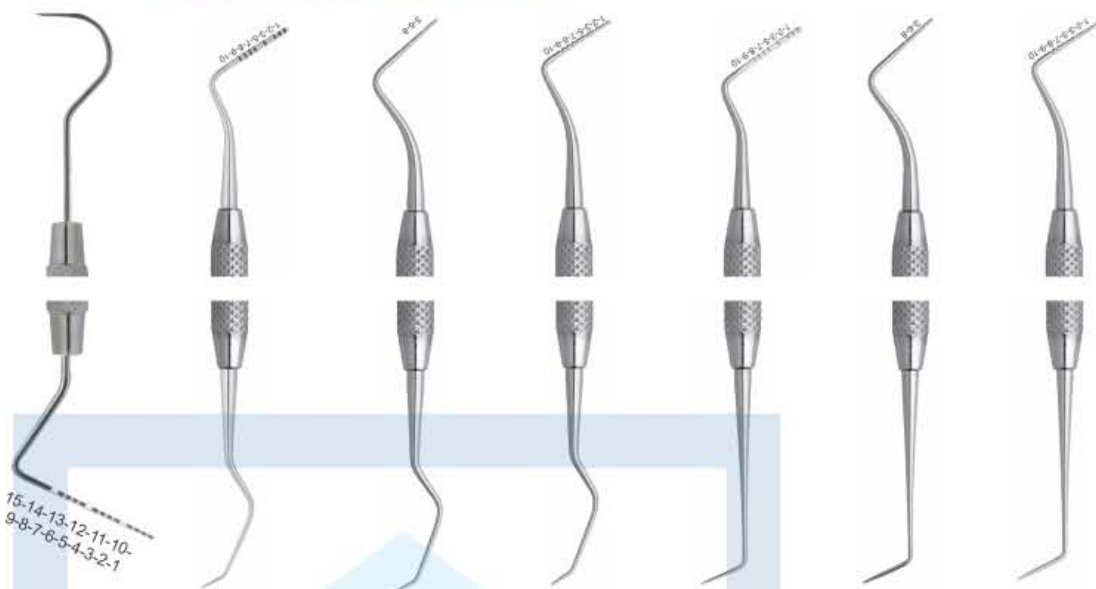

**SAR-711**  
23/UNC1  
university of north carolina Explorer

**SAR-712**  
Goldman Fox  
Fig.17

**SAR-713**  
University of Michigan  
Fig.17

**SAR-714**  
Williams  
Fig.17

**SAR-715**  
Goldman Fox  
Fig.16

**SAR-716**  
University of Michigan  
Fig.16

**SAR-717**  
Williams  
Fig.16

Pointed Probes Double Ended Handle 6mm, length 170mm

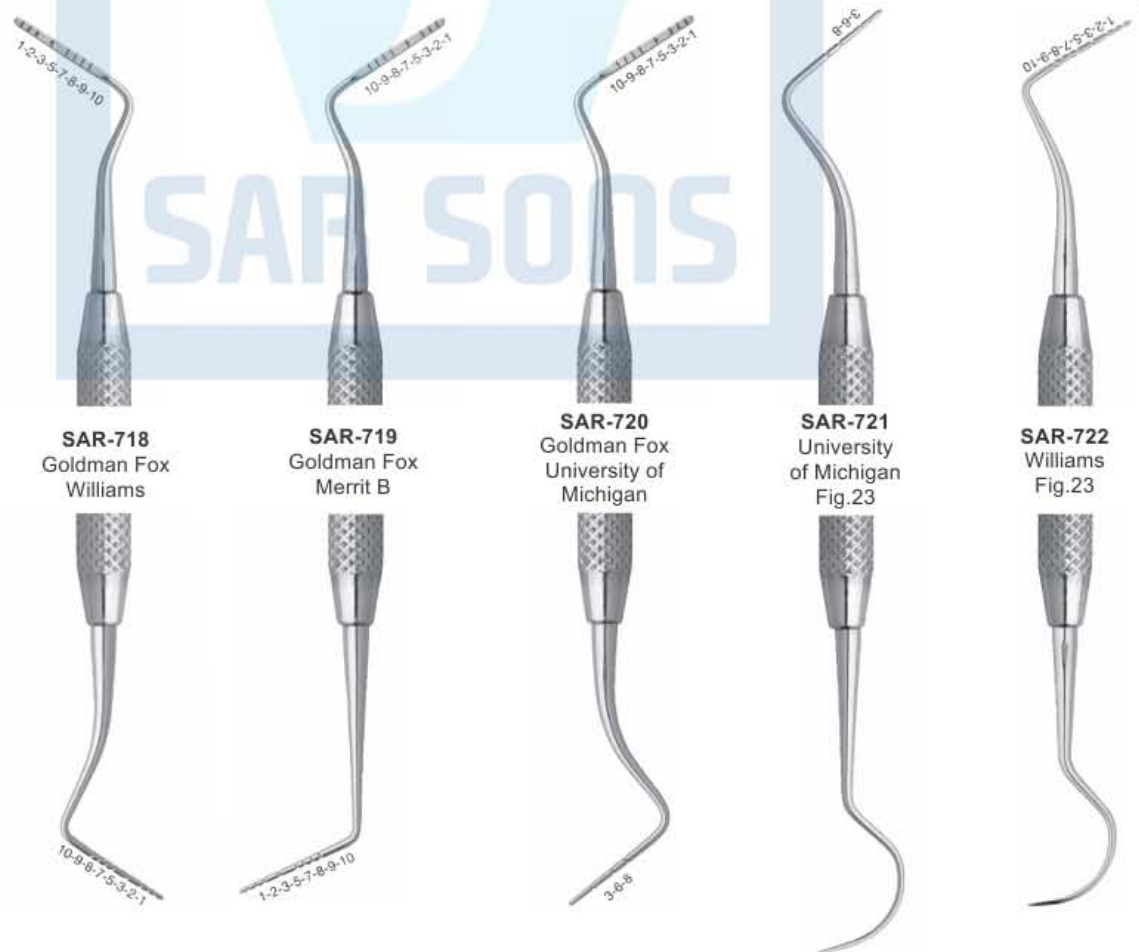

**SAR-718**  
Goldman Fox  
Williams

**SAR-719**  
Goldman Fox  
Merrit B

**SAR-720**  
Goldman Fox  
University of Michigan

**SAR-721**  
University of Michigan  
Fig.23

**SAR-722**  
Williams  
Fig.23



**SAR-710**  
Williams

# EXPLORERS

- Зонды
  - Sondes
  - Zahnsonden
- Зонди
  - Sondas
  - المستكشفين

EXPLORERS INSTRUMENTS SOLID HANDLE 6MM, LENGTH 170MM

## PLUGGERS

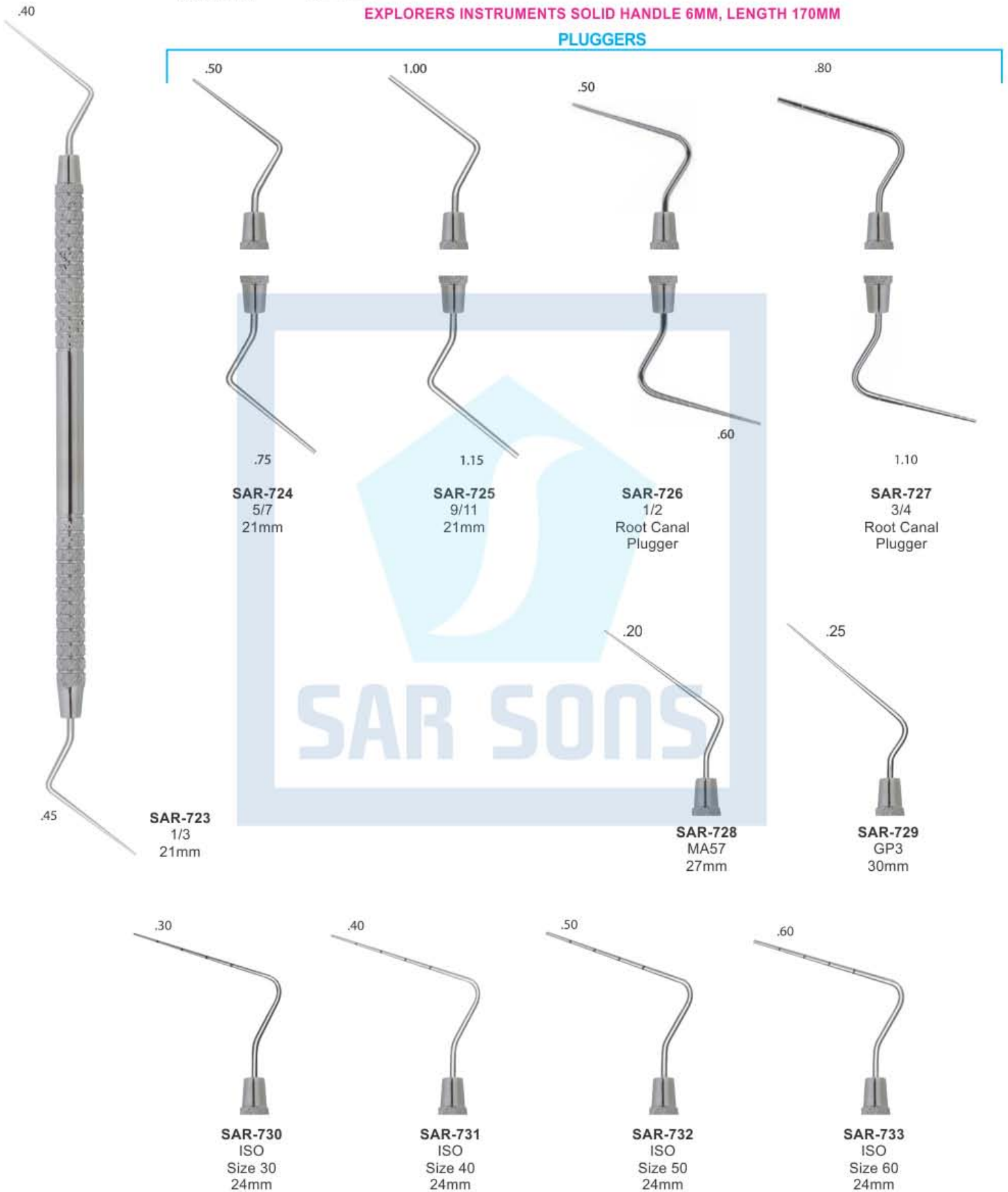

# PERIODONTAL PROBES



- Зонды пародонтологические
- Sondes paradontales
- sonde parodontali
- зонди пародонтологічні
- Sondas paradontales
- المسابير اللثة

## SPREADERS

## HEAT CARRIERS

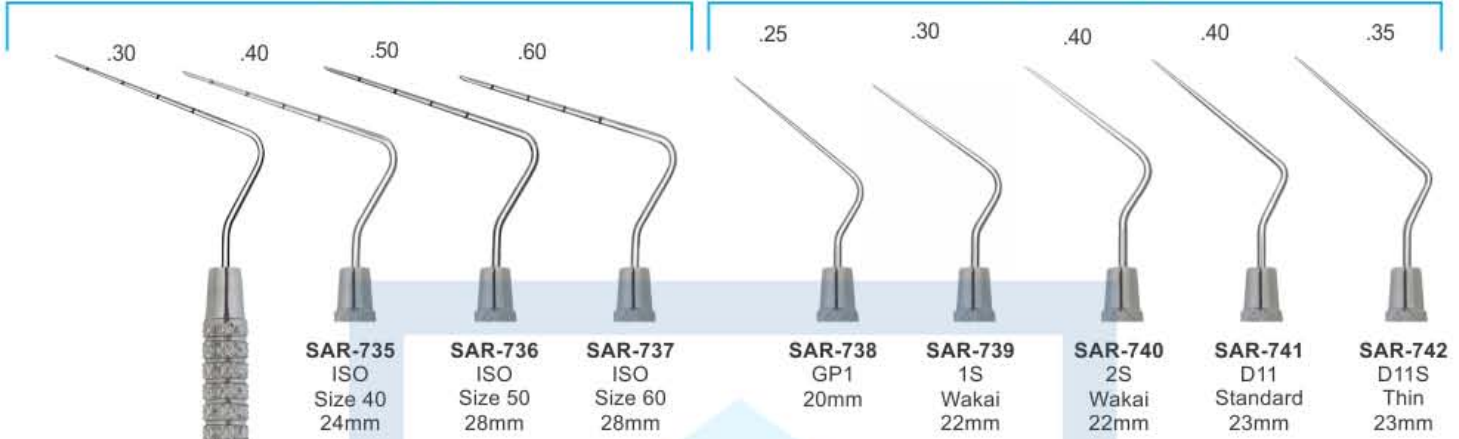

## HEAT CARRIERS

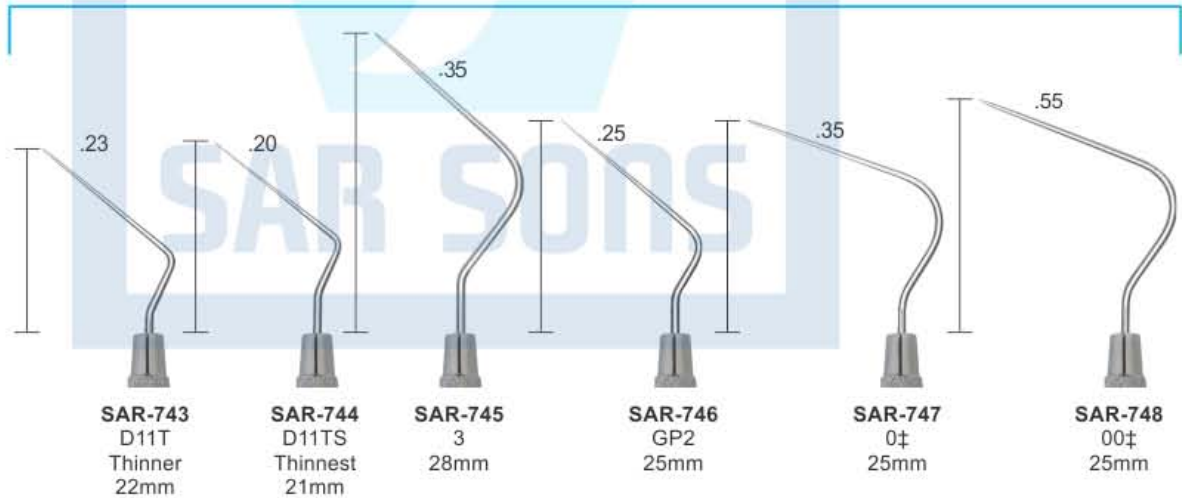

**SAR-734**  
ISO  
Size 30  
24mm

# PERIODONTAL PROBES

- Зонды пародонтологические
- Sondes parodontales
- sonda parodontali
- зонди пародонтологічні
- Sondas parodontales
- المسابر اللثة

## ENDODONTICS INSTRUMENTS

### ANTERIOR

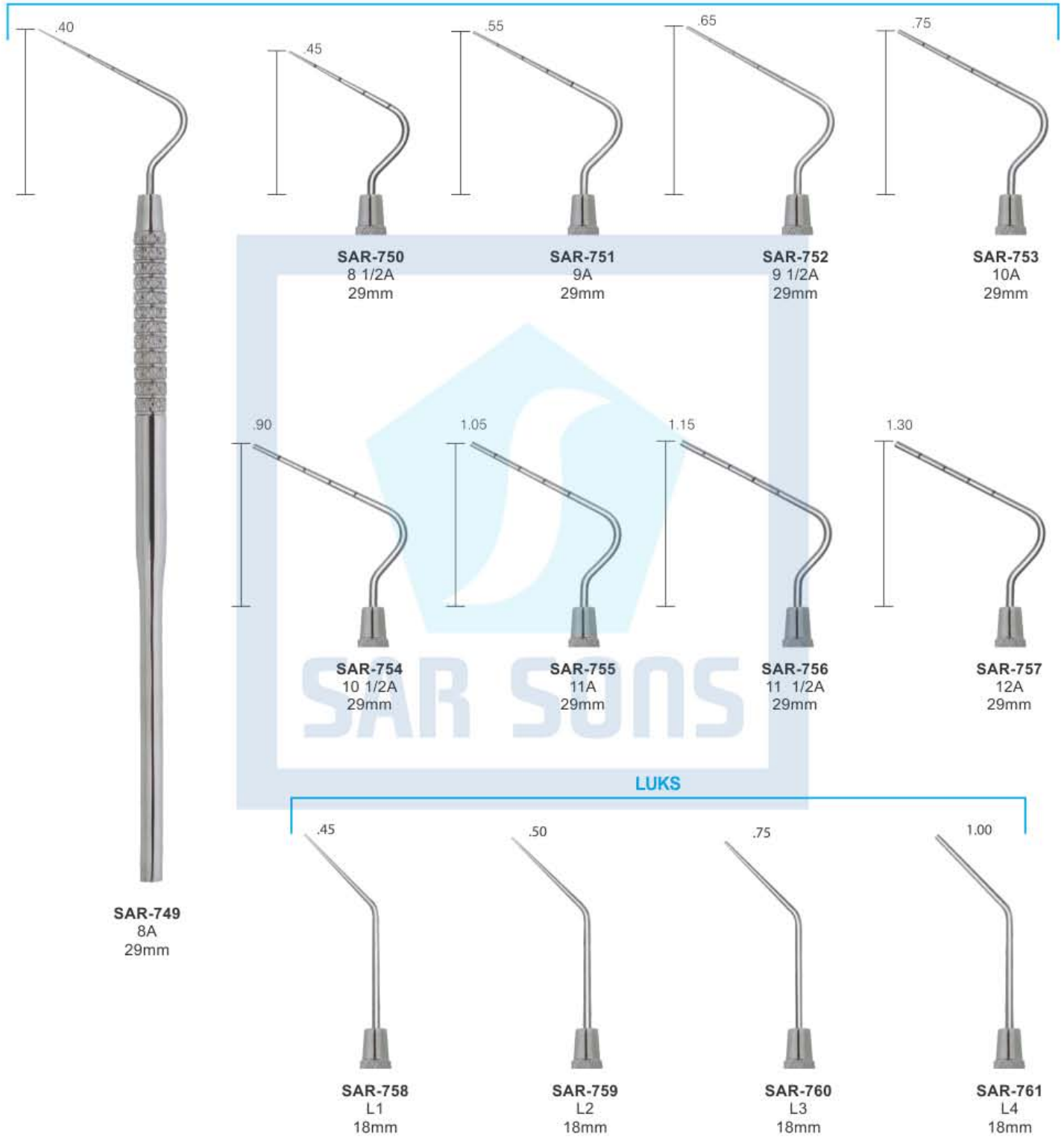





**SAR-762**  
Gracey Curettes 1/2



**SAR-763**  
Gracey Curettes 3/4



**SAR-764**  
Gracey Curettes 5/6



**SAR-765**  
Gracey Curettes 7/8



**SAR-766**  
Gracey Curettes 9/10



**SAR-767**  
Gracey Curettes 11/12



**SAR-768**  
Gracey Curettes 13/14



**SAR-769**  
Gracey Curettes 1/2



**SAR-770**  
Gracey Curettes 3/4



**SAR-771**  
Gracey Curettes 5/6



**SAR-772**  
Gracey Curettes 7/8



**SAR-773**  
Gracey Curettes 9/10



**SAR-774**  
Gracey Curettes 11/12



**SAR-775**  
Gracey Curettes 13/14



## GRACEY MINI FIVE

Hollow Handle 9.5mm, Length 170mm Ceramic Coated Handle



**SAR-777**  
Fig. 3/4 Gracey 3M



**SAR-778**  
Fig. 5/6 Gracey 3M



**SAR-779**  
Fig. 7/8 Gracey 3M  
Buccal and lingual/  
Palatal surfaces



**SAR-780**  
Fig. 11/12 Gracey 3M  
Mesial



**SAR-781**  
Fig. 13/14 Gracey 3M  
Distal

## GRACEY AFTER FIVE

Hollow Handle 9.5mm, Length 170mm Ceramic Coated Handle



**SAR-783**  
Gracey 3/4 AF



**SAR-784**  
Gracey 5/6 AF



**SAR-785**  
Gracey 7/8 AF



**SAR-786**  
Gracey 11/12 AF



**SAR-787**  
Gracey 13/14 AF

**SAR-776**  
Fig. 1/2  
Gracey 3m



**SAR-782**  
Gracey  
1/2 AF



## Gracey Curettes



3...1	1...3	<b>SAR-788</b> Fig. 1/2 GR - Gracey Buccal surfaces
3...1	1...3	



5...1	1...5	<b>SAR-789</b> Fig. 3/4 GR - Gracey Lingual/Palatal surfaces
5...1	1...5	



5...1	1...5	<b>SAR-790</b> Fig. 5/6 GR - Gracey
5...1	1...5	



8...4	4...8	<b>SAR-791</b> Fig. 7/8 GR - Gracey Buccal and lingual/ palatal surfaces
8...4	4...8	



8...4	4...8	<b>SAR-792</b> Fig. 9/10 GR - Gracey Buccal and lingual/ palatal surfaces more angled
8...4	4...8	



8...4	4...8	<b>SAR-793</b> Fig. 11/12 GR - Gracey Mesial
8...4	4...8	



8...4	4...8	<b>SAR-794</b> Fig. 13/14 GR - Gracey Distal
8...4	4...8	



8...4	4...8	<b>SAR-795</b> Fig. 15/16 GR - Gracey Mesial
8...4	4...8	



8...4	4...8	<b>SAR-796</b> Fig. 17/18 GR - Gracey Distal
8...4	4...8	



- # 1/2 - # 3/4 - # 5/6
- # 7/8 - # 9/10
- # 11/12 - # 15/16
- # 17/18 - # 17/18

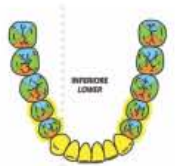
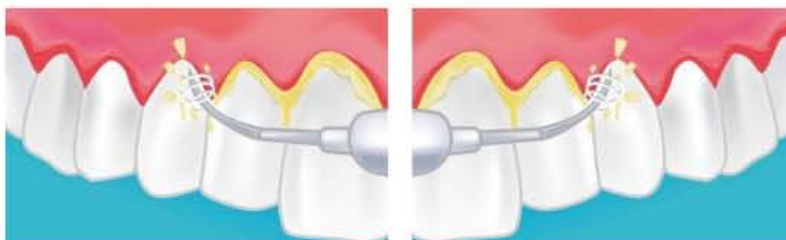

- # 1/2 - # 3/4 - # 5/6
- # 7/8 - # 9/10
- # 11/12 - # 15/16
- # 17/18 - # 17/18

# SCALER

## Sickle Scalars



SAR-797 Fig. U15/33 - Towner-Jaquette



SAR-798 Fig. U15/30 - Towner-Jaquette



SAR-799 Fig. H5/33



SAR-800 Fig. H6/H7



SAR-801 Fig. 30/33 - Jaquette



SAR-802 Fig. T2/T3 - Taylor



SAR-803 Fig. 204



SAR-804 Fig. 204S



SAR-805 Fig. 11/12 - MC - McCall  
Mesial



SAR-806 Fig. 13/14 - MC - McCall  
Distal

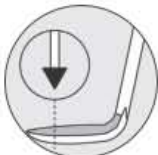

**Straight and curved sickle scalars**  
Feature: 2 cutting edges curved facial component tipped ends



**Universal curettes**  
are characterized by an angle of 90° between the terminal stem and the cutting component.

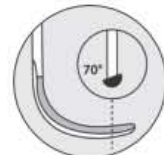
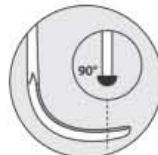

**Gracey curettes**  
are characterized by an angle of 70° between the terminal stem and the cutting component.

Universal Curettes



SAR-807 Fig. 13S/14S - MC - McCall



SAR-808 Fig. 17S/18S - MC - McCall Distal



SAR-809 Fig. M23



SAR-810 Fig. 204SD



SAR-811 Fig. YG7/8-Younger Good



SAR-812 Fig. L 1/2 - Langer



SAR-813 Fig. L 3/4 - Langer



SAR-814 Fig. L 5/6 - Langer



SAR-815 Fig. M 23A



SAR-816 Fig. M 23B

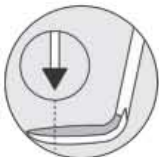

**Straight and curved sickle scalers**  
Feature: 2 cutting edges curved facial component tipped ends



**Universal curettes**  
are characterized by an angle of 90° between the terminal stem and the cutting component.

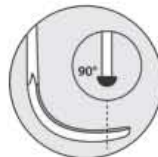

**Gracey curettes**  
are characterized by an angle of 70° between the terminal stem and the cutting component.

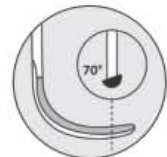

**Periodontal knives**





0.9 mm



0.7 mm



Chisels  
Diamond coated margin trimmers

Thanks to the diamond-coated hand instruments the margins are evenly levelled.

## Margin trimmers



**SAR-835**  
1TH2 Hirt



**SAR-836**  
5TH6 Hirt



**SAR-837**  
3TH4 Hirt



**SAR-838**  
7TH8 Hirt



**SAR-839**  
62NS61

2.0 MM

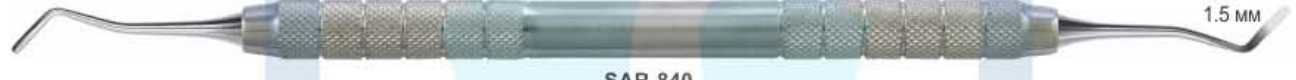

**SAR-840**  
37NS36

1.5 MM



**SAR-841**  
66NS65

1.0 MM

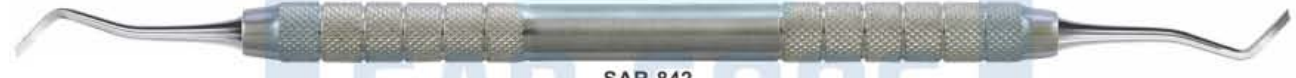

**SAR-842**  
79CI80 Black

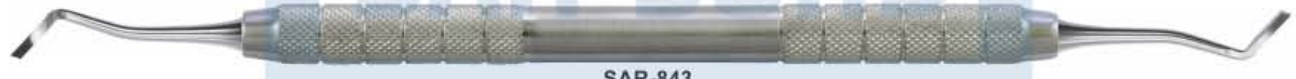

**SAR-843**  
77CI78 Black



**SAR-844**  
279CI280 Black



**SAR-845**  
277CI278 Black



**SAR-846**  
179CI180 Black



**SAR-847**  
177CI178 Black



CHISELS



**SAR-848**  
1/2 Werdelstaedt



**SAR-849**  
3/4 Werdelstaedt



**SAR-850**  
7 Straight



**SAR-851**  
5/6 Straight



**SAR-852**  
7/10 Straight



**SAR-853**  
8/9 Binangle



**SAR-854**  
11/12 Binangle



**SAR-855**  
40/41 Binangle

Tartar Remover Instruments Solid Handle Ø 6 mm



**SAR-856**  
Fig. 1



**SAR-857**  
Fig. 1L  
Left



**SAR-858**  
Fig. 1R  
Right



**SAR-859**  
Fig. 2L  
left



**SAR-860**  
Fig. 2R  
Right



**SAR-861**



**SAR-862**



**SAR-863**

# BURNISHERS CONSERVATIVE TREATMENT





SAR-876



SAR-877



SAR-878



SAR-879



SAR-880



SAR-881



SAR-882



SAR-883



SAR-884



SAR-885  
PLANATOR



SAR-886  
PLANATOR

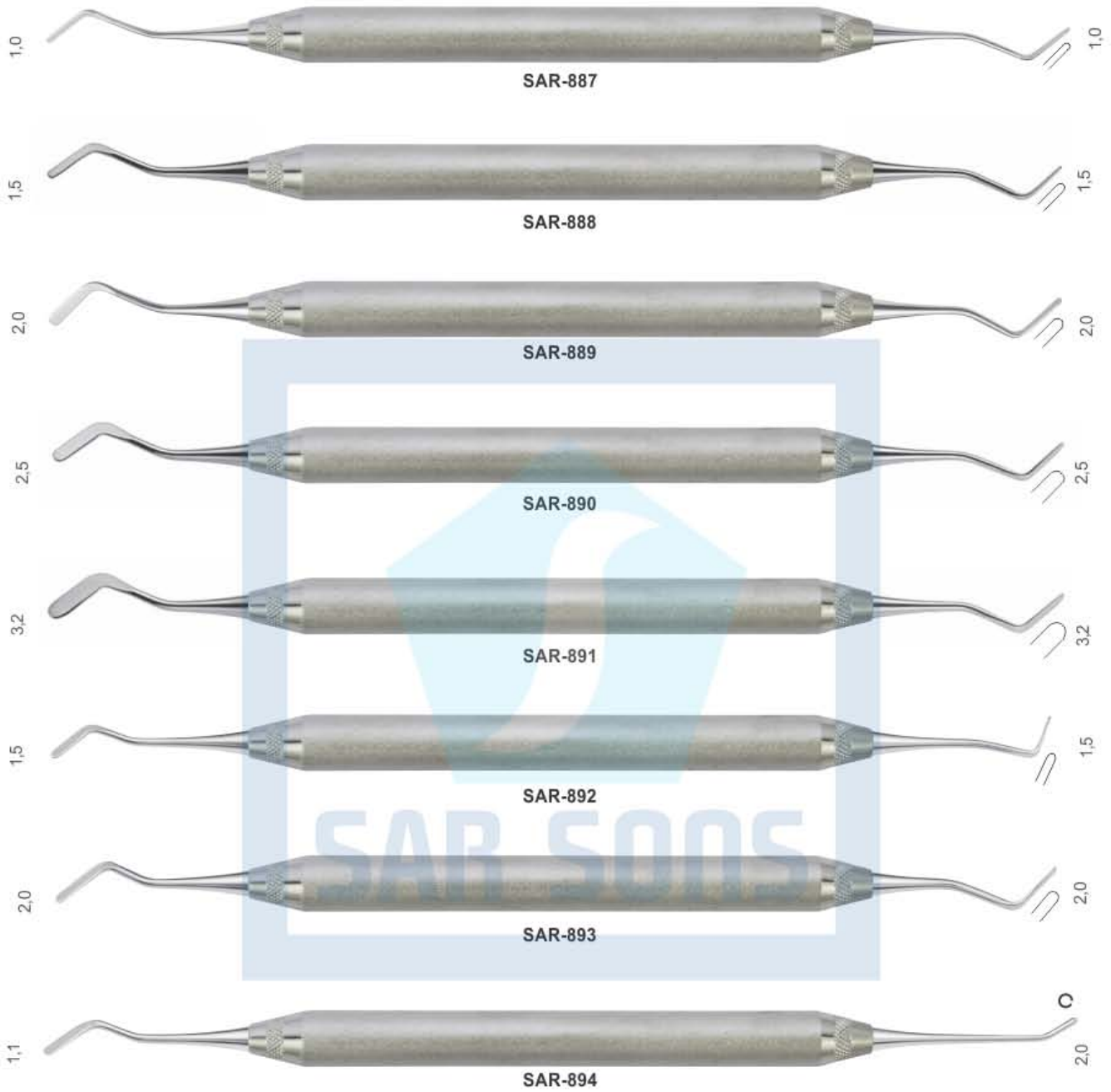

Ball Burnishers



SAR-895



SAR-896



SAR-897



SAR-898



Hatches



SAR-899



SAR-900



SAR-901  
Mini-Spatel



SAR-902  
Mini-Spatel

# COMPOSITE INSTRUMENTS

Spatulas rounded and sharp

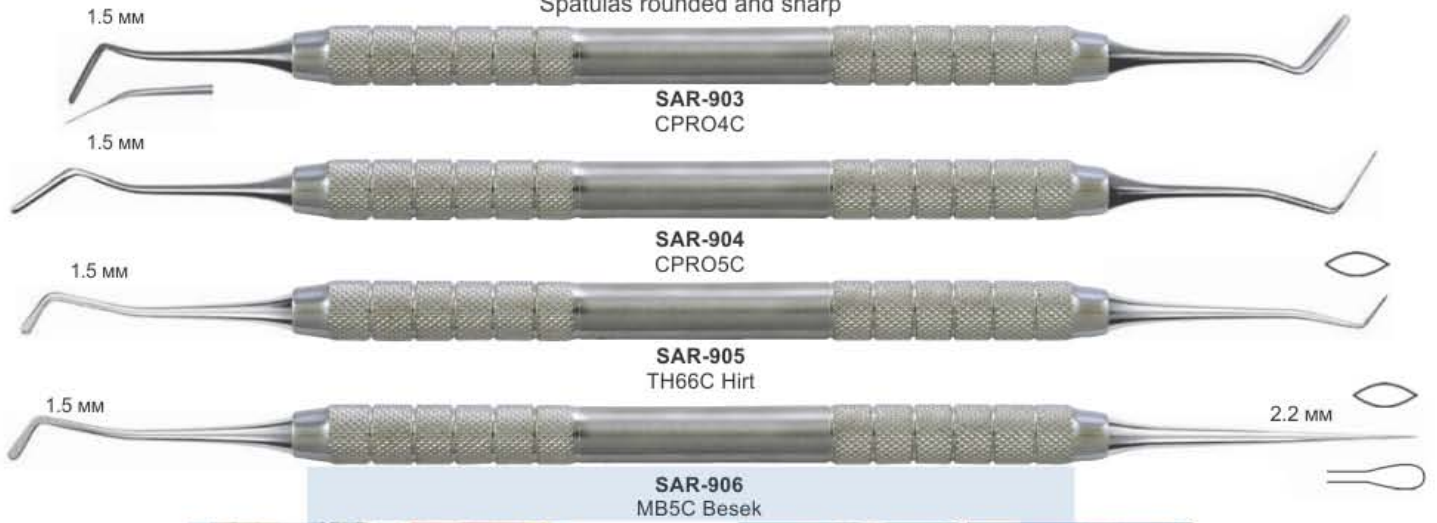

**Spatulas Blade Thickness 0.22 mm**



## Spatulas



## Spatulas-Pluggers



## EXCAVATOR INSTRUMENTS

Water drop Our excavators have particularly sharp blades, free of burrs and perfectly rounded.



**SAR-929**  
0.8 MM



**SAR-930**  
0.8 MM



**SAR-931**  
0.8 MM



**SAR-932**  
1.1 MM



**SAR-933**  
1.1 MM



**SAR-934**  
1.2 MM



**SAR-935**  
1.2 MM



**SAR-936**  
1.4 MM



**SAR-937**  
1.6 MM



**SAR-938**  
1.9 MM







# COMPOSITE BALL PLUGGERS

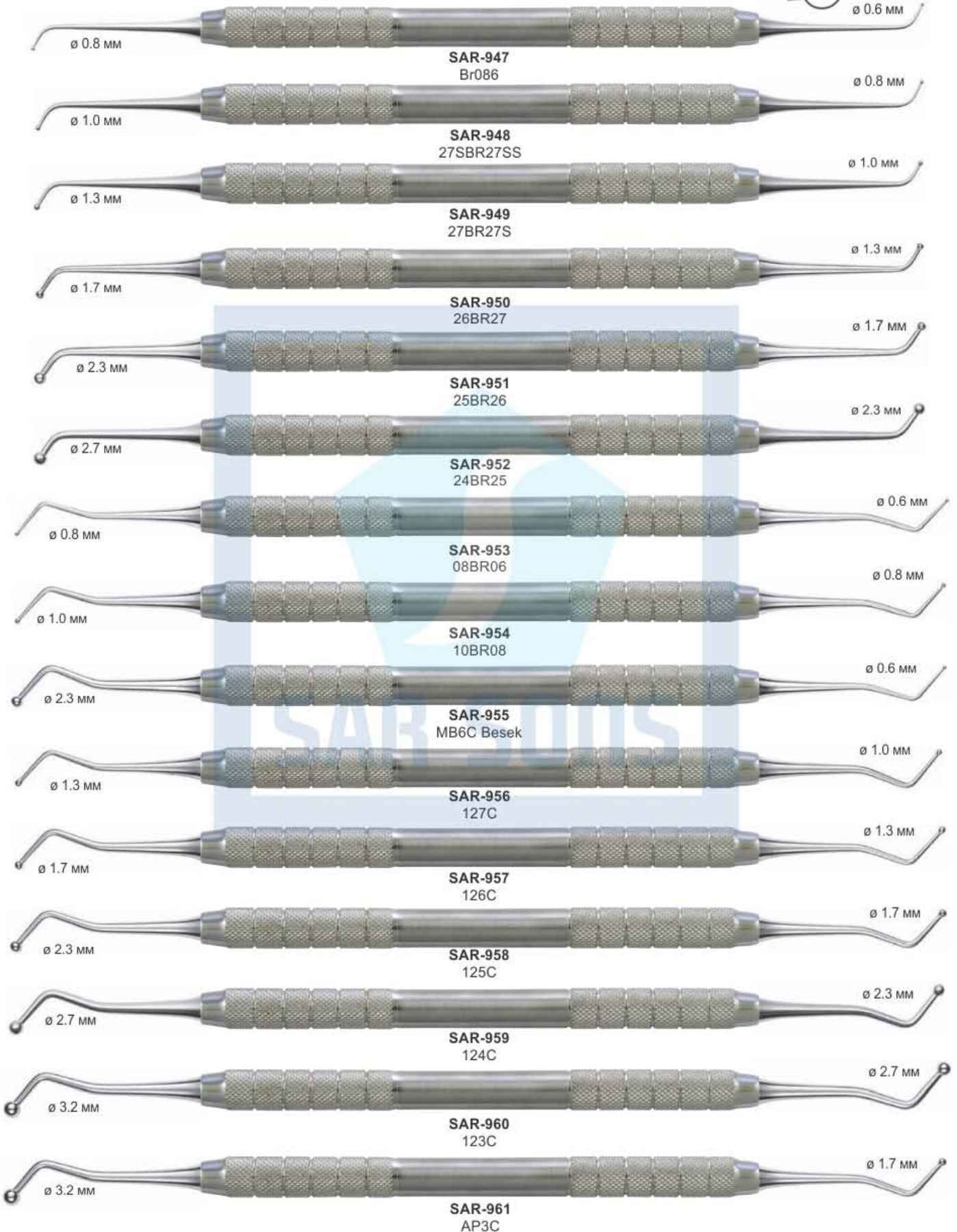

# FILLING INSTRUMENTS CONSERVATIVE TREATMENT

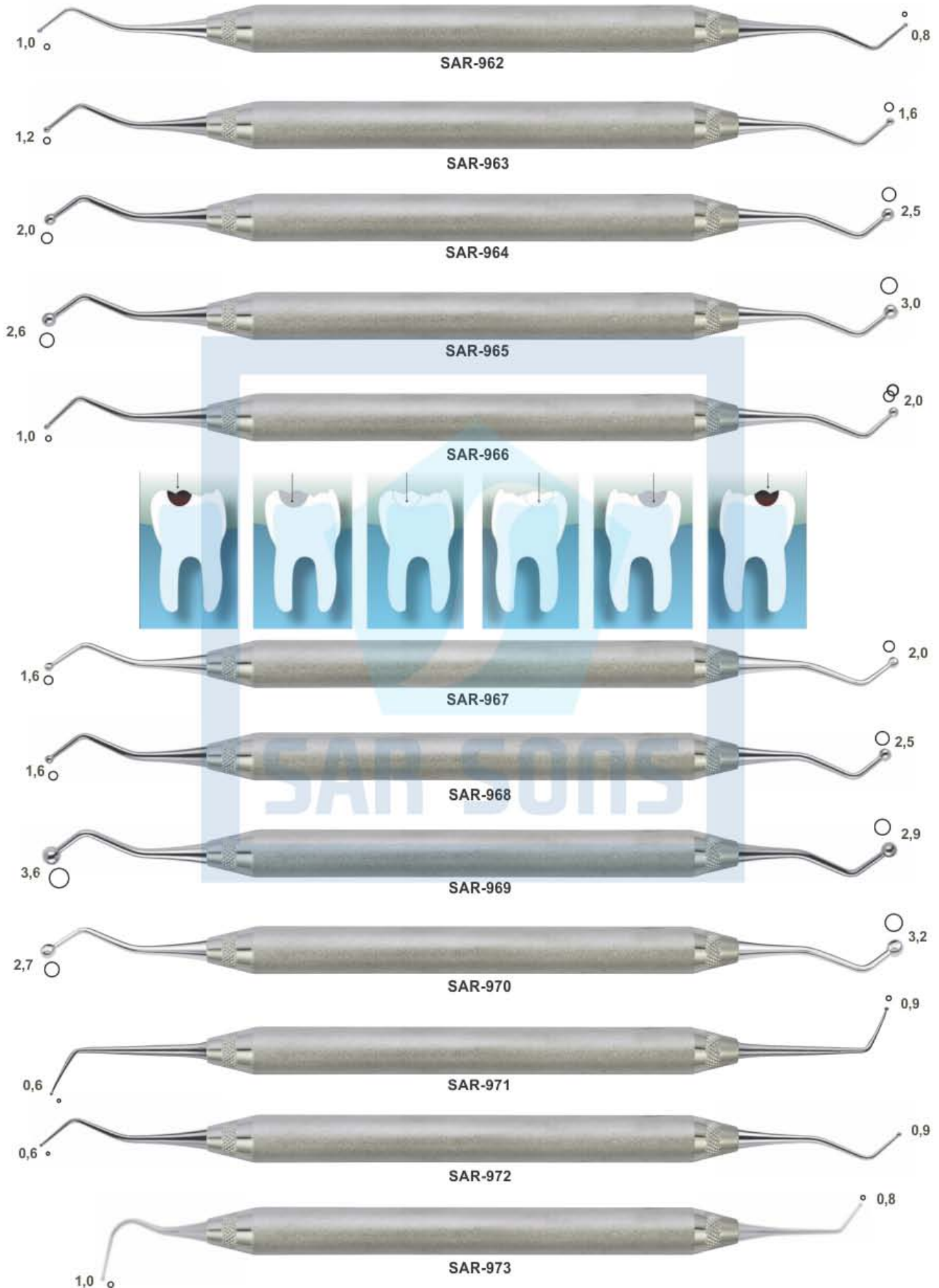

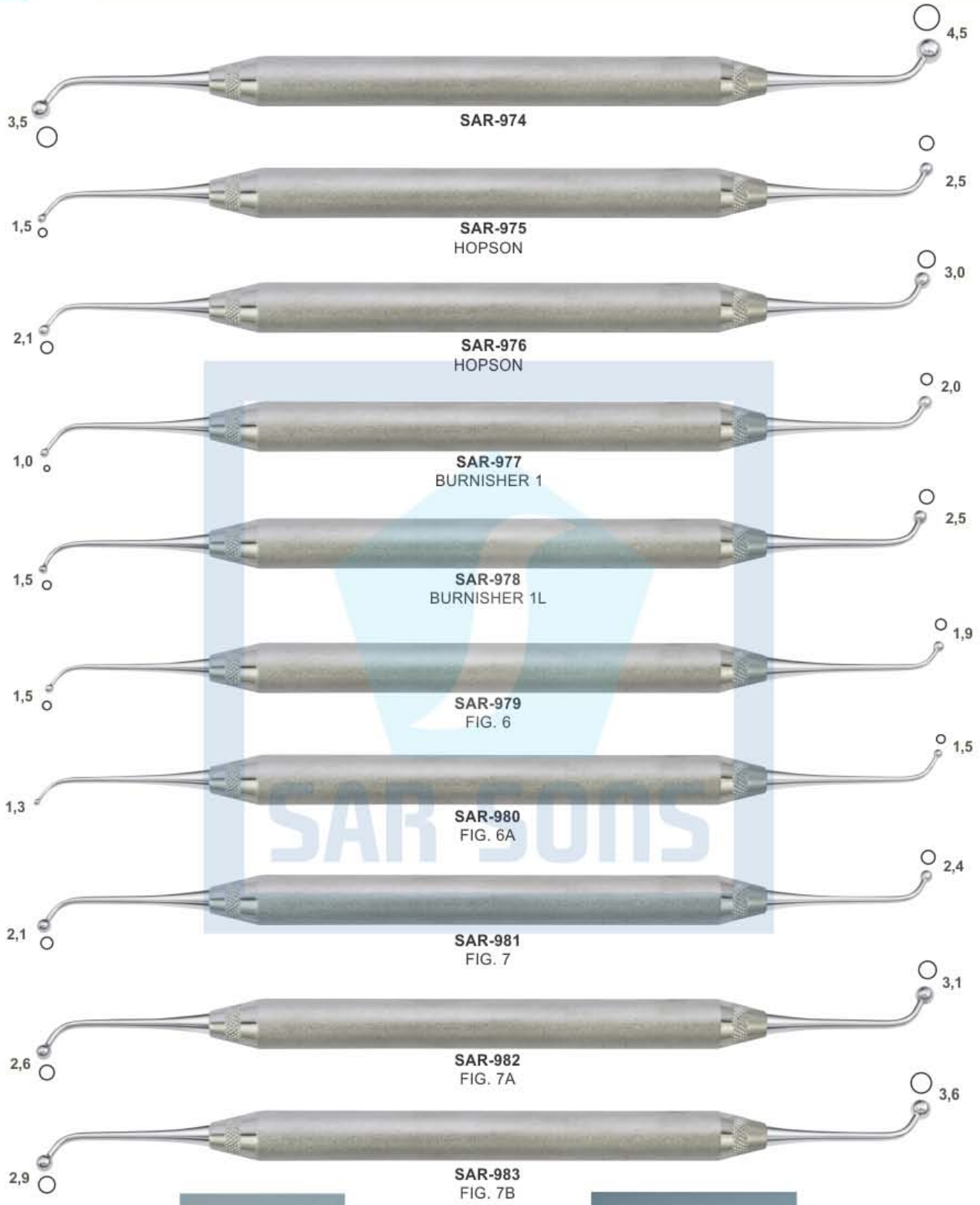

# FILLING INSTRUMENTS CONSERVATIVE TREATMENT

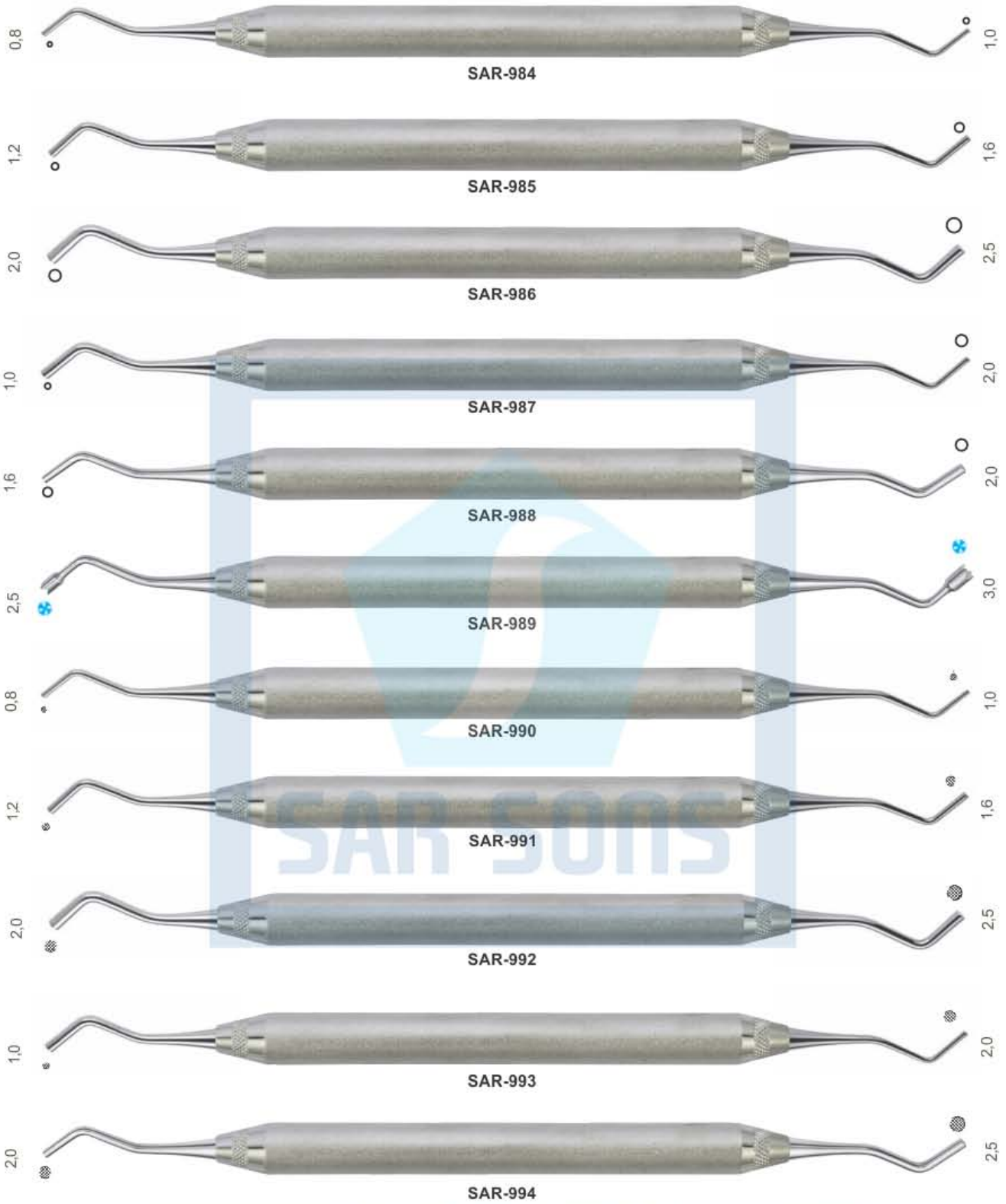

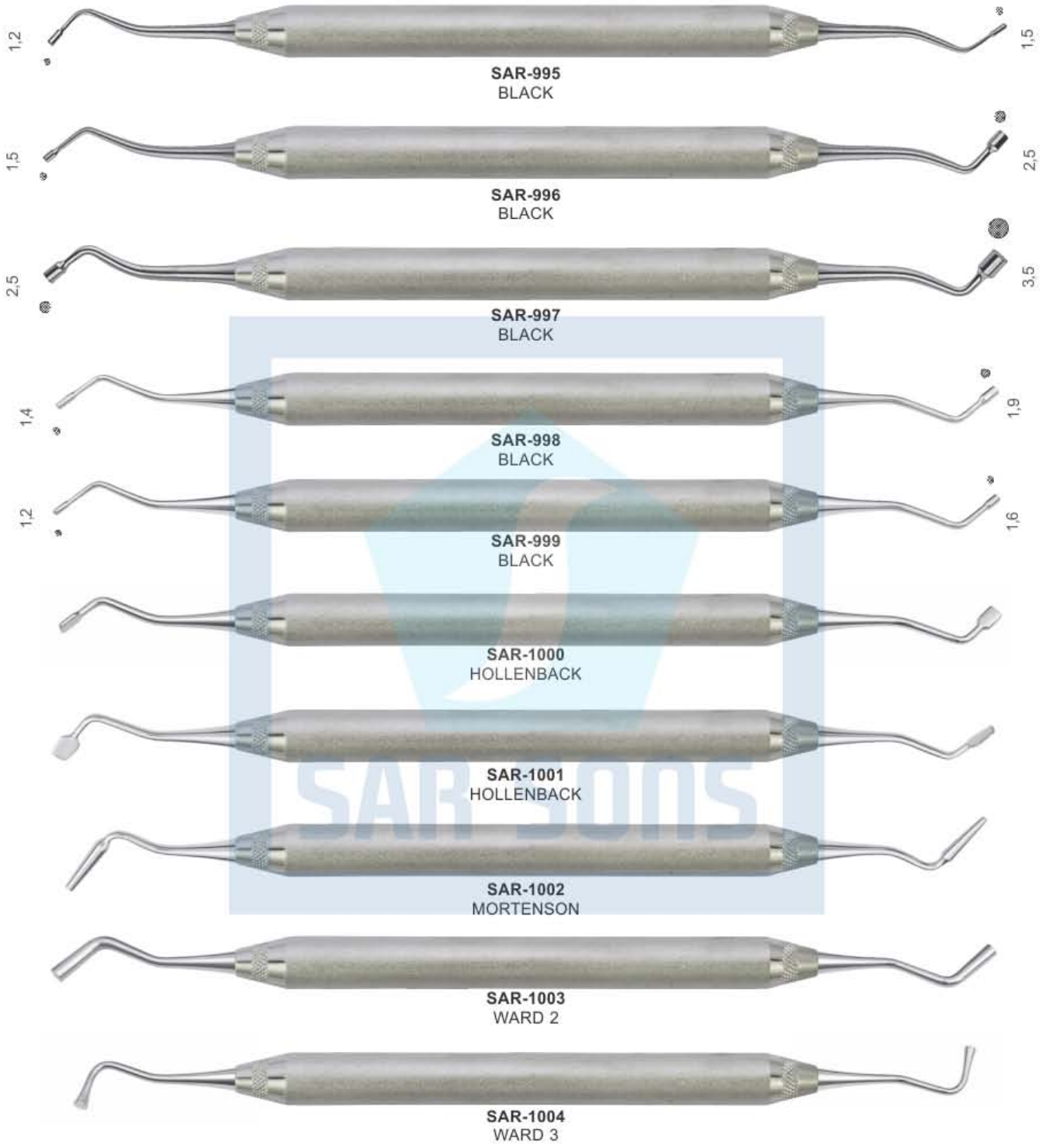



SAR-1005  
WILLIAMS



SAR-1006  
WILLIAMS



SAR-1007  
WILLIAMS



SAR-1008



SAR-1009



SAR-1010



SAR-1011



SAR-1012



SAR-1013



SAR-1014

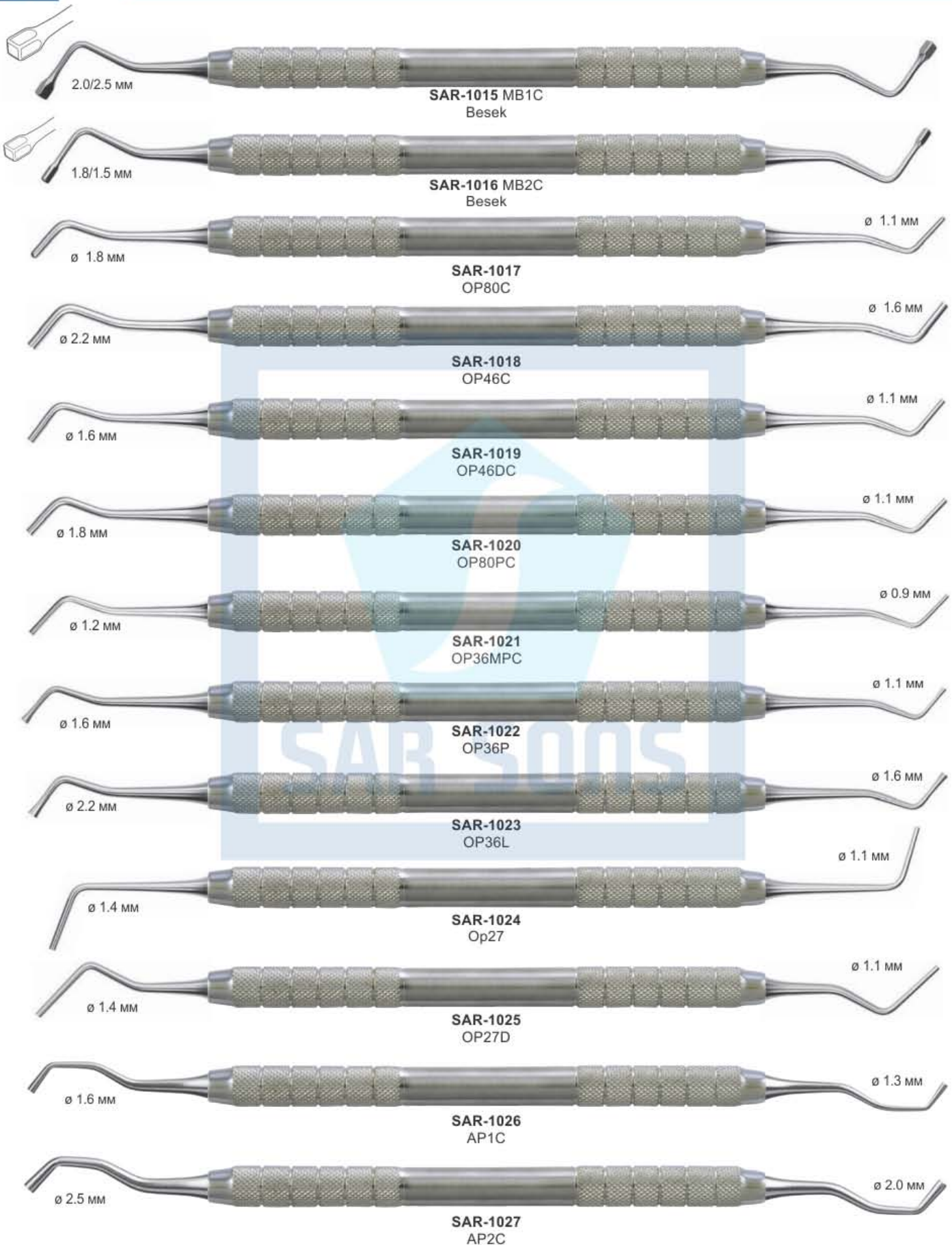



# COMPOSITE PLUGGERS INSTRUMENTS

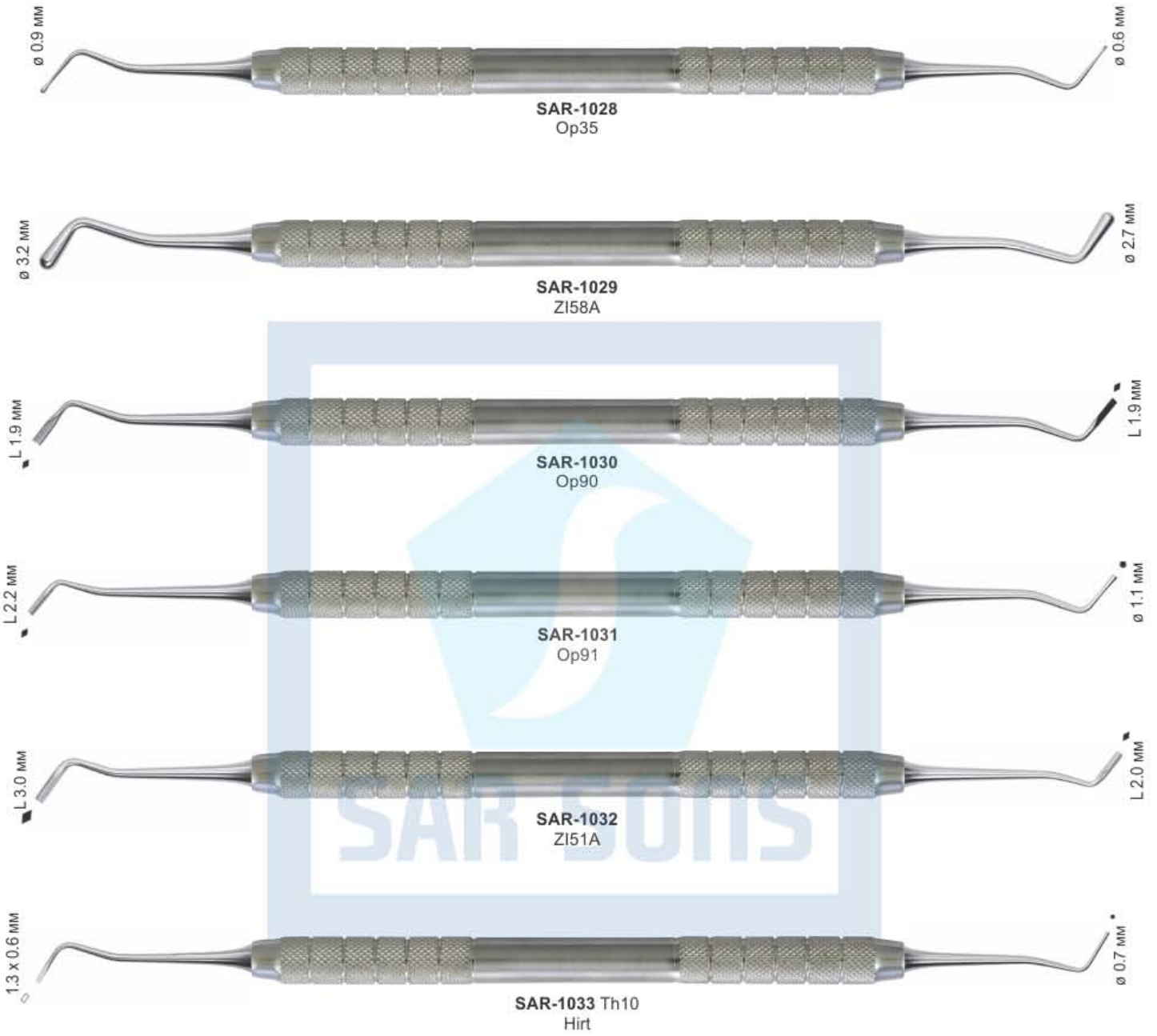

## Serrated Pluggers



Ø 0.9 MM		Ø 1.2 MM
	<b>SAR-1034</b> OP36M	
Ø 1.1 MM		Ø 1.6 MM
	<b>SAR-1035</b> OP36D	
Ø 1.6 MM		Ø 2.2 MM
	<b>SAR-1036</b> Op36	
Ø 1.0 MM		Ø 1.7 MM
	<b>SAR-1037</b> Op52	
Ø 2.2 MM		Ø 2.6 MM
	<b>SAR-1038</b> Zi51	
Ø 1.8 MM		Ø 2.2 MM
	<b>SAR-1039</b> Op44	
Ø 1.7 MM		Ø 2.6 MM
	<b>SAR-1040</b> 1BR2	
Ø 2.6 MM		Ø 3.6 MM
	<b>SAR-1041</b> 2BR3	



# COMPOSITE MODELLING INSTRUMENTS



**SAR-1042 MF2C**  
Fuzzi



**SAR-1043**  
Pj4



**SAR-1044 MB3C**  
Besek



**SAR-1045**  
HZ3C



**SAR-1046**  
CPRO3C



**SAR-1047 Mo1**  
Monari



**SAR-1048 TH28C**  
Hirt



**SAR-1049**  
HZ25C



**SAR-1050**  
Ck10



**SAR-1051**  
CK28BC



**SAR-1052 Op37**  
Carver



**SAR-1053**  
28BR29

## Round excavators

- Cariology**
- for the removal of softened, carious dentin
  - for the removal of temporary fillings
- Surgery**
- to sever the periodontal ligament prior to extraction
  - for the removal of granulation tissue after extraction
- Design: Round working end Curved cutting edge



Round Excavator, 1.0 mm  
SAR-1054



Round Excavator, 1.5 mm  
SAR-1055



Round Excavator, 2.0 mm  
SAR-1056

## Triple-angled back action excavators



Triple-angled Back Action Excavator, 1.0 mm  
SAR-1057



Triple-angled Back Action Excavator, 1.5 mm  
SAR-1058



Triple-angled Back Action Excavator, 2.0 mm  
SAR-1059



Triple-angled Back Action Excavator, 3.5 mm  
SAR-1060



# FILLING INSTRUMENTS

- Инструменты для реставрации
- Instruments pour plombage
- Füllungsinstrumente (mit Kontrawinkel)
- Інструменти для реставрації
- Instrumentos para obturaciones
- ملء الصكوك

COMPOSITE/PLASTIC FILLING INSTRUMENTS SOLID HANDLE 6MM, LENGTH 170MM

BLACK

PLUGGERS/CONDENSERS

Hollenback

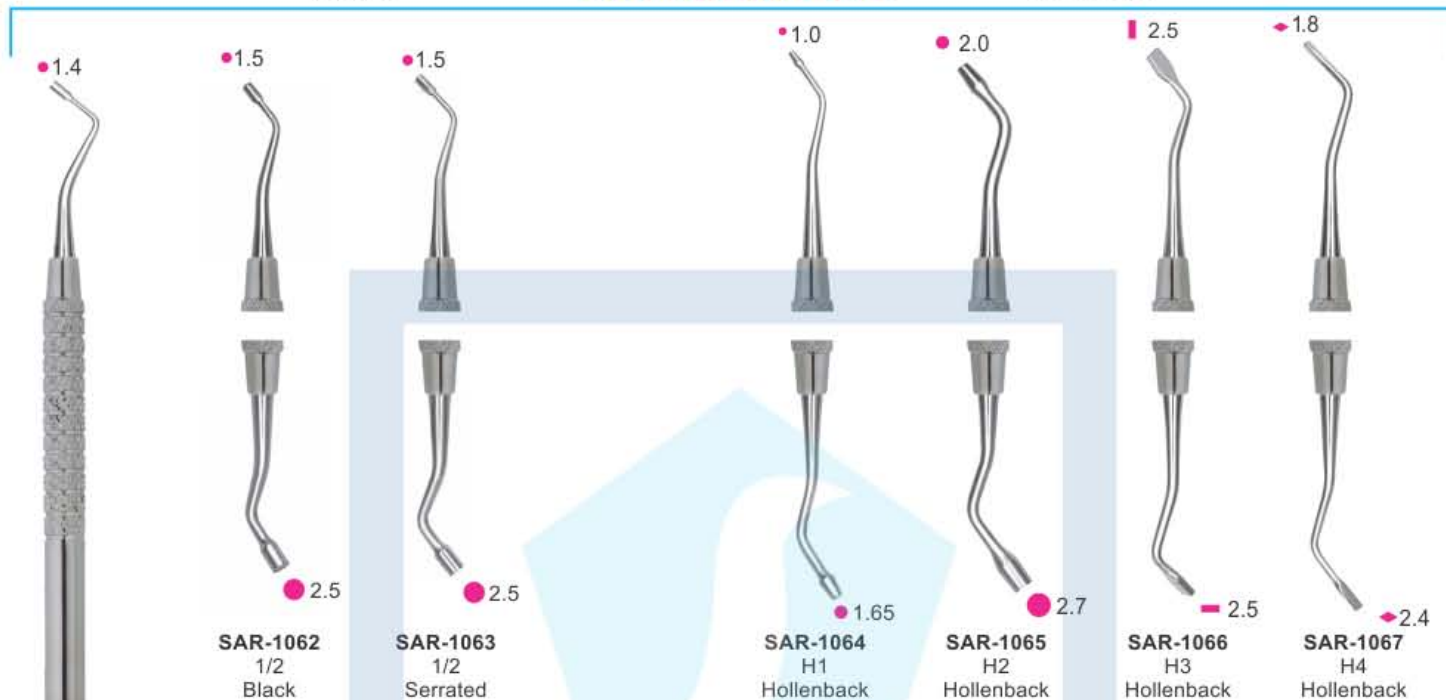

MARQUETTE CONDENSER

MORTONSON

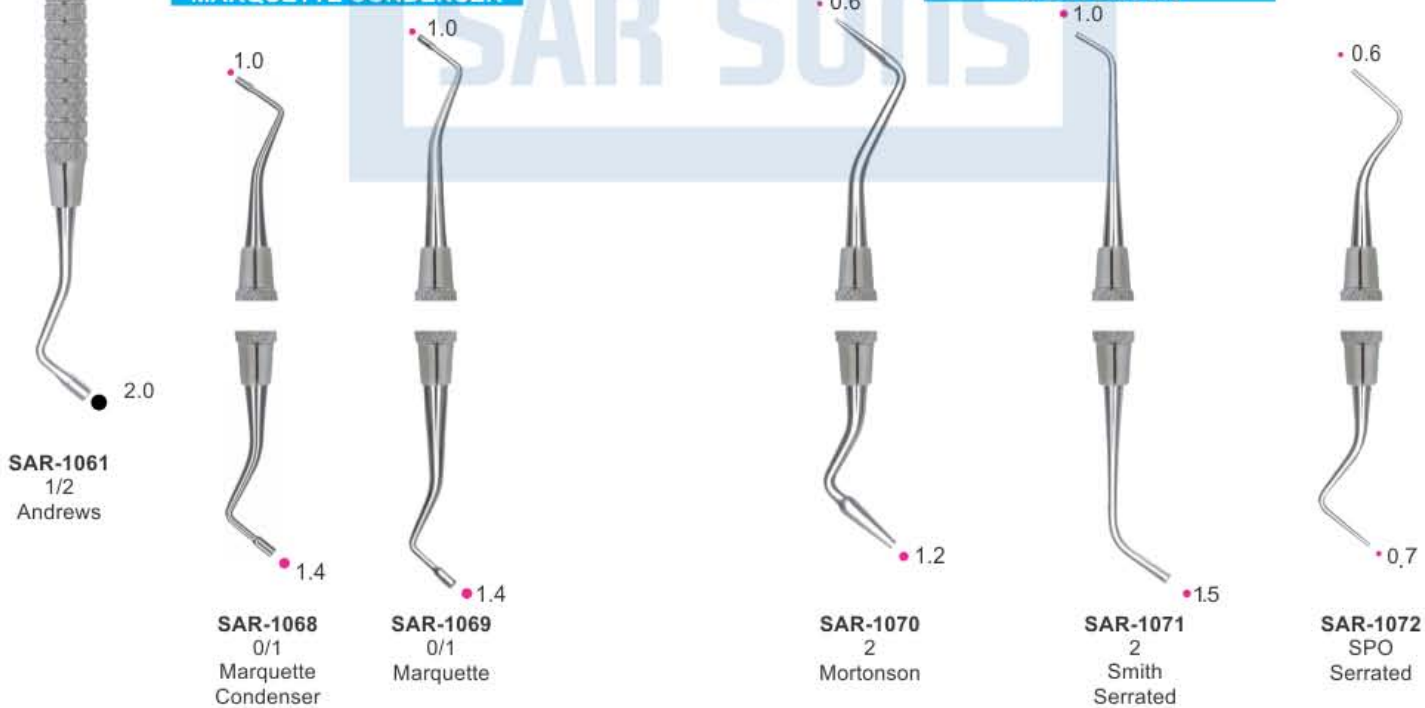

# FILLING INSTRUMENTS

- Инструменты для реставрации
- Instruments pour plombage
- Füllungsinstrumente (mit Kontrawinkel)
- Инструменти для реставрації
- Instrumentos para obturaciones
- ملء الصكوك

## RESTORATIVE INSTRUMENTS SOLID HANDLE 6MM, LENGTH 170MM Back Action Filling Instruments

### Tanner Filling Instruments

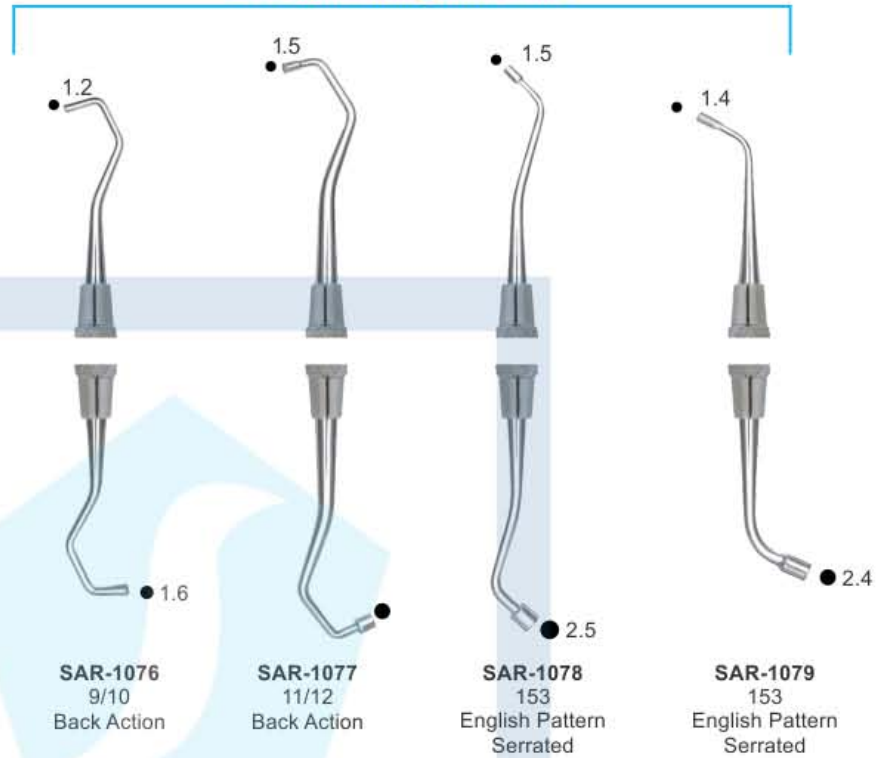
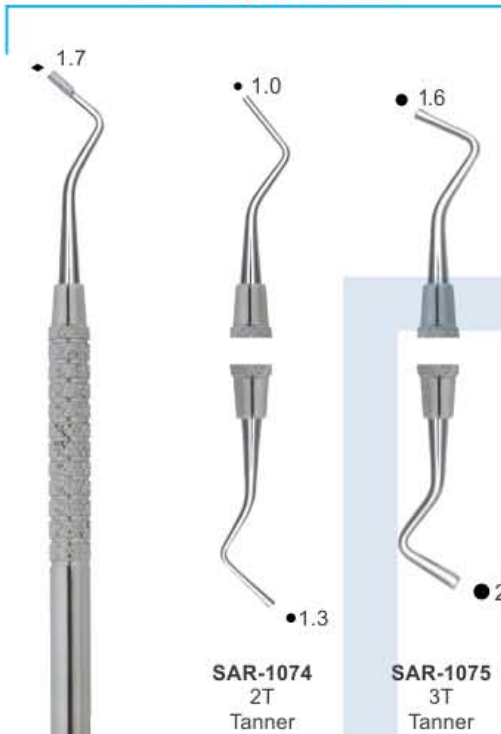

### BALL

### BURNISHERS

### BEAVERTAIL

### ACORN

### LADMORE

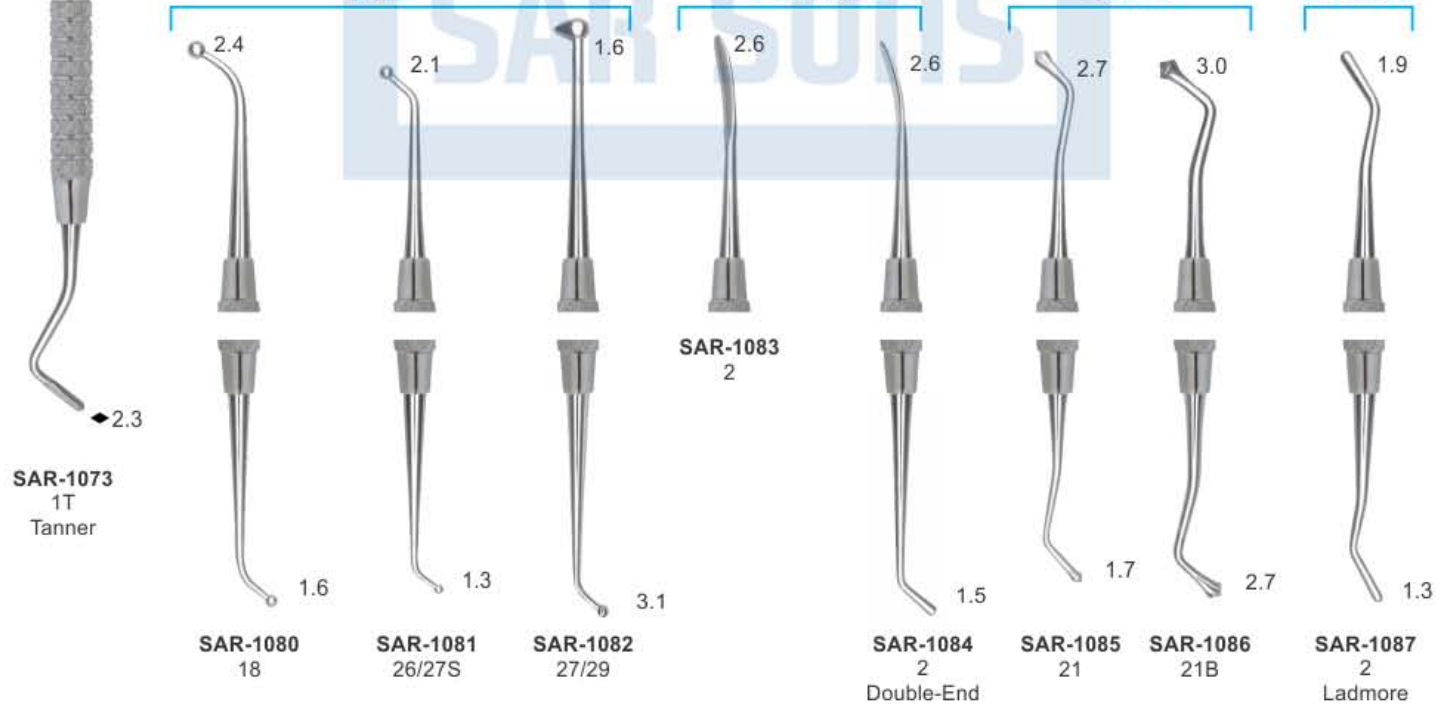

# CARVERS INSTRUMENTS



- Инструменты для реставрации
- Instruments a modeler
- Modellierinstrumente
- Инструменти для реставрації
- Instrumentos para modelar
- أدوات تقطيع

## P.K. THOMS WAXING INSTRUMENTS SOLID HANDLE 6mm



**SAR-1095**  
Composite Instruments Blue  
Titanium with Cassettes



**SAR-1094**  
P.k. Thomas Waxing Instruments Kit

## COMPOSITE INSTRUMENTS TITANIUM BLUE ENDODONTIC

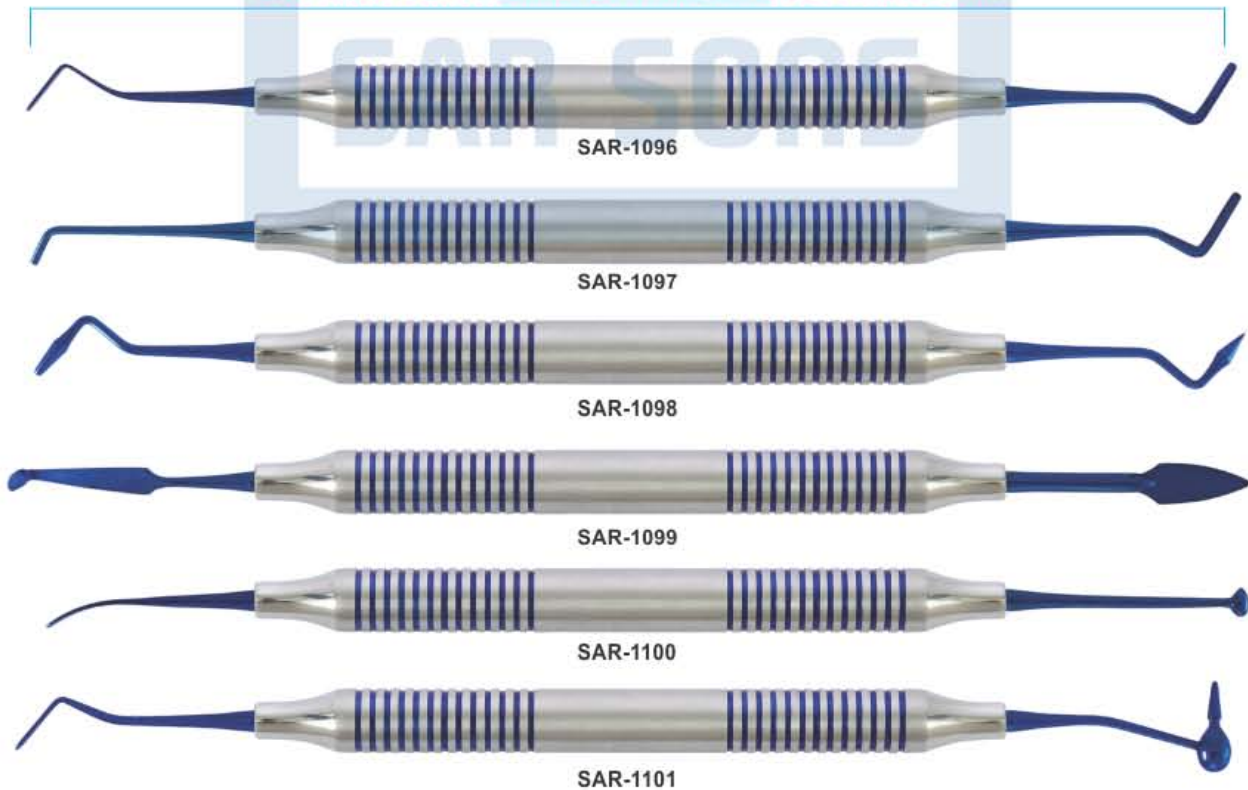

## CARVERS INSTRUMENTS

- Инструменты для реставрации
- Instruments a modeler
- Modellierinstrumente
- Инструменти для реставрації
- Instrumentos para modelar
- ادوات تقطیع



SAR-1102



SAR-1103



SAR-1104



SAR-1105



SAR-1106



Cassette For 5 Instruments  
SAR-1107



## FILLING INSTRUMENTS

- Инструменты для реставрации
- Instruments pour plombage
- Füllungsinstrumente (mit Kontrawinkel)
- Инструменти для реставрації
- Instrumentos para obturaciones
- ملء الصكوك

### FILLING INSTRUMENTS (Gold Pointed) SOLID HANDLE 6MM, LENGTH 170MM



## COMPOSITE FILLING INSTRUMENTS

- Инструменты для реставрации
- Instruments pour plombage
- Füllungsinstrumente (mit Kontrawinkel)
- Инструменти для реставрації
- Instrumentos para obturaciones
- ملء الصكوك

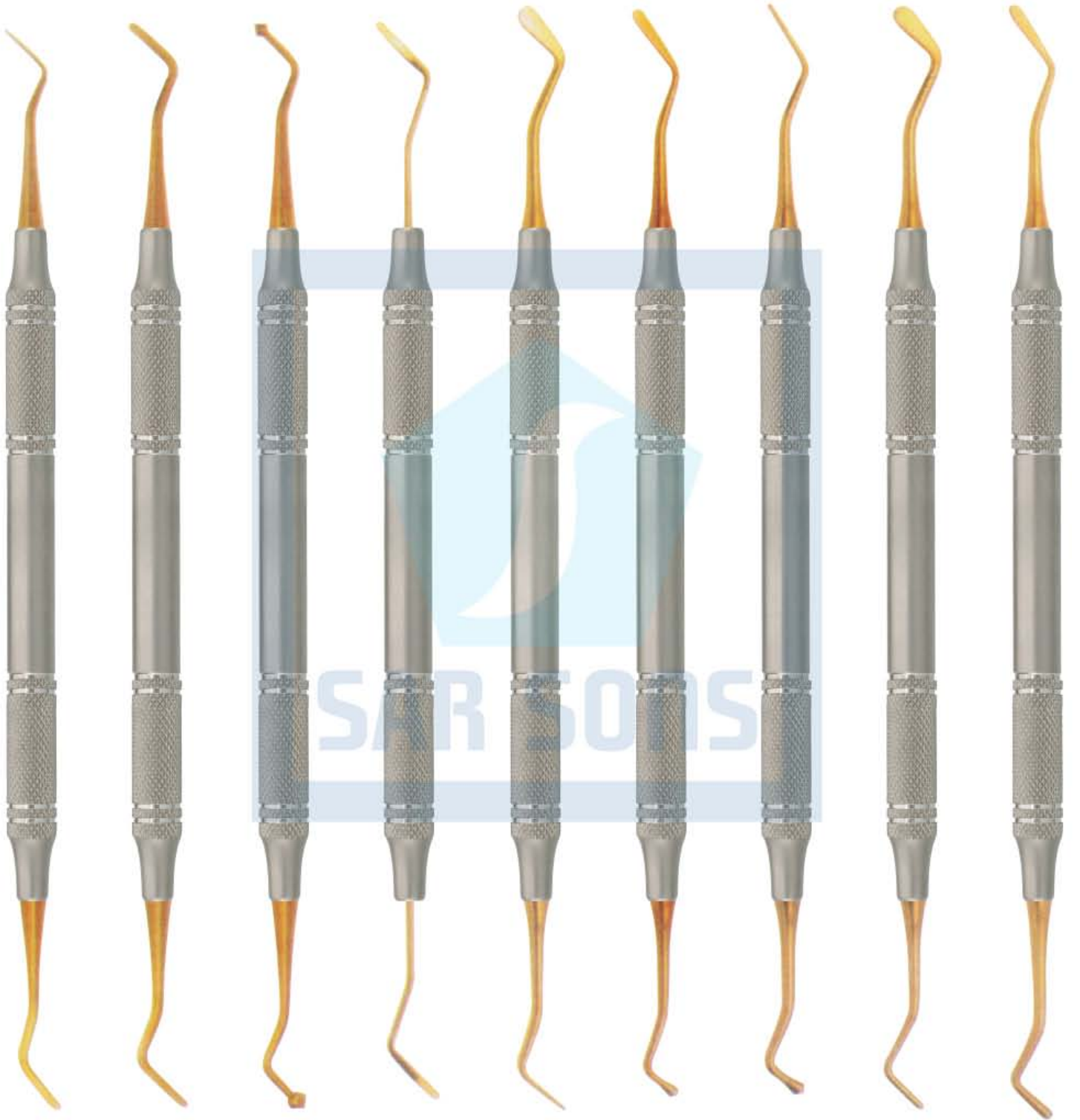

SAR-1118

SAR-1119

SAR-1120

SAR-1121

SAR-1122

SAR-1123

SAR-1124

SAR-1125

SAR-1126

# COMPOSITE FILLING INSTRUMENTS



- Инструменты для реставрации
- Instruments pour plombage
- Füllungsinstrumente (mit Kontrawinkel)
- Инструменти для реставрації
- Instrumentos para obturaciones
- ملء الصكوك

## Composite Gold Tip Instruments



## MISCELLANEOUS PRODUCTS

- Прочие товары
- Divers produits et services
- Sonstige Produkte
- Інші товари
- Varios Productos
- المنتجات المتنوعة



**SAR-1138**  
X Ray Film Hangers



**SAR-1139**  
X Ray Film Hangers



**SAR-1140**  
X Ray Film Hangers



**SAR-1141**  
X Ray Film Hangers



**SAR-1142**  
X Ray Film Hangers



**SAR-1143**  
X Ray Film Hangers



**SAR-1144**  
X Ray Film Hangers



**SAR-1145**



**SAR-1146**



**SAR-1147**



Dissecting Set  
**SAR-1148** Set of 9 Pcs.  
**SAR-1149** Set of 11 Pcs.



**SAR-1150**  
Napkin Holder with Plastic Chain

**SAR-1151**  
Napkin holder with metal chain



Mouth Props  
**SAR-1152**  
Small

Mouth Props  
**SAR-1153**  
Medium

Mouth Props  
**SAR-1154**  
Large

### Key Rings



**SAR-1155**



**SAR-1156**



**SAR-1157**



**SAR-1158**



**SAR-1159**



**SAR-1160**

## CEMENT SPATULAS

- Шпатели для цемента
- Spatules à ciment
- Zementspatel
- Шпателі для цементу
- Espátulas para cemento
- ملاعق الاسمنت

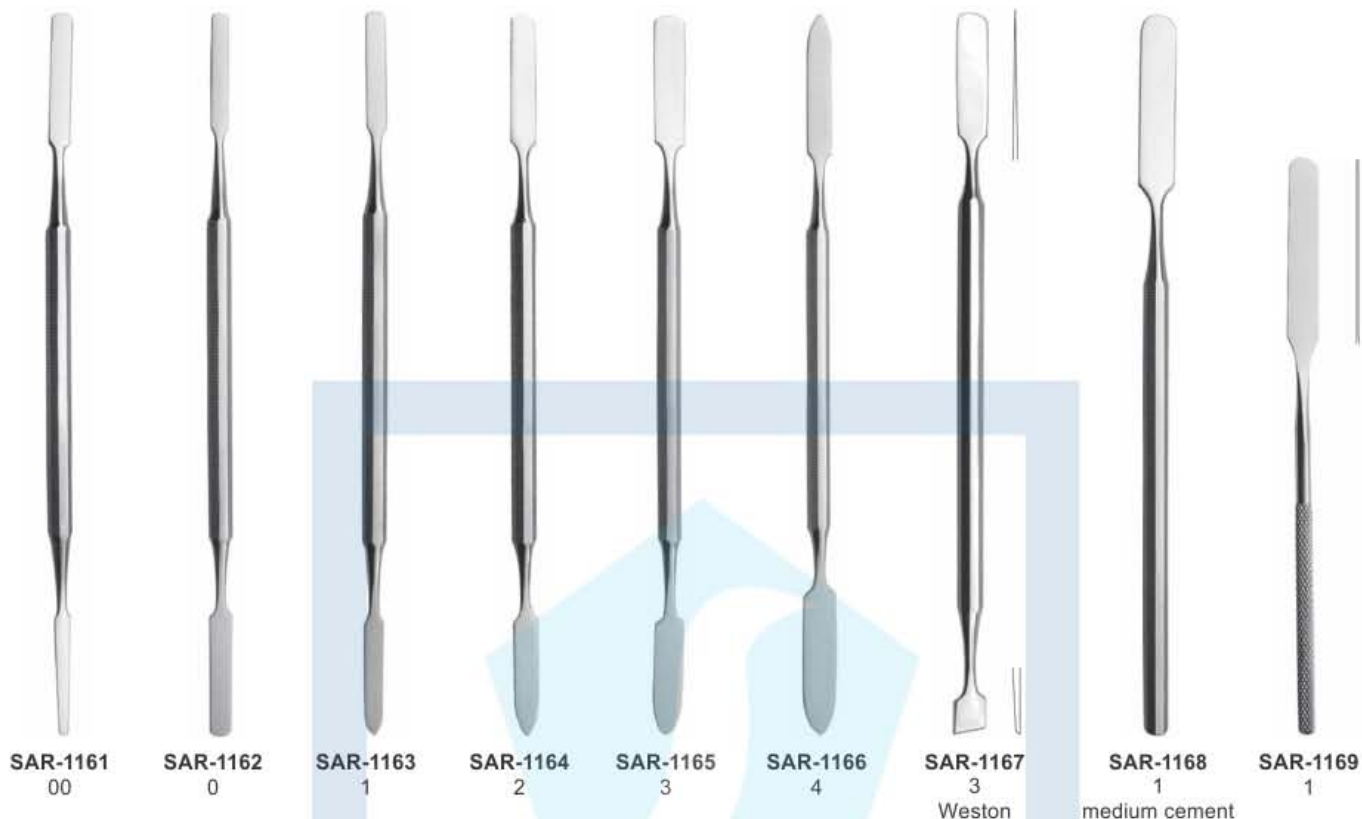

## WAX KNIVES

- Ножи для воска
  - Couteaux a cire
  - Wachsmesser
- Ножи для воску
  - Cuchillos para cera
  - السكاكين الشمع

ALGINATE, PLASTER SPATULAS, WAX KNIVES PLASTER FOR KNIVES & PLASTER SHEAR



**SAR-1183**  
Wooden Handle  
Fig. 5  
21.5 cm



**SAR-1184**  
Wooden Handle  
Fig. 7  
19.5 cm curved



**SAR-1185**  
Wooden Handle  
Fig. 8  
20 cm curved



**SAR-1186**  
Wooden Handle  
Fig. 9  
22.5 cm curved



**SAR-1187**  
Hook Knives



**SAR-1188**  
Fig. 1  
Lessmann  
12.5 cm



**SAR-1189**  
Fig. 2  
Lessmann  
17 cm



**SAR-1190**  
Fig. 1  
with small spoon  
12.5 cm



**SAR-1191**  
Fig. 2  
with large spoon  
17 cm



**SAR-1192**  
Bacolite Handle  
Wax Knives,  
Small



**SAR-1193**  
Bacolite Handle  
Wax Knives,  
Large



**SAR-1194**  
Wooden Handle  
Wax Knives,  
Small



**SAR-1195**  
Wooden Handle  
Wax Knives,  
Large



**SAR-1196**  
Plaster Knife



**SAR-1197**  
Fig. 1  
17 cm



**SAR-1198**  
Fig. 3  
16 cm



**SAR-1199**  
Fig. 4  
16 cm



**SAR-1200**  
Special Inox  
19.5 cm

# ARTICULATORS

- Артикуляторы
  - Artocilar
  - Artikulations
- Артикулятори
  - Articuler
  - ارتیکو لاتورس



**SAR-1201**

**Technical Datas:**

Intercondylar distance  
condylar inclination  
Bennet angle  
Incisal table inclination  
Distance between mounting plates  
Weight  
Opening (item 5000)  
Opening (item 5010)

120 mm.  
fixed at 30°  
fixed at 7°  
10°  
85 mm.  
400 gr.  
125°  
180°



**SAR-1202**

**Technical Datas:**

Intercondylar distance  
condylar inclination  
Bennet angle  
Incisal table inclination  
Distance between mounting plates  
Weight  
Opening

110 mm.  
fixed at 30°  
fixed at 7°  
flat  
85 mm.  
450 gr.  
180°



**SAR-1203**

Stainless Steel Finishing  
**SAR-1204**  
Royal Blue



**SAR-1205**



**SAR-1206**



**SAR-1207**



**SAR-1208**



**SAR-1209**

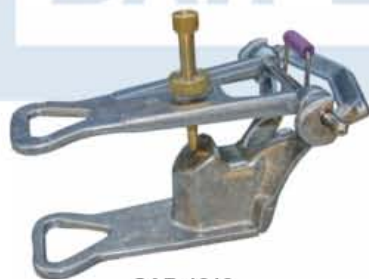

**SAR-1210**



**SAR-1211**



**SAR-1212**



**SAR-1213**



**SAR-1214**  
Nakawalni  
Dental Laboratory  
Instrument

# DENTAL PHOTOGRAPHIC MIRRORS

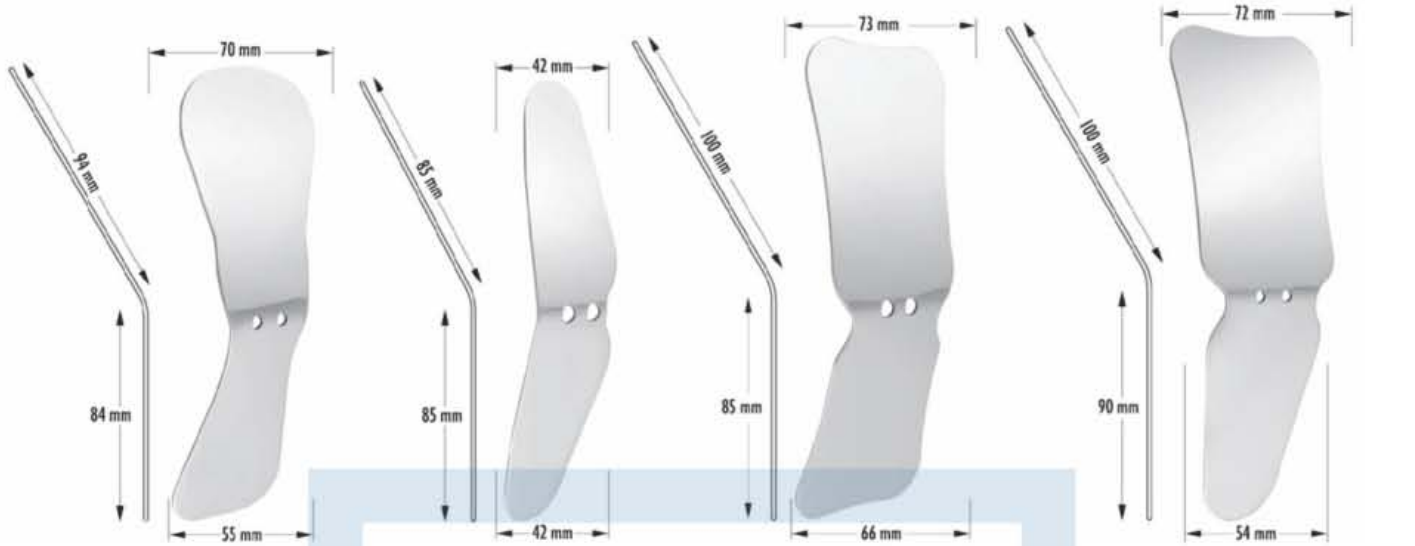

**SAR-1215** Adult Palatal /  
**SAR-1216** Child Palatal

**SAR-1217**  
Buccal

**SAR-1218** Adult Palatal /  
**SAR-1219** Child Palatal

**SAR-1220** Adult Palatal /  
**SAR-1221** Adult Buccal



**SAR-1222** Lingual upper /  
**SAR-1223** Lingual Lower

**SAR-1224** Adult Buccal /  
**SAR-1225** Child Buccal

**SAR-1226** Child Palatal /  
**SAR-1227** Child Buccal

**SAR-1228**  
Palatal-Adult

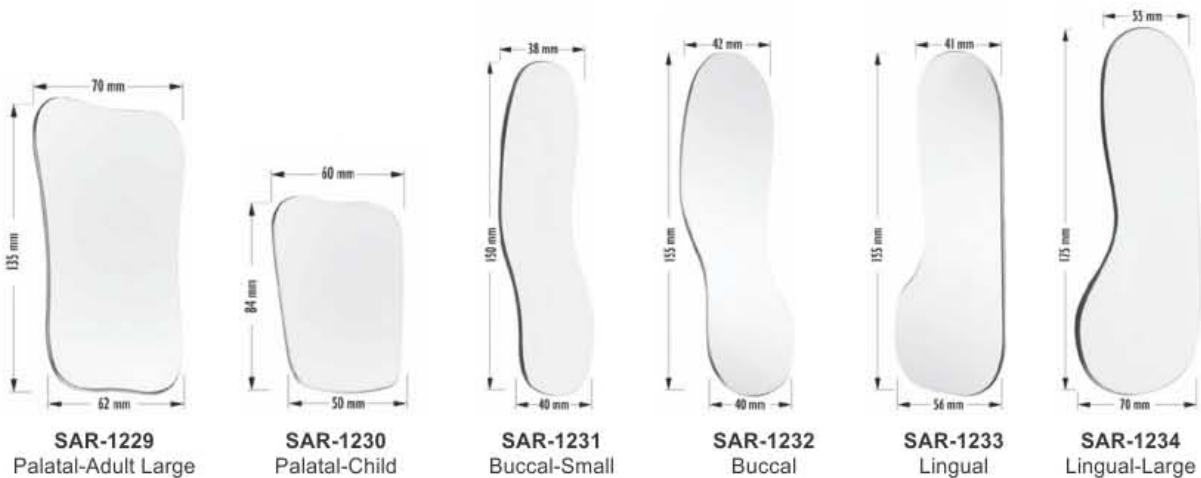

**SAR-1229**  
Palatal-Adult Large

**SAR-1230**  
Palatal-Child

**SAR-1231**  
Buccal-Small

**SAR-1232**  
Buccal

**SAR-1233**  
Lingual

**SAR-1234**  
Lingual-Large



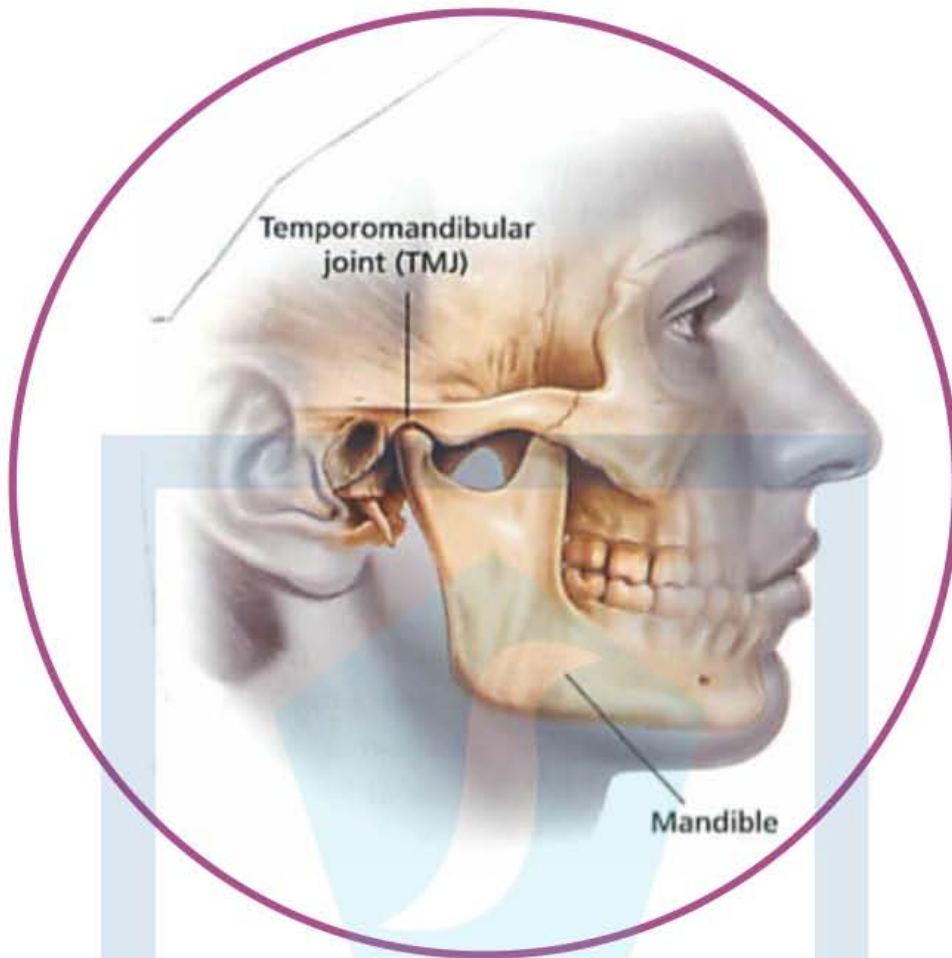

## RETRACTORS - MOUTH GAGS

- Роторасширители
- Ecarteurs - Ouvre-bouches
- Vestibulumabhalter / Mundspanner
- Роторозширювачі
- Separadores - Abre-bocas
- الكاشطات - الكمامات الفم



**SAR-1251**  
HMG  
Heister  
130mm



**SAR-1252**  
Mouth Gag Molt  
11 cm for (Children)



**SAR-1253**  
Mouth Gag Molt  
14 cm for (Adults)



**Sternberg Retractors**  
**SAR-1254** 140 mm  
**SAR-1255** 180 mm



**Columbia Retractor**  
**SAR-1256** 140 mm



**SAR-1257**  
Wangen Holder  
vestibule  
15 cm, with or without  
lip protection,



**SAR-1258**  
Wangen Holder  
vestibule 15 cm, with  
or without lip protection

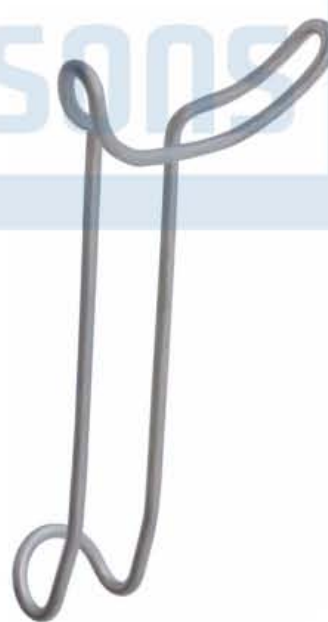

**SAR-1259**  
Wangen Holder  
with dual  
function, 17 cm



**Weider Retractor**



**SAR-1260**  
140 mm



**SAR-1261**  
150 mm

# RETRACTORS - MOUTH GAGS



- Роторасширители
- Ecarteurs - Ouvre-bouches
- Vestibulumabhalter / Mundspanner
- Роторозширювачі
- Separadores - Abre-bocas
- الكاشطات-الكمامات الفم



Weitlaner  
Fig. 1  
SAR-1262 10.5cm  
SAR-1263 13.5cm



Weitlaner  
Fig. 2  
SAR-1264 10.5cm  
SAR-1265 13.5cm



SAR-1266  
Lip & Cheek Retractor  
Stainless Steel  
Double Ended



SAR-1267  
Simplex Retractor  
Stainless Steel  
Single Ended

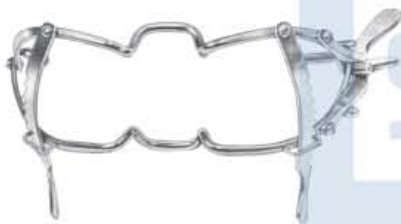

Weitlander  
SAR-1268 11cm  
SAR-1269 13cm  
SAR-1270 15cm



SAR-1274  
Denhard  
12 cm



SAR-1275  
Roser-König  
16 cm



SAR-1276  
Roser-König  
19 cm



Jennings  
SAR-1271 11cm  
SAR-1272 13cm  
SAR-1273 15cm

## RETRACTORS

- Ранорасширители
- Ecarteurs
- Wundhaken
- Ранорозширювачі
- Separadores
- الكاشحات

**Wound, Bendable**  
Retractor, individually or as saving kit!



**SAR-1277**  
Cheek Retainer  
One-sided  
Long



**SAR-1278**  
Cheek Retainer  
One-sided  
Long



**SAR-1279**  
Cheek Retainer  
One-sided  
Long



**Ergo Grip  
Retractor**  
**SAR-1280** 24 cm  
ergonomic handle,



**Ivory Retractors**  
Width adjustable  
& fixable,  
**SAR-1281** 20 cm



**Bruenings Retractors**  
tongue depressors  
**SAR-1282** 19 cm



**Minnesota  
Retractors**  
**SAR-1283** 16 cm



**Ribbon Retractors**  
**SAR-1284** 20 cm  
easy to bend  
by hand,



**Bishop Retractors**  
retractor and tongue  
pushers Bishop with  
comfortable margin  
**SAR-1285** 16 cm



**Combination  
Retractors**  
**SAR-1286** 25 cm

## RETRACTORS

- Ранорасширители
  - Ecarteurs
  - Wundhaken
- Ранорозширювачі
  - Separadores
  - الكاشطات



**SAR-1287**  
Unique Retractors  
Length 175 mm  
angled 45°



**SAR-1288**  
Unique Retractors  
Length 175 mm  
angled 90°



**SAR-1289**  
Retractors  
16cm



**SAR-1290**  
Retractors  
19cm



**SAR-1291**  
Mini-Langenbeck  
Retractors  
16 cm, hooks 22 mm



**SAR-1292**  
US army Retractors  
21 cm, 2



**SAR-1293**  
ALM Retractor  
about 8 cm



**SAR-1294**  
Senn Mueller Retractor  
17 cm, hooks 22 mm

## RETRACTORS

- Ранорасширители
- Ecarteurs
- Wundhaken
- Ранорозширювачі
- Separadores
- الكاشحات



**SAR-1295**  
Langenbeck Retractors  
surgical-flat  
21 cm, hook  
30x16 mm



**SAR-1296**  
Langenbeck Retractors  
surgical-flat  
21 cm, hook  
42x11 mm



**SAR-1297**  
Langenbeck Retractors  
surgical-flat  
21 cm, hook  
63x12 mm



Langenbeck Retractors  
surgical-flat  
21 cm, hook  
**SAR-1298** 30x16 mm  
**SAR-1299** 42x11 mm  
**SAR-1300** 63x12 mm



Langenbeck Retractors  
21 cm, hook  
**SAR-1301** 30x11 mm  
**SAR-1302** 30x16 mm



**SAR-1303**  
Middelborpf  
Retractors  
21 cm

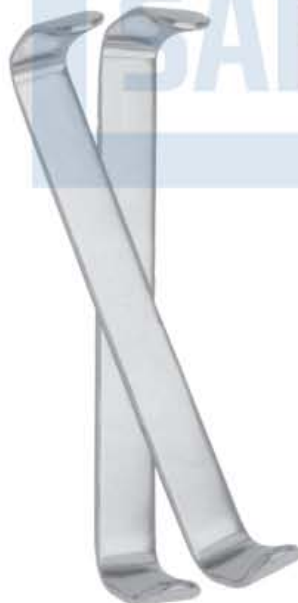

**SAR-1304**  
Farabeuf  
(120 X 12mm  
Set of 2 pices)



**SAR-1305**  
Retractor Seldin



**SAR-1306**  
Feldman Retractor  
14cm

# GUM SCISSORS



- Ножницы десневые
- Ciseaux a gencives
- Zahnfleischscheren
- Ножці для ясен
- Tijeras para encias
- مقص صمغ



**SAR-1307**  
Iris  
115mm  
Straight

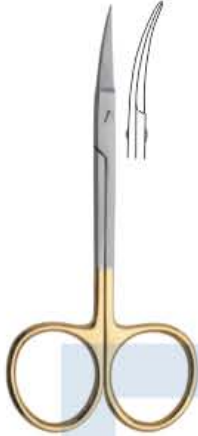

**SAR-1308**  
Iris  
115mm  
Curved



**SAR-1309**  
Goldman-Fox  
130mm  
Saw edge, straight



**SAR-1310**  
Goldman-Fox  
130mm  
Saw edge, Curved



**SAR-1311**  
La Grange  
115mm  
Saw edge, double Curved



Mayo  
**SAR-1312** 140mm  
**SAR-1313** 170mm  
**SAR-1314** 230mm  
Straight



Mayo  
**SAR-1315** 140mm  
**SAR-1316** 170mm  
**SAR-1317** 230mm  
Curved



Metzenbaum  
**SAR-1318** 145mm  
**SAR-1319** 180mm  
**SAR-1320** 200mm  
Straight



Metzenbaum  
**SAR-1321** 145mm  
**SAR-1322** 180mm  
**SAR-1323** 200mm  
Curved



**SAR-1324**  
Kelly  
160mm  
Straight



**SAR-1325**  
Kelly  
160mm  
Curved

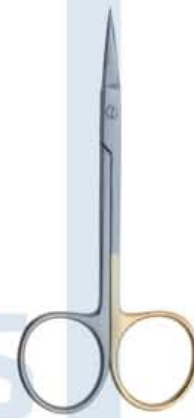

**SAR-1326**  
Iris  
115mm  
Straight



**SAR-1327**  
Iris  
115mm  
Curved



**SAR-1328**  
La Grange  
115mm  
Double Curved



**SAR-1329**  
Goldman-Fox  
130mm, Straight



**SAR-1330**  
Goldman-Fox  
130mm, Curved



**SAR-1331**  
Kelly  
160mm, Curved



**SAR-1332**  
Iris  
115mm, Straight



**SAR-1333**  
Iris  
115mm, Curved



**SAR-1334**  
Micro Iris  
90mm, Curved

## GUM SCISSORS

- Ножницы десневые
- Ciseaux a gengives
- Zahnfleissscheren
- Ножиці для ясен
- Tijeras para encias
- مقص صمغ





## GUM SCISSORS

## NEEDLE HOLDERS

- Ножницы десневые
- Ciseaux a gencives
- Zahnfleischscheren

- Ножиці для ясен
- Tijeras para encias
- مقص صمغ

- Иглодержатели
- Porte-aiguilles
- Nadelhalter

- Голкотримачі
- Porta-agujas
- اصحاب ابرة



**SAR-1359**  
130mm  
Straight



**SAR-1360** Mayo 130mm  
**SAR-1361** Mayo 160mm  
**SAR-1362** Mayo 180mm  
Straight Curved



**SAR-1363** Mayo 140mm  
**SAR-1364** Mayo 200mm  
Straight Curved



**SAR-1365** Metzzenbaum 145mm  
**SAR-1366** Metzzenbaum 200mm  
Straight Curved



**SAR-1367**  
Beebee  
110mm  
Saw edge,  
straight



**SAR-1368**  
Beebee  
110mm  
Saw edge,  
curved



**SAR-1369**  
Beebe  
110mm  
Saw edge, straight



**SAR-1370**  
Beebe  
110mm  
Saw edge, curved

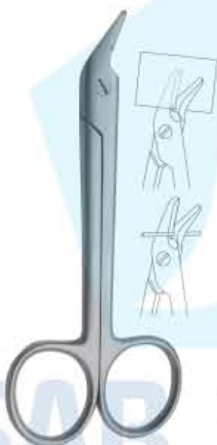

**SAR-1371**  
Universal  
120mm  
Saw edge



**SAR-1372**  
Universal  
120mm

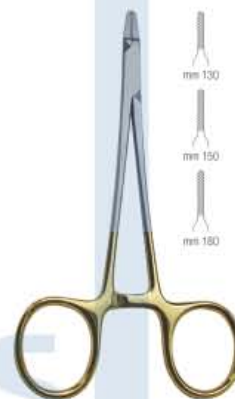

Ryder  
**SAR-1373** 130mm  
**SAR-1374** 150mm  
**SAR-1375** 180mm



**SAR-1376**  
Halsey  
130mm



**SAR-1377**  
Baumgartner  
130mm



**SAR-1378**  
Derf  
120mm



**SAR-1379**  
Delicate  
150mm



Mayo-Hegar  
**SAR-1380** 130mm  
**SAR-1381** 160mm  
**SAR-1382** 180mm  
**SAR-1383** 200mm



**SAR-1384**  
Crile-Wood  
150mm  
straight



**SAR-1385**  
Crile-Wood  
150mm  
curved

## NEEDLE HOLDERS

- Иглодержатели
- Porte-aiguilles
- Nadelhalter

- Голкотримачи
- Porta-agujas
- أصحاب إبرة

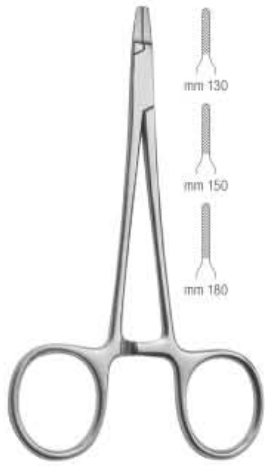

Ryder  
**SAR-1386** 130mm  
**SAR-1387** 150mm  
**SAR-1388** 180mm



**SAR-1389**  
 Halsey  
 130mm



**SAR-1390**  
 Baumgartner  
 130mm



**SAR-1391**  
 Derf  
 120mm



**SAR-1392**  
 Delicate  
 150mm



**SAR-1393**  
 Adson  
 170mm



Mayo-Hegar  
**SAR-1394** 130mm  
**SAR-1395** 160mm  
**SAR-1396** 180mm  
**SAR-1397** 200mm



**SAR-1398**  
 Crile-Wood  
 150mm



Castroviejo  
**SAR-1399** str 140mm cvd  
**SAR-1400** str 180mm cvd



Olsen-Hegar Needle  
 Holder With Scissors  
**SAR-1401** 140mm



Gillies Needle  
 Holder With Scissors  
**SAR-1402** 160mm



Mathieu  
**SAR-1403** 140mm  
**SAR-1404** 170mm



Castroviejo  
**SAR-1405** str 140mm cvd  
**SAR-1406** str 180mm cvd



Olsen-Hegar Needle  
 Holder With Scissors  
**SAR-1407** 140mm



Gillies Needle  
 Holder With Scissors  
**SAR-1408** 160mm

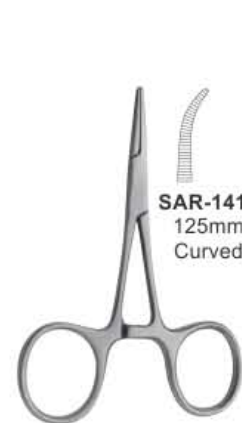

Hartmann (Baby  
 Mosquito)  
**SAR-1409** 90mm straight



Halstead Mosquito  
**SAR-1411** 125mm  
 Straight

**SAR-1410**  
 125mm  
 Curved

**SAR-1412**  
 Curved

## GUM SCISSORS

- Ножницы десневые
- Ciseaux a gencives
- Zahnfleischscheren
- Ножці для ясен
- Tijeras para encias
- مقص صمغ



**SAR-1413**  
Goldman Fox Scissors  
12.5cm Curved



**SAR-1414**  
Iris Scissors  
11.5cm Curved  
Serrated For Slip-Free Cutting



**SAR-1415**  
LaGrange Scissors  
11.5cm Double Curved  
Serrated For Slip-Free Cutting

Double  
Curved



**SAR-1416**  
Castroviejo Micro Scissors  
12cm Curved



**SAR-1417**  
Super Cut Goldman Fox  
13.2cm Curved  
Serrated For Slip-Free Cutting

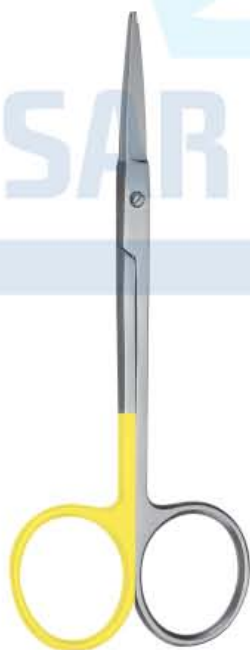

**SAR-1418**  
Super Cut Iris  
11cm Straight  
Serrated For Slip-Free Cutting



**SAR-1419**  
Super Cut LaGrange  
11cm Curved  
Serrated For Slip-Free Cutting



**SAR-1420**  
Super Cut LaGrange  
11.5cm  
Double Curved  
Serrated For Slip-Free Cutting

Double  
Curved

## NEEDLE HOLDERS

- Иглодержатели
- Porte-aiguilles
- Nadelhalter

- Голкотримачи
- Porta-agujas
- اصحاب ابرة



**SAR-1421**  
Lichtenberg-  
Ryder T.C  
14 cm



**SAR-1422**  
Lichtenberg-  
Ryder T.C  
14 cm



**SAR-1423**  
Lichtenberg-  
Ryder T.C  
17 cm



**SAR-1424**  
Lichtenberg-  
Ryder T.C  
17 cm



**SAR-1425**  
Barraquer  
18 cm



**SAR-1426**  
Barraquer  
18 cm



**SAR-1427**  
Barraquer T.C  
18 cm



**SAR-1428**  
Barraquer T.C  
18 cm



**SAR-1429**  
Tönnis  
18 cm



**SAR-1430**  
Castroviejo  
13 cm  
Straight



**SAR-1431**  
Kalt Needle Holders T.C  
14 cm Straight



**SAR-1432**  
Peet Splinter Forceps  
11.5 cm

**SAR-1433**  
La Grange  
Curved



**SAR-1434**  
All-Purpose Pliers

## HAEMOSTATIC FORCEPS & TOWEL CLAMPS

- Зажимы артериальные, зажимы для салфеток
- Pincers hemostatiques, Pincers a compresses
- Arterienklemmen, Tuschklemmen
- Затискачі артеріальні, затискачі для серветок
- Pinzas hemostaticas, Pincers para compressas
- الملقط هيموستاتيک المشابك منشفة

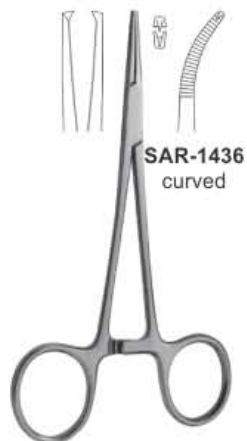

**SAR-1436**  
curved

Halstead Mosquito 1x2  
**SAR-1435** 125mm  
straight



**SAR-1438**  
curved

Kelly  
**SAR-1437** 140mm  
straight

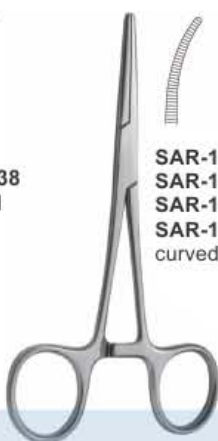

**SAR-1443** 140mm  
**SAR-1444** 160mm  
**SAR-1445** 180mm  
**SAR-1446** 200mm  
curved

Rochester-Pean  
**SAR-1439** 140mm  
**SAR-1440** 160mm  
**SAR-1441** 180mm  
**SAR-1442** 200mm  
straight

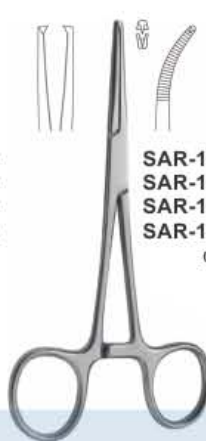

**SAR-1451** 140mm  
**SAR-1452** 160mm  
**SAR-1453** 180mm  
**SAR-1454** 200mm  
curved

Rochester-Kocher 1x2  
**SAR-1447** 140mm  
**SAR-1448** 160mm  
**SAR-1449** 180mm  
**SAR-1450** 200mm  
straight



**SAR-1456**  
curved

**SAR-1455**  
Kelly-Rankin  
160mm  
straight



Lorna  
**SAR-1457** 100mm  
**SAR-1458** 130mm

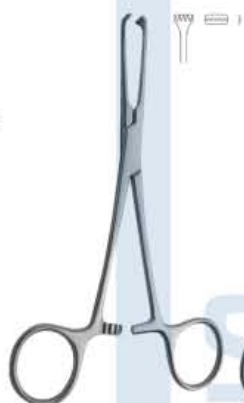

**SAR-1459**  
Allis-Baby 3:4  
150mm



**SAR-1460**  
Allis 4:5  
200mm



**SAR-1461**  
Allis 6:7  
200mm

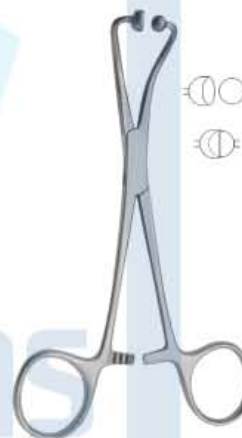

Ball Socket  
**SAR-1462** 140mm  
Not-perforating and  
not-damaging



**SAR-1463**  
Backhaus  
130mm



**SAR-1464**  
Backhaus  
85mm



**SAR-1465**  
Jones  
90mm

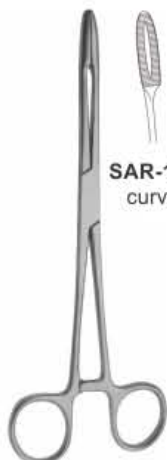

**SAR-1139**  
curved

Gross Maier  
Dressing Forceps  
**SAR-1466** 200mm straight



Foerster  
Dressing Forceps  
**SAR-1467** 200mm



Spare rubber

Young  
Tongue Forceps  
**SAR-1468** 170mm



Collins  
Tongue Forceps  
**SAR-1469** 170mm

## RUBBER DAM CLAMPS FORCEPS

- Инструменты для системы коффердам
- Pincas porte-crampons a digue
- Kofferdam Klammerzangen
- Инструменти для системи коффердам
- Pinzas de engrapar para dique de caucho
- السد العطاء الملقط المشابيك



### SAR-1470

On request the Content of the rubber dam kit can be changed with other instruments.

#### Content:

- 01 Anisworth
- 02 Brewer
- 03 Clamps Stand
- 04 Denture Plate
- 05 Rubber Dam Frame
- 06 Rubber Dam Box Lower Case
- 07 Rubber Dam Box Upper Case
- 08 Rubber Dam Clamp Fig. 212
- 09 Rubber Dam Clamp Fig. 211
- 10 Rubber Dam Clamp Fig. 8
- 11 Rubber Dam Clamp Fig. 8A
- 12 Rubber Dam Clamp Fig. 14
- 13 Rubber Dam Clamp Fig. 14A
- 14 Rubber Dam Clamp Fig. 0
- 15 Rubber Dam Clamp Fig. 00
- 16 Rubber Dam Clamp Fig. 2
- 17 Rubber Dam Clamp Fig. 2A
- 18 Rubber Dam Clamp Fig. 7

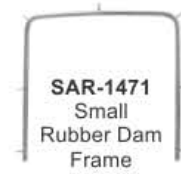

**SAR-1471**  
Small  
Rubber Dam  
Frame

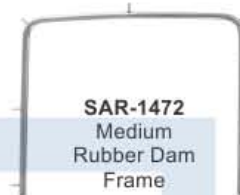

**SAR-1472**  
Medium  
Rubber Dam  
Frame

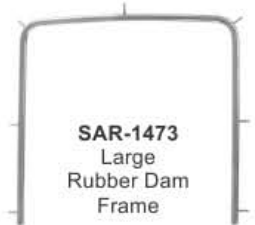

**SAR-1473**  
Large  
Rubber Dam  
Frame

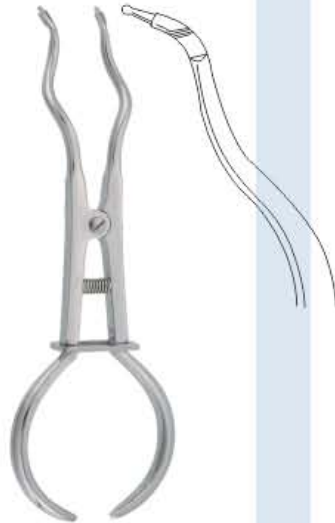

**SAR-1474**  
Brewer



**SAR-1475**  
Stockes

**SAR-1476**  
Palmer



**SAR-1477**  
Ivory light weight



**SAR-1478**  
Anisworth



**SAR-1479**  
Anisworth

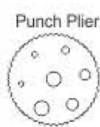

Punch Plier



**SAR-1480**  
Anisworth



**SAR-1481**  
Ivory



**SAR-1482**  
Separating  
Elastic Plier

## RUBBER DAM CLAMPS KITS

- Резиновая дамба зажимы комплекты
- Trousses de caoutchouc
- Gummidammklammern
- Гумова дамба затискачі комплекти
- Conjuntos de abrazaderas de retención de caucho
- المطاط السد المشابك مجموعات



**SAR-1483**

Stainless Steel Gold Plated Rubber Dam Clamp Tray with 11 Different Clamps  
Fig. 212, 211, 8, 8A, 14, 14A, 0, 00, 2, 2A, 7



**SAR-1484**

Stainless Steel Rubber Dam Clamp Tray with 12 Different Clamps  
Fig. 209, 212, 211, 8, 8A, 14, 14A, 0, 00, 2, 2A, 7



**SAR-1485**

Stainless Steel Rubber Dam Clamp Tray with 8 Different Clamps  
Fig. 1, 26, 29, 51, 60, 202, 205, 210

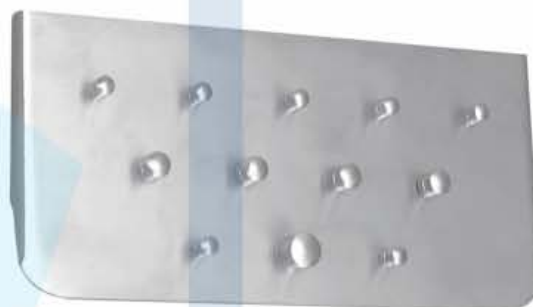

**SAR-1486**

Stainless Steel Rubber Dam Clamp Tray  
(without clamps)



**SAR-1487**

On request the Content of the rubber dam kit can be changed with other instruments.

**Content:**

- |                              |                              |
|------------------------------|------------------------------|
| 01 Ivory                     | 08 Rubber Dam Clamp Fig. 209 |
| 02 Ivory light weight        | 09 Rubber Dam Clamp Fig. 212 |
| 03 Clamps Stand              | 10 Rubber Dam Clamp Fig. 211 |
| 04 Rubber Dam Frame M        | 11 Rubber Dam Clamp Fig. 8   |
| 05 Rubber Dam Frame L        | 12 Rubber Dam Clamp Fig. 8A  |
| 06 Rubber Dam Box Lower Case | 13 Rubber Dam Clamp Fig. 14  |
| 07 Rubber Dam Box Upper Case | 14 Rubber Dam Clamp Fig. 14A |
|                              | 15 Rubber Dam Clamp Fig. 0   |
|                              | 16 Rubber Dam Clamp Fig. 00  |
|                              | 17 Rubber Dam Clamp Fig. 2   |
|                              | 18 Rubber Dam Clamp Fig. 2A  |
|                              | 19 Rubber Dam Clamp Fig. 7   |

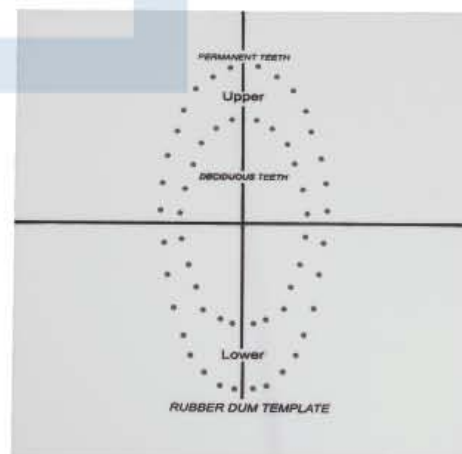

**SAR-1488**  
Rubber Dum Template

## RUBBER DAM CLAMPS

- Кляммера для коффердама
- Crampons pour digue
- Kofferdam Klammern
- Кляммера для коффердама
- Grapas para dique de caucho
- المشابك السد المطاط



SAR-1489  
Fig. 15



SAR-1490  
Fig. 18



SAR-1491  
Fig. 24



SAR-1492  
Fig. 25



SAR-1493  
Fig. 26



SAR-1494  
Fig. 28



SAR-1495  
Fig. 30



SAR-1496  
Fig. 31



SAR-1497  
Fig. 51



SAR-1498  
Fig. 138



SAR-1499  
Fig. 139



SAR-1500  
Fig. 200



SAR-1501  
Fig. 201



SAR-1502  
Fig. 202



SAR-1503  
Fig. 203



SAR-1504  
Fig. 204



SAR-1505  
Fig. 205



SAR-1506  
Fig. 3



SAR-1507  
Fig. W3



SAR-1508  
Fig. 4



SAR-1509  
Fig. 56A



SAR-1510  
Fig. 7



SAR-1511  
Fig. 7A



SAR-1512  
Fig. 8



SAR-1513  
Fig. 8A



SAR-1514  
Fig. W8A



SAR-1515  
Fig. 10



SAR-1516  
Fig. 11



SAR-1517  
Fig. 12A



SAR-1518  
Fig. 13A



SAR-1519  
Fig. 14



SAR-1520  
Fig. 14A



SAR-1521  
Fig. 14AN



SAR-1522  
Fig. 22



SAR-1523  
Fig. 27



SAR-1524  
Fig. 207



SAR-1525  
Fig. 29



SAR-1526  
Fig. 206



SAR-1527  
Fig. 208



SAR-1528  
Fig. 209



SAR-1529  
Fig. 1



SAR-1530  
Fig. 1A



SAR-1531  
Fig. 2



SAR-1532  
Fig. 2A



SAR-1533  
Fig. W2A



SAR-1534  
Fig. 0



SAR-1535  
Fig. 00



SAR-1536  
Fig. 210



SAR-1537  
Fig. 211



SAR-1538  
Fig. 212



SAR-1539  
Fig. 6



SAR-1540  
Fig. 9



SAR-1541  
Fig. N06



SAR-1542  
Fig. U67



SAR-1543  
Fig. 214



SAR-1544  
Fig. P1



SAR-1545  
Fig. P2



SAR-1546  
Fig. G-1



SAR-1547  
Fig. G-2



# CROWN REMOVER

- Инструменты для удаления коронок
- Arrache-couronnes
- Teleskopkronenzangen
- Инструменти для видалення коронок
- Arranca-corona
- مزيلات القماح



**SAR-1548**  
Crown Spreaders



**SAR-1550**  
Universal  
Fig. 0



**SAR-1552** **SAR-1553**



**SAR-1556** **SAR-1557**



**SAR-1559**  
Manual Crown  
Remover

Manual Crown Removers  
Handle with 3 tips **SAR-1551**  
Only 3 tips **SAR-1552 to SAR-1554**

Manual Crown Removers  
Handle with 3 tips **SAR-1555**  
Only 3 tips **SAR-1556 to SAR-1558**



**SAR-1560**  
Manual Crown Remover

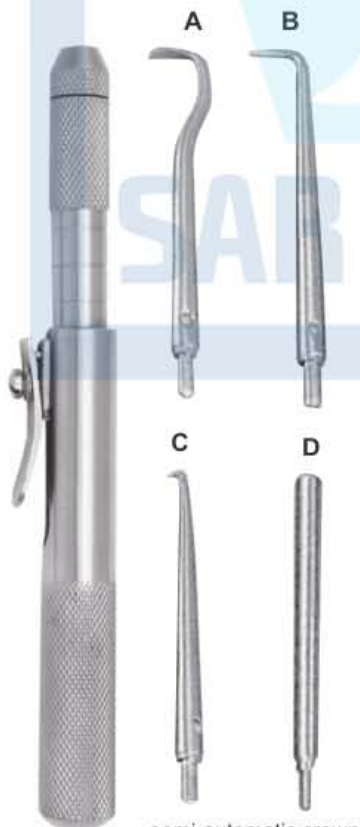

**SAR-1561**  
Complete with 3 tips  
and tightening keys

semi-automatic crown  
& bridge remover



**SAR-1562**

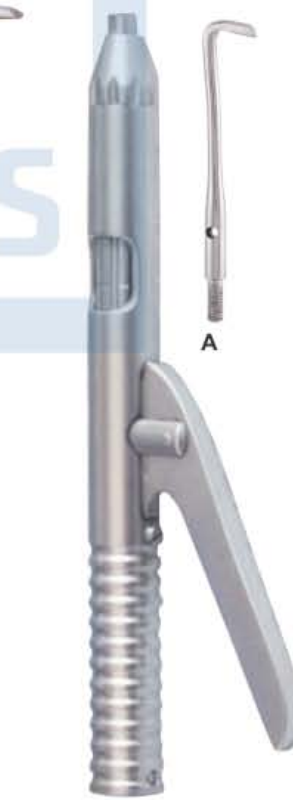

**SAR-1563**  
Manual Crown Remover

# MATRIX RETAINERS

- Матрицедержатели
  - Porte Matrices
  - Matrizenspanner
- Матрицеутримувачи
  - Porta Matrices
  - مصفوفة الخدم



**SAR-1564**  
Fig. 5  
Ivory 8  
5 cm



**SAR-1565**  
Fig. 6  
Ivory 8  
6 cm



**SAR-1566**  
Fig. 7  
Ivory 8  
7 cm



**SAR-1567**  
Fig. 1  
Tofflemire-Universal



**SAR-1568**



**SAR-1569**



**SAR-1570**



## Siqveland Retainers



**SAR-1571**  
Fig. 2  
Tofflemire-Junior



**SAR-1572**  
Fig. 3  
Tofflemire-Senior



**SAR-1573**  
Narrow



**SAR-1574**  
Wide

## Amalgam Well



**SAR-1575**  
Stainless Steel  
Amalgam Well



**SAR-1576**  
Ivory 12



**SAR-1577**  
Ivory 1



**SAR-1578**  
Ivory



**SAR-1579**  
Elliot

# AMALGAM INSTRUMENTS



- Инструменты для амальгамы
- Instruments pour amalgame
- Amalgamis/Instrumente
- Инструменти для амальгами
- Instrumentos para amalgama
- الصكوك المنغم



**SAR-1580**  
Fig. 10  
165mm  
English pattern



**SAR-1581**  
Fig. 1  
185mm  
German pattern



**SAR-1582**  
Fig. 1  
150mm  
Swiss pattern



**SAR-1583**  
Fig. 1  
150mm



**SAR-1584**  
Fig. 2  
150mm, 45°



**SAR-1585**  
Fig. 3  
140mm, 90°



**SAR-1586**  
Chip Blower



**SAR-1587**



**SAR-1588**



**SAR-1589**



**SAR-1590**  
Water Syringe

# AMALGAM INSTRUMENTS

- Инструменты для амальгамы
- Instruments pour amalgame
- Amalgamis/strumente
- Инструменты для амальгами
- Instrumentos para amalgama
- الصوك المنغم

## AMALGAM CARRIERS

### TIP SIZES FOR DISTAL OR SINGLE-END

1.5 mm



**SAR-1592**  
Mini/  
Single-End

2.0 mm



**SAR-1593**  
Regular  
Single-End

2.8 mm



**SAR-1594**  
Large  
Single-End

1.5 mm



**SAR-1595**  
Mini  
Distal

2.0 mm



**SAR-1596**  
Regular  
Distal

### TIP SIZES FOR DOUBLE-END

1.5 mm



2.0 mm  
**SAR-1597**  
Mini/  
Regular

2.8 mm



2.0 mm  
**SAR-1598**  
Large/  
Regular

3.2 mm



2.0 mm  
**SAR-1599**  
Jumbo/  
Regular



**SAR-1600**  
Amalgam  
Well



**SAR-1591**  
Single-End

### TIP SIZES FOR DOUBLE-END

**SAR-1601** - 1.5mm-2.0mm    **SAR-1604** - 1.0mm-2mm  
**SAR-1602** - 2.0mm-2.8mm    **SAR-1605** - 2.0mm-3mm  
**SAR-1603** - 2.0mm-3.2mm    **SAR-1606** - 2.0mm-4mm

**SAR-1607** - 1.5mm-2.0mm    **SAR-1610** - 1.0mm-2mm  
**SAR-1608** - 2.0mm-2.8mm    **SAR-1611** - 2.0mm-3mm  
**SAR-1609** - 2.0mm-3.2mm    **SAR-1612** - 2.0mm-4mm

**SAR-1613** - 1.5mm-2.0mm    **SAR-1616** - 1.0mm-2mm  
**SAR-1614** - 2.0mm-2.8mm    **SAR-1617** - 2.0mm-3mm  
**SAR-1615** - 2.0mm-3.2mm    **SAR-1618** - 2.0mm-4mm

**SAR-1619** - 1.5mm-2.0mm    **SAR-1622** - 1.0mm-2mm  
**SAR-1620** - 2.0mm-2.8mm    **SAR-1623** - 2.0mm-3mm  
**SAR-1621** - 2.0mm-3.2mm    **SAR-1624** - 2.0mm-4mm

**SAR-1625** - 1.5mm  
**SAR-1626** - 2.0mm  
**SAR-1627** - 2.0mm  
**SAR-1628** - 3.0mm



# CHISELES, BONE FILES & SPOONE CURETTE



## ROOT PLANNING FILES



**SAR-1641**  
Krarner-Ne vins  
Bone Chisel



**SAR-1642**  
Krarner-Ne vins  
Bone Chisel



**SAR-1643**  
Molt 18.5cm  
Auto Clavable  
Plastic Tips.

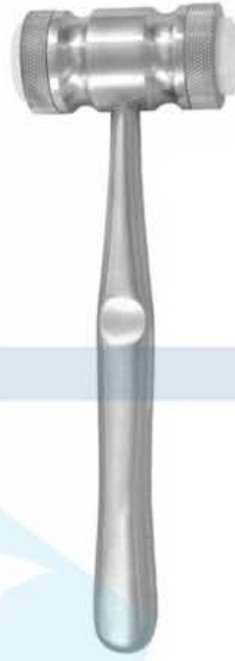

**SAR-1644**  
Mead 18.5cm  
Non Auto Clavable  
Plastic Tips.



**SAR-1645**  
Miller



**SAR-1646**  
Miller

## BONE FILES



**SAR-1647**  
Miller 21



**SAR-1648**  
Miller 1X  
cross cut



**SAR-1649**  
Miller 2X  
cross cut



**SAR-1650**  
Miller 52



**SAR-1651**  
Wahl 1

# PERIODONTAL INSTRUMENTS



- Инструменты пародонтологические
- Instruments pour la parodontologie
- Instrumente für die Parodontologie
- Інструменти пародонтологічні
- Instrumentos para periodoncia
- الصكوك اللثة

## PERIOSTEEL ELEVATORS

**SAR-1652**  
Ohl 10

**SAR-1653**  
Howard 9H

**SAR-1654**  
Freer

**SAR-1655**  
Freer 15

**SAR-1656**  
Freer 16

**SAR-1657**  
10.0mm

**SAR-1658**  
6.4mm

**SAR-1659**  
3.0mm

**SAR-1658**  
Raspator, Raspatory  
Length 175 mm

**SAR-1660**  
4.0mm

**SAR-1661**  
5.0mm

**SAR-1662**  
7.0mm

**Partsch 140 mm**  
SAR-1663 3mm  
SAR-1664 4mm  
SAR-1665 5mm  
SAR-1666 6mm

**Partsch 170 mm**  
SAR-1667 3mm  
SAR-1668 4mm  
SAR-1669 5mm  
SAR-1670 6mm

**Partsch 140 mm**  
SAR-1671 3mm  
SAR-1672 4mm  
SAR-1673 5mm  
SAR-1674 6mm

**Partsch 170 mm**  
SAR-1675 3mm  
SAR-1676 4mm  
SAR-1677 5mm  
SAR-1678 6mm

**SAR-1660**  
**SAR-1661**  
**SAR-1662**  
Raspator, Williger  
Length 170 mm, different widths  
(4 mm, 5 mm or 7 mm)

## PERIODONTAL INSTRUMENTS

- Инструменты пародонтологические
- Instruments pour la parodontologie
- Instrumente für die Parodontologie
- Инструменти пародонтологічні
- Instrumentos para periodoncia
- الصكوك اللثة

To separate tissue tooth or bone. tp hold tissue away from surgical site.

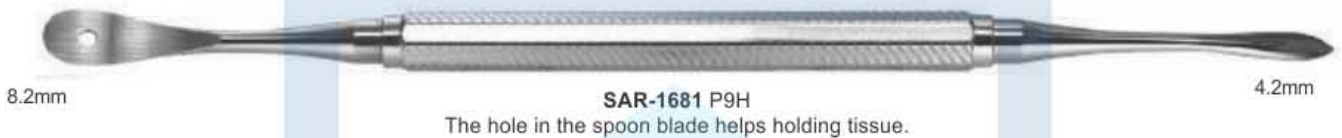



# PERIODONTAL INSTRUMENTS



- Инструменты пародонтологические
- Instruments pour la parodontologie
- Instrumente für die Parodontologie
- Інструменти пародонтологічні
- Instrumentos para periodoncia
- الصكوك اللثة



SAR-1689



SAR-1690  
P24G



SAR-1691  
titanium Periosteal Elevator for Implan5



SAR-1692  
S1



SAR-1693  
Hirschfeld



SAR-1694  
9S



10mm

SAR-1695  
Selden

13mm

4.8 mm



Prichard

10.6 mm

AF1

SAR-1696  
Friedmann



SAR-1697  
Schmidlin

6.9 mm

## SCALPEL HANDLES

- Ручки для скальпелей
- Manches de bistouris
- Skalpellgriffe
- Ручки для скальпелів
- Mangos de bisturi
- مشرط مقابض



**SAR-1698**  
Fig.3  
12.7cm



**SAR-1699**  
Fig.3G  
12.7cm



**SAR-1700**  
Fig.4  
13.7cm



**SAR-1701**  
Double Handle  
No.4 + No.3  
16.3cm



**SAR-1702**  
Fig. 7  
16.5cm



**SAR-1703**  
Scalpel Handle Straight  
for blades #10-15  
14.5cm



**SAR-1704**  
Micro Surgical Scalpel  
Handle titanium  
13.5cm



**SAR-1705**  
Fig. 5  
14.5cm



**SAR-1706**  
Fig. 5A  
14.5cm



**SAR-1707**  
6 Way Adjustable Angled  
Scalpel Handle

# MALLETS - PLASTER SHEARS - SAWS & BLADES



**SAR-1708**  
Metal tip  
220 mm  
Hammer With Wooden Handle



**SAR-1709**  
Metal tip  
220 mm



**SAR-1710**  
1  
For plaster



**SAR-1711**  
2  
For metal



**SAR-1712**  
Fret saw  
250 mm



**SAR-1713**  
Small  
Saw Blades



**SAR-1714**  
Large  
Saw Blades



**SAR-1715**  
Ceri Saw



Special Inox  
**SAR-1716** 170mm  
**SAR-1717** 200mm



**SAR-1718**  
Plaster Shears  
200 mm



Crucible Tongs  
**SAR-1719** 250 mm  
**SAR-1720** 320 mm



**SAR-1721**  
Ceri Saw  
180 mm



**SAR-1722**  
Blade  
0,12x5 mm  
Conf. 12 pcs



**SAR-1723**  
Blade  
0,25x5 mm  
Conf. 12 pcs



**SAR-1724**  
Blade  
0,25x3 mm  
Conf. 12 pcs



Behind Every Smile is a Story

- QUALITY - ЯКІСТЬ
- PRECISION - ТОЧНІСТЬ
- ACCURACY - ПРАВИЛЬНІСТЬ
- DURABILITY - ЗНОСОСТІЙКІСТЬ



**STYLE A**

- Super-sharp diamond-bonded cutters
- smooth ultra-polished and contoured edges
- brilliant corrosion resistant stainless steel finish
- superior T-12 stainless steel tool inserts
- sliding lock joint for balance & precise alignment

**STYLE B**

- Super-sharp diamond-bonded cutters
- smooth ultra-polished and contoured edges
- brilliant corrosion resistant stainless steel finish
- superior T-12 stainless steel tool inserts
- sliding lock joint for balance & precise alignment

# ORTHODONTIC INSTRUMENTS



- Инструменты ортодонтические
- Instrumentos Ortodonticos
- Orthodontische Instrumente
- Инструменти ортодонтични
- Instruments Orthodontiques
- أدوات تقويم الأسنان



**SAR-1800**  
Height Gauge 0.18  
Aluminum



**SAR-1801**  
Height Gauge 0.22  
Aluminum



**SAR-1802**  
Height Gauge 0.18  
Stainless Steel



**SAR-1803**  
Height Gauge 0.22  
Stainless Steel



**SAR-1804**  
Moveable  
Height Gauge



**SAR-1805**  
Endo Finger  
Ruler Span  
Measure Scale



**SAR-1806**  
Endo Finger  
Ruler Span  
Measure Scale



**SAR-1807**  
Endo Finger  
Ruler Span  
Measure Scale



**SAR-1808**  
Positive  
Postioner



**SAR-1809**  
Strip Saw



**SAR-1810**  
Bone Bracket Gauge



**SAR-1811**  
Endo Finger Ruler  
Span Measure Scale



**SAR-1812**  
Endo Finger Ruler  
Span Measure Scale

## ORTHODONTIC INSTRUMENTS

- Инструменты ортодонтические
- Instrumentos Ortodonticos
- Orthodontische Instrumente
- Инструменти ортодонтични
- Instruments Orthodontiques
- أدوات تقويم الأسنان



**SAR-1813**  
Measuring Loop  
angled, length  
175 mm,  
measuring range  
0 - 40 mm



**SAR-1814**  
Measuring Loop  
straight length  
175 mm,  
measuring range  
0 - 40 mm



**SAR-1815**  
Measuring loop, Castroviejo  
angled, length 175 mm,  
measuring range 0 - 40 mm,  
with window



**SAR-1816**  
Measuring Loop  
straight length 90 mm,  
measuring range  
0 - 40 mm,  
**SAR-1817**  
Castroviejo Calipers  
20mm  
90mm



**SAR-1818**  
Measuring Loop  
angled, length 90 mm,  
measuring range  
0 - 40 mm,  
**SAR-1819**  
Castroviejo Calipers  
20mm, 45°  
90mm



**SAR-1820**  
Castroviejo Calipers  
20mm  
90mm



**SAR-1821**  
Fig. 1  
Iwanson  
spring caliper  
For metal and  
porcelain.



**SAR-1822**  
Fig. 2  
Iwanson  
spring caliper  
For wax.

# ORTHODONTIC INSTRUMENTS



- Инструменты ортодонтические
- Instrumentos Ortodonticos
- Orthodontische Instrumente
- Инструменти ортодонтични
- Instruments Orthodontiques
- أدوات تقويم الأسنان



**SAR-1823**  
Boley Gauge

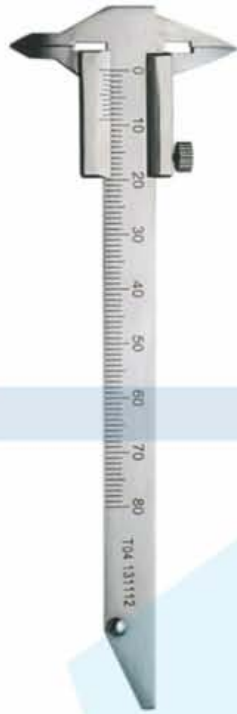

**SAR-1824**  
Vernier Gauge

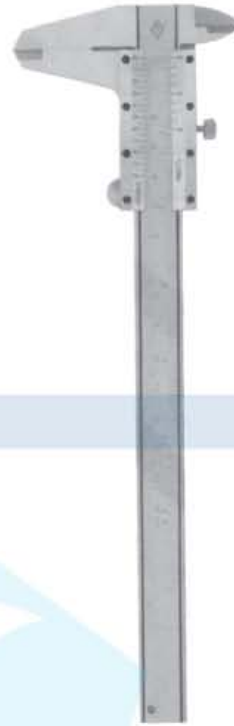

**SAR-1825**  
Aluminium Caliper  
up to 200mm



**SAR-1826**  
Boley Gauge



**SAR-1827**  
Delux Boley  
Gauge

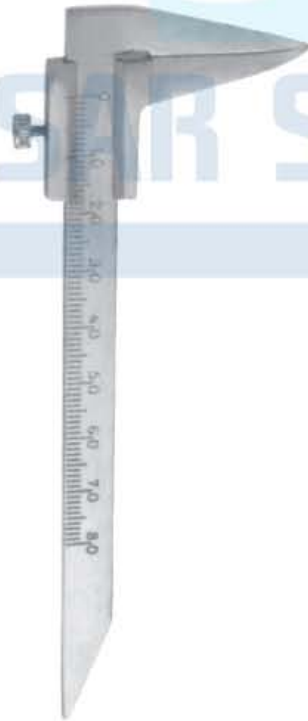

**SAR-1828**  
Beerendonk  
130mm  
Mini Gauge



**SAR-1829**  
Compasso  
De Willis



**SAR-1830**  
Dentaurum  
Ruler



**SAR-1831**  
Ruler Wedge



**SAR-1832**  
Ruler

## ORTHODONTIC INSTRUMENTS

- Инструменты ортодонтические
- Instrumentos Ortodonticos
- Orthodontische Instrumente
- Инструменти ортодонтични
- Instruments Orthodontiques
- أدوات تقويم الأسنان

### Bracket Holder Tweezers



**SAR-1833**  
Deluxe Bracket  
Holder Tweezers



**SAR-1834**  
Deluxe Bracket  
Holder Tweezers



**SAR-1835**  
Direct Bond Bracket  
Holder Tweezers



**SAR-1836**  
Bracket Tweezers  
Slot Aligner



**SAR-1837**  
Direct Bond  
Bracket Holder  
Tweezers, Small Tip



**SAR-1838**  
Exact Bracket  
Holder Tweezers



**SAR-1839**  
Bracket Placing  
Tweezers



**SAR-1840**  
Easy Access  
Tweezers



**SAR-1841**  
Bracket Placer  
Tweezers  
(Extra Fine Tip)



**SAR-1842**  
Deluxe Bracket  
Holder Tweezers  
135mm



**SAR-1843**  
Easy Eccess  
Tweezers



**SAR-1844**  
Slipper  
Tweezers



**SAR-1845**  
Direct Bonding  
Bracket Holders  
135mm



**SAR-1846**  
Direct Bonding  
Bracket Holders  
136mm



**SAR-1847**  
Direct Bonding  
Bracket Holders  
135mm



**SAR-1848**  
Deluxe Bracket  
Holder



**SAR-1849**  
Direct Bonding  
Bracket Holders  
140mm



# ORTHODONTIC INSTRUMENTS



- Инструменты ортодонтические
- Instrumentos Ortodonticos
- Orthodontische Instrumente
- Инструменти ортодонтични
- Instruments Orthodontiques
- أدوات تقويم الأسنان



**SAR-1850**  
Band seater  
auto cleavable



**SAR-1851**  
Band seater  
auto cleavable  
Triangle Shape



**SAR-1852**  
Band seater  
auto cleavable  
Square Shape



**SAR-1853**  
Band seater  
auto cleavable  
Round Shape



**SAR-1854**  
Mershon Band  
Pusher  
140mm



**SAR-1855**  
Band seating &  
removing  
instruments



**SAR-1856**  
Ortho Light double  
ended  
ligature director  
scaler



**SAR-1857**  
Ortho Light Band  
Pusher Scaler



**SAR-1858**  
Band Seating &  
Removing  
Silicon Grip



**SAR-1859**  
Ligature Instrument  
Silicon Grip



**SAR-1860**  
Elastic Instrument  
Silicon Grip



**SAR-1861**  
Distal Bender  
Silicon Grip



**SAR-1862**  
Distal Bender  
Silicon Grip



**SAR-1863**  
Distal Bender  
Silicon Grip

## ORTHODONTIC INSTRUMENTS

- Инструменты ортодонтические
- Instrumentos Ortodonticos
- Orthodontische Instrumente
- Инструменти ортодонтични
- Instruments Orthodontiques
- أدوات تقويم الأسنان



**SAR-1864**  
Ortho light scaler double ended



**SAR-1865**  
Ortho light scaler double ended



**SAR-1866**  
Ortho light scaler double ended



**SAR-1867**  
Twiel-on elastic module instrument



**SAR-1868**  
Twiel-on elastic module instrument



**SAR-1869**  
Schure Band Seater



**SAR-1870**  
Ortho light scaler



**SAR-1871**  
Ortho light scaler



**SAR-1872**  
Ortho light scaler heavy



**SAR-1873**  
Ortho instrument



**SAR-1874**  
Ortho instrument

# ORTHODONTIC INSTRUMENTS



- Инструменты ортодонтические
- Instrumentos Ortodonticos
- Orthodontische Instrumente
- Инструменти ортодонтични
- Instruments Orthodontiques
- أدوات تقويم الأسنان



**SAR-1875**  
Ortho Light double ended  
ligature director



**SAR-1876**  
Ortho Light double ended ligature scaler director tivate coil spring  
are remove modules with one instruments



**SAR-1877**  
Ortho band pusher scaler



**SAR-1878**  
Ortho ligature director single ended



**SAR-1879**  
Ortho Light double ended ligature  
director scaler



**SAR-1880**  
Ortho Light double ended ligature scaler/director  
tivate coil spring are remove modules with one instruments



**SAR-1881**  
Ortho Light double ended ligature director



**SAR-1882**  
Ortholite Ligature Director Scaler



**SAR-1883**  
Ortho light ligature director double ended



**SAR-1884**  
Double ended cement spatula



**SAR-1885**  
Ortho light scaler single ended

## PLIERS FOR ORTHODONTICS & PROSTHETICS

- Щипцы для ортодонтии и протезирования
- Pincers pour l'orthodontie et la prothèse
- Zangen für Kieferorthopädie und Prothetik
- Щипці для ортодонції та протезування
- Alicates para ortodoncia y prótesis
- كمشة لتقويم الأسنان بروستھتیس

### BOX JOINT PLIERS

**SAR-1886**  
Universal Dolphin Style  
Wire Bending & cutting pliers



**SAR-1892**  
Bracket Removing Plier curved  
Bracket Removing Plier curved for  
easy removal of brackets in the  
posterior region. Length 130mm



**SAR-1887 Band Removing Plier**  
The curved blade of the band  
removing plier can strip easily  
and gently remove directly to  
the tooth. Length 130mm



**SAR-1893**  
Young Wire Bending &  
Loop Forming Pliers



**SAR-1888**  
Tweed Loop  
forming Pliers



**SAR-1894**  
Wire Bending &  
Loop Forming Pliers



**SAR-1889**  
How Plier curved  
Universally usable tool for  
the multiband technology for  
wires up to .028".  
Length 130mm



**SAR-1895**  
Adams, small wire bending  
and loop forming Pliers



**SAR-1890 How Plier**  
Universally usable tool for the  
multiband technology for wires  
up to .028".  
Length 135mm



**SAR-1896**  
Bracket Removing Plier Round Box  
Bracket removing plier for comfortable  
and quick removal of the brackets.  
Length 135mm



**SAR-1891**  
Nance Loop  
forming Pliers



**SAR-1897**  
Weingart Plier medium  
Weingart plier that are ideal due to  
their curved tip for setting sheets and  
is capable of bending the ends.  
Length 145mm



# PLIERS FOR ORTHODONTICS & PROSTHETICS



- Щипцы для ортодонтии и протезирования
- Пинцес pour l'orthodontie et la prothèse
- Zangen für Kieferorthopädie und Prothetik
- Щипці для ортодонції та протезування
- Alicates para ortodoncia y prótesis
- كمشة لتقويم الأسنان بروسثیتس

## BOX JOINT PLIERS

**SAR-1898 Adams Plier Round Box**  
Adams pliers for bending wire arches and bends right angles for wires up to .022", .025 tip to beak. Length 125mm

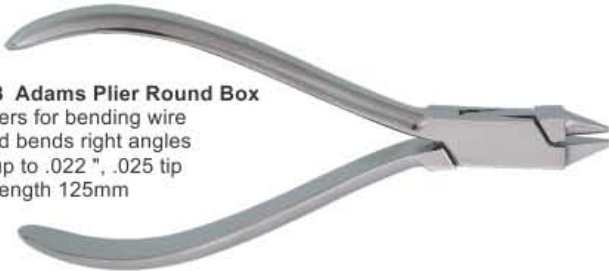

**SAR-1904 Adams Plier**  
Adams pliers for bending wire arches and bends right angles for wires up to .022", .025 tip to beak. Length 125mm



**SAR-1899 Falcon Beak Contouring Pliers.**



**SAR-1905 Tweed Loop Formin Pliers**



**SAR-1900**  
wires up to 0.020" / 0.7mm.



**SAR-1906 Bird Beak Plier Standard**  
Bird Beak Wire bending plier without notches, which is suitable as a universal utility tool. Length 125mm



**SAR-1901 Johnson Contouring Pliers**



**SAR-1907 Mini Ligature cutters**



**SAR-1902 Aderer Large wire bending and loop forming pliers**



**SAR-1908 Small Fluch-cut distal and cutting Pliers**  
with safety hold fitted with un-breakable, corrosion resistant and durable stainless steel tips



**SAR-1903 Tweed / angle rectangular arch forming & Torquing pliers**



**SAR-1909 Large Fluch-cut distal and cutting Pliers**  
with safety hold fitted with un-breakable, corrosion resistant and durable stainless steel tips



## PLIERS FOR ORTHODONTICS & PROSTHETICS

- Щипцы для ортодонтии и протезирования
- Pincers pour l'orthodontie et la prothèse
- Zangen für Kieferorthopädie und Prothetik
- Щипці для ортодонції та протезування
- Alicates para ortodoncia y prótesis
- كمشة لتقويم الأسنان بروستھتیس

### BOX JOINT PLIERS

#### SAR-1910

##### Tweed / Angel

1.78mm (.070") wide tips arch forming and torquing pliers



#### SAR-1916

##### Contouring Plier



#### SAR-1911

##### Tweed / Angel

1.78mm (.070") wide tips arch forming and torquing pliers

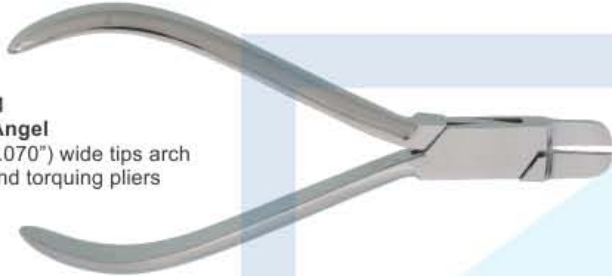

#### SAR-1917

##### Bands & Crowns Plier in order to skirt



#### SAR-1912

##### Lingual / Palatal arch forming pliers



#### SAR-1918

##### Ligature Forming Pliers



#### SAR-1913

##### Aderer

Facebow loop forming Pliers



#### SAR-1919

for double back and triple back bands in 0.30" / 0.76mm & 0.36" / 0.91mm lingual arch wires



#### SAR-1914

Waldsavhs wire bending and cutting pliers



#### SAR-1920

Bird Beak Wire Bending & cutting pliers



#### SAR-1915 Aderer Plier

For the manufacturing of appliances and activation of wires for wires up to .030" .fine tip and up to .036" mean tip. Length 130mm



#### SAR-1921

##### Weingart Plier medium

Weingart plier that are ideal due to their curved tip for setting sheets and is capable of bending the ends. Length 145mm



# PLIERS FOR ORTHODONTICS & PROSTHETICS



- Щипцы для ортодонтии и протезирования
- Пинцес pour l'orthodontie et la prothèse
- Zangen für Kieferorthopädie und Prothetik
- Щипці для ортодонції та протезування
- Alicates para ortodoncia y prótesis
- كمشة لتقويم الأسنان بروسثیتیس

## L-KEY JOINT PLIERS



**SAR-1922**  
Distal end cutter with safety hold, mini head, long handles.  
fitted with un-breakable, corrosion resistant and durable stainless steel tips

- 0.30 mm to 0.50 mm (.012" to .020")
- Max. 0.46 mm x 0.64 mm (.018" x .025")
- ⊗ 0.38 mm to 0.53 mm (.0155" to .0215")
- ⊗ Max. 0.53 mm x 0.64 mm (.021" x .025")



**SAR-1926**  
Soft wire and ligature cutter, 15° angled fitted with un-breakable, corrosion resistant and durable stainless steel tips

- ☞ .25 mm to .38 mm (.010" to .015")



**SAR-1923**  
Flush-cut distal end cutter with safety hold fitted with un-breakable, corrosion resistant and durable stainless steel tips

- 0.30 mm to 0.50 mm (.012" to .020")
- Max. 0.46 mm x 0.64 mm (.018" to .025")



**SAR-1927**  
Soft wire and ligature cutter, 45° angled fitted with un-breakable, corrosion resistant and durable stainless steel tips

- ☞ .25 mm to .38 mm (.010" to .015")



**SAR-1924**  
Soft wire and ligature cutter, Mini fitted with un-breakable, corrosion resistant and durable stainless steel tips

- ☞ .25 mm to .38 mm (.010" to .015")



**SAR-1928**  
Hard wire cutter, straight Fitted with un-breakable, corrosion resistant and durable stainless steel tips

- 0.30 mm to 0.50 mm (.012" to .020")
- Max. 0.56 mm x 0.71 mm (.022" x .028")



**SAR-1925**  
Soft wire and ligature cutter, standard fitted with un-breakable, corrosion resistant and durable stainless steel tips

- ☞ .25 mm to .38 mm (.010" to .015")



**SAR-1929**  
Hard wire cutter, 15° angled Fitted with un-breakable, corrosion resistant and durable stainless steel tips

- 0.30 mm to 0.50 mm (.012" to .020")
- Max. 0.56 mm x 0.71 mm (.022" x .028")



**SAR-1930**  
Hard wire cutter, 15° angled Non-autoclavable

- 0.30 mm to 0.50 mm (.012" to .020")
- Max. 0.56 mm x 0.71 mm (.022" x .028")

## PLIERS FOR ORTHODONTICS & PROSTHETICS

- Щипцы для ортодонтии и протезирования
- Pincers pour l'orthodontie et la prothèse
- Zangen für Kieferorthopädie und Prothetik
- Щипці для ортодонції та протезування
- Alicates para ortodoncia y prótesis
- كمشة لتقويم الأسنان بروسشیتس

### L-KEY JOINT PLIERS



**SAR-1931**  
Band removing pliers



**SAR-1936**  
Weingart-mini  
Utility Pliers

- 0.30 mm to 0.50 mm (.012" to .020")
- Max 0.56 mm x 0.71 mm (.022" x .028")



**SAR-1932**  
Bracket removing pliers angled



**SAR-1937**  
Weingart  
Utility Pliers

- 0.30 mm to 0.50 mm (.012" to .020")
- Max 0.56 mm x 0.71 mm (.022" x .028")



**SAR-1933**  
Bracket removing pliers straight



**SAR-1938**  
How Straight  
Utility Pliers

- 0.30 mm to 0.50 mm (.012" to .020")
- Max 0.56 mm x 0.71 mm (.022" x .028")



**SAR-1934**  
Bracket removing pliers with plastic tip



**SAR-1939**  
Angled  
Utility Pliers

- 0.30 mm to 0.50 mm (.012" to .020")
- Max 0.56 mm x 0.71 mm (.022" x .028")



**SAR-1935**  
Adhesive removing pliers



**SAR-1940**  
Wire bending and loop forming pliers  
Angled (Bird beak)

- 0.30 mm to 0.50 mm (.012" to .020")
- Max 0.56 mm x 0.71 mm (.022" x .028")



# PLIERS FOR ORTHODONTICS & PROSTHETICS



- Щипцы для ортодонтии и протезирования
- Пинцес pour l'orthodontie et la prothèse
- Zangen für Kieferorthopädie und Prothetik
- Щипці для ортодонції та протезування
- Alicates para ortodoncia y prótesis
- كماشة لتقويم الأسنان بروستیتیس

## L-KEY JOINT PLIERS



**SAR-1941**  
Multi-purpose pliers, bird beak,  
De la rosa and cutter in one

- 0.30 mm to 0.50 mm (.012" to .020")
- Max. 0.46 mm x 0.56 mm (.018" x .022")



**SAR-1946**  
Stop pliers V-Bebd - 1mm

- 0.30 mm to 0.50 mm (.012" to .020")
- Max. 0.43 mm x 0.56 mm (.017" x .028")



**SAR-1942**  
Cinch Back / tie back  
Distal end bending pliers

- 0.30 mm to 0.50 mm (.012" to .020")
- Max. 0.56 mm x 0.71 mm (.022" x .028")



**SAR-1947**  
Lingual / palatal arch forming plies

- 0.76 mm (.030") / 0.91 mm (.036")



**SAR-1943**  
Hammer head  
Distal end bending pliers

- 0.30 mm to 0.50 mm (.012" to .020")
- Max. 0.56 mm x 0.71 mm (.022" x .028")



**SAR-1948**  
Torquing pliers set



**SAR-1944**  
Nance  
Loop forming pliers

- 0.36 mm to 0.71 mm (.014" to .028")
- Max. 0.56 mm x 0.71 mm (.022" x .028")



**SAR-1949**  
Tweed / angel  
Rectangular arch forming and  
torquing pliers

- 0.30 mm to 0.71 mm (.012" to .028")
- Max. 0.56 mm x 0.71 mm (.022" x .028")



**SAR-1945**  
Detailing step pliers / Bayonet  
bending pliers - 1mm

- 0.30 mm to 0.50 mm (.012" to .020")
- Max. 0.56 mm x 0.71 mm (.022" x .028")



**SAR-1950**  
Surgical ball hook crimping pliers,  
angled



**SAR-1951**  
Surgical ball hook crimping  
pliers, straight

## PLIERS FOR ORTHODONTICS & PROSTHETICS

- Щипцы для ортодонтии и протезирования
- Pincettes pour l'orthodontie et la prothèse
- Zangen für Kieferorthopädie und Prothetik
- Щипці для ортодонції та протезування
- Alicates para ortodoncia y prótesis
- كمشة لتقويم الأسنان بروستھتیس

### L-KEY JOINT PLIERS



**SAR-1952**  
Aderer Clamp three jaw wire bending plier for contouring and bending wire up to .30"/.76mm.

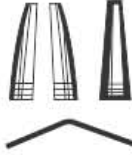

**SAR-1958**  
Falcon beak contouring plier.

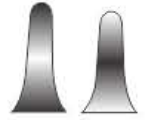

**SAR-1953**  
Bird beak plier for bending round, square and rectangle wire up to .30"/.76mm.

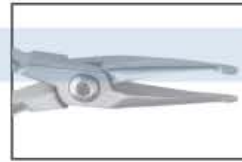
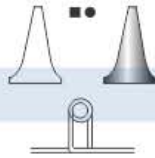

**SAR-1959**  
For placement and removal of arch wires, pins and other auxiliaries.



**SAR-1954**  
Bird beak plier for light wire bending round, square and rectangular up to .016"/0.41mm.

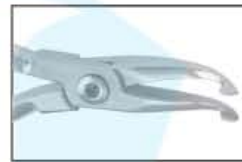
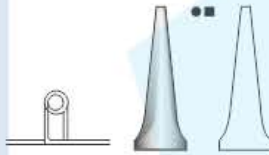

**SAR-1960**  
For placement and removal of arch wires, pins and other auxiliaries in angle design



**SAR-1955**  
Double Rounded jaw bending pliers, hooks and wire up to .020"/0.51mm.

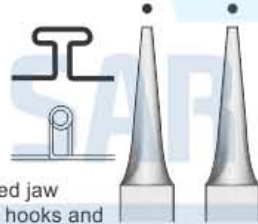

**SAR-1961**  
contouring Plier.

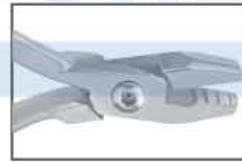

**SAR-1962**  
Bending plier. In order to skirt molars bands. With grooved. Recommended wire. 016", 018" and 022" 0.41mm, 0.46mm and 0.56mm



**SAR-1956**  
Adams pliers for hooks and bending wire up to .030"/0.76mm.

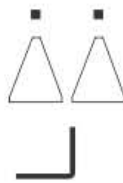

**SAR-1963**  
Loop forming in four length 3,4,5 & 6 mm wire capacity 0.22", 56mm.

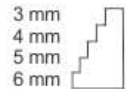

**SAR-1957**  
Johnson pliers for crown band contouring



**SAR-1964**  
Arch bending plier design for convenient handling of square or rectangular wire, .020" / 0.51mm.



# PLIERS FOR ORTHODONTICS & PROSTHETICS



- Щипцы для ортодонтии и протезирования
- Пинцес pour l'orthodontie et la prothèse
- Zangen für Kieferorthopädie und Prothetik
- Щипці для ортодонції та протезування
- Alicates para ortodoncia y prótesis
- كمانشة لتقويم الأسنان بروستhetics

## LAP & L-KEY JOINT PLIERS



**SAR-1965**  
In order to skirt bands and crowns.



**SAR-1966**  
Wires up to .020" / 0.7mm.

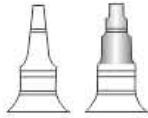

**SAR-1967**  
Round and concave plier for loop forming and banding wire up to .20" / .051mm.



**SAR-1968**  
Bending for round square or rectangular wire up to 0.30"/0.76mm



**SAR-1969**  
for double back and triple back bands in 0.30" / .76mm & 0.36" / .91mm lingual arch wires.



**SAR-1970**  
Detailing step plier double-sided offset beak permits bayonet bends. Creates right hand or left hand step-up or stepdown at 1/2, 3/4, or 1mm increments.

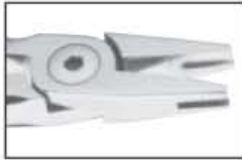

**SAR-1971**  
"V" bend stop special design makes 1mm "v" bends to shorten archwires or provide a positive stop. Excellent for placing stops in titanium wires. For round or rectangular wires up to .025"



**SAR-1972**  
Angle how plier efficient utility plier with serrated beaks for a firm grip. 45 angled tips to access hard to reach areas.



**SAR-1973**  
Weingardt plier serrated tips hold wires firmly at a convenient working angle. Tapered beaks fit easily between brackets and hard to reach areas. Our most popular utility plier.



**SAR-1974**  
Pin & Ligature Cutters TC.



**SAR-1975**  
Mini Pin & Ligature Cutter TC.



**SAR-1976**  
Standard Ligature Cutter TC.



**SAR-1977**  
V Bend Stop Plier TC.



**SAR-1978**  
Angled Direct Bond Bracket Remover TC.



**SAR-1979**  
Cutter Str.

Distal Cutter 14cm  
**SAR-1980** 2.5 mm  
**SAR-1981** 3.0 mm  
**SAR-1982** 3.0 mm

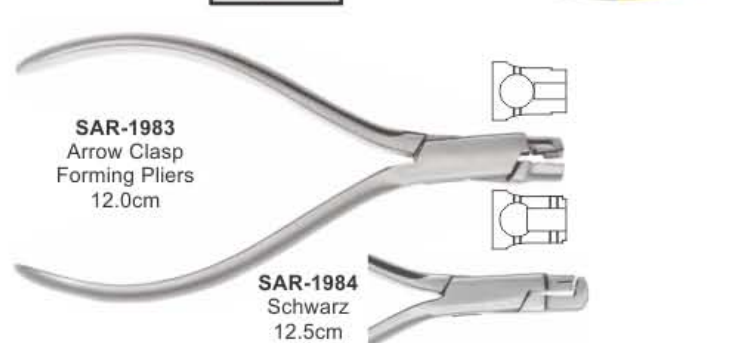

**SAR-1983**  
Arrow Clasp Forming Pliers 12.0cm

**SAR-1984**  
Schwarz 12.5cm



**SAR-1985**  
Distal end Cutter, Safety Hold Plier  
(Ideal for Cutting Wire) TC.



**SAR-1986**  
Hook Crimping Plier Angled  
Straight TC.



**SAR-1987**  
3 Prong Clasp Adjustable  
Plier TC.



**SAR-1988**  
Utility Plier Weingart TC.



**SAR-1989**  
Direct Bracket Remover  
TC.



**SAR-1990**  
Straight Direct Bond Bracket  
Remover TC.



**SAR-1991**  
Pin Holding Plier TC.



**SAR-1992**  
Hard wire cutters



**SAR-1993**  
Elastic Separating Plier  
Round Handle

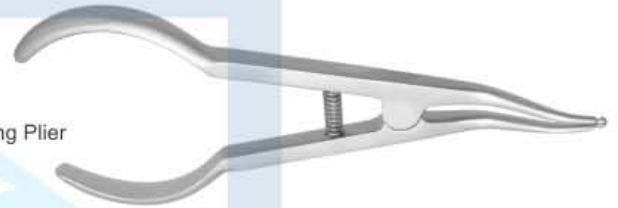

**SAR-1994**  
Elastic  
Separating Plier

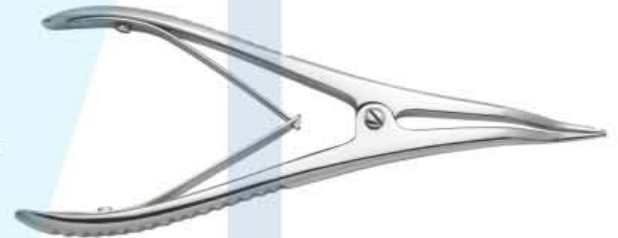

**SAR-1995** Str.  
**SAR-1996** Cvd.  
Smaha  
Elastomeric  
ligature  
placing forceps  
140 mm



**SAR-1997**  
Elastomeric  
ligature placing  
forceps with  
groove  
Falcon 140 mm



**SAR-1998**  
Elastomeric  
ligature placing  
forceps with  
groove  
Falcon 140 mm



# PLIERS FOR ORTHODONTICS & PROSTHETICS



- Щипцы для ортодонтии и протезирования
- Пинцес pour l'orthodontie et la prothèse
- Zangen für Kieferorthopädie und Prothetik
- Щипці для ортодонції та протезування
- Alicates para ortodoncia y prótesis
- كمشاة لتقويم الأسنان بروتستیس

## CUTTER, UTILITY PLIERS & WIRE FORMING PLIERS



**SAR-1999**  
Weingart Pliers



**SAR-2004**  
Adhesive  
Removing Pliers

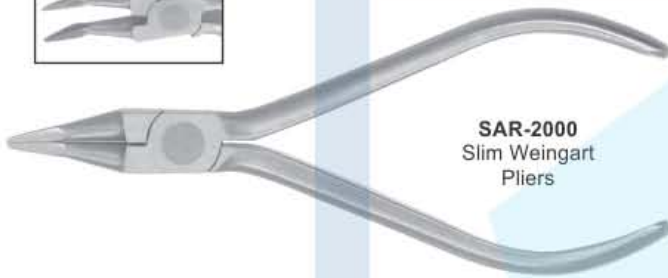

**SAR-2000**  
Slim Weingart  
Pliers

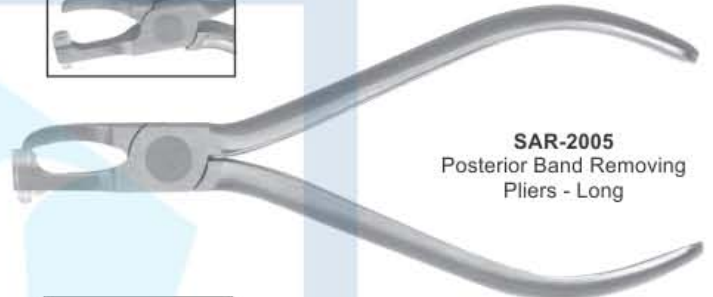

**SAR-2005**  
Posterior Band Removing  
Pliers - Long



**SAR-2001**  
How Pliers  
Straight



**SAR-2006**  
Posterior Band Removing  
Pliers - Short



**SAR-2002**  
How Pliers Offset

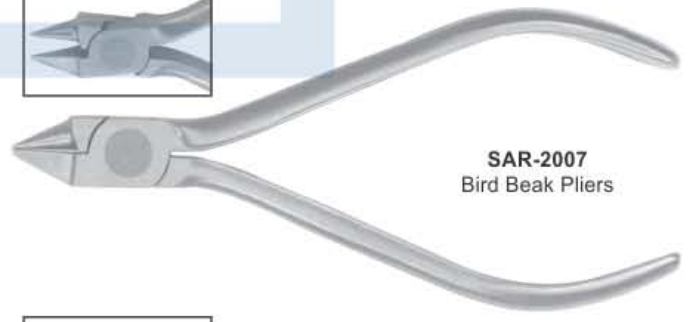

**SAR-2007**  
Bird Beak Pliers



**SAR-2003**  
Band seating Pliers

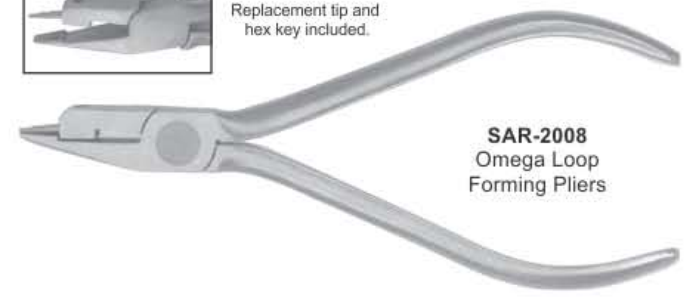

Replacement tip and  
hex key included.

**SAR-2008**  
Omega Loop  
Forming Pliers

- Щипцы для ортодонтии и протезирования
- Pincers pour l'orthodontie et la prothèse
- Zangen für Kieferorthopädie und Prothetik
- Щипці для ортодонції та протезування
- Alicates para ortodoncia y prótesis
- كمشة لتقويم الأسنان بروستھتیس

### CUTTERS



**SAR-2009**  
Hard  
Wire Cutter 15



**SAR-2013**  
Mini Pin &  
Ligature Cutter

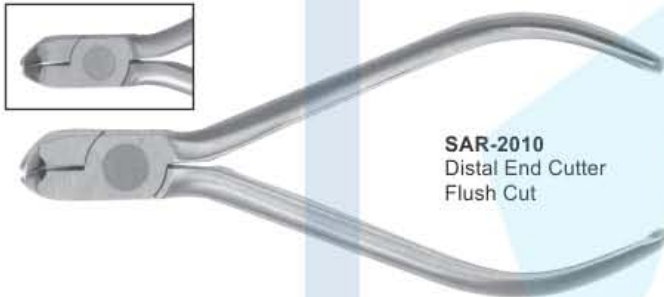

**SAR-2010**  
Distal End Cutter  
Flush Cut

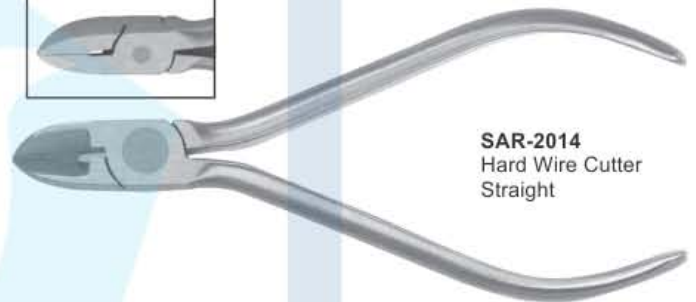

**SAR-2014**  
Hard Wire Cutter  
Straight



**SAR-2011**  
Universal Cut & Hold  
Distal End Cutter



**SAR-2015**  
Micro-Mini Pin &  
Ligature Cutter



**SAR-2012**  
Pin & Ligature  
Cutter



**SAR-2016**  
Cutter

## PLIERS FOR ORTHODONTICS & PROSTHETICS



- Щипцы для ортодонтии и протезирования
- Pincers pour l'orthodontie et la prothèse
- Zangen für Kieferorthopädie und Prothetik
- Щипці для ортодонції та протезування
- Alicates para ortodoncia y prótesis
- كمشة لتقويم الأسنان بروستیتیس



**SAR-2017**  
Three Jaw Pliers



**SAR-2021**  
Jarabak Pliers

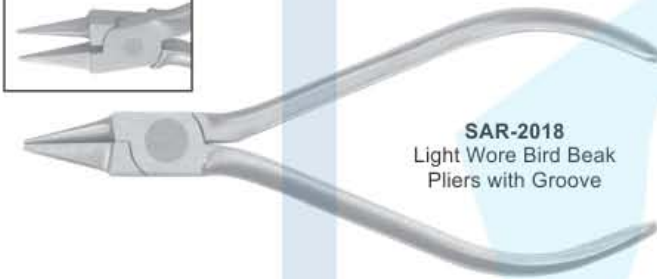

**SAR-2018**  
Light Wore Bird Beak  
Pliers with Groove

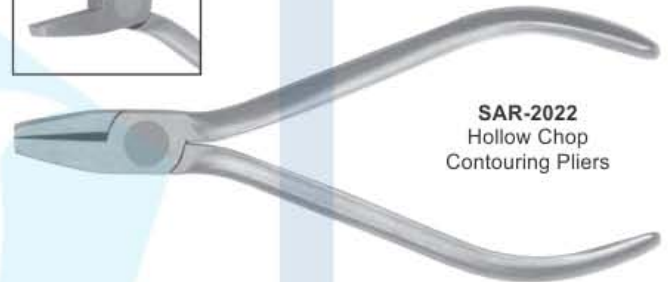

**SAR-2022**  
Hollow Chop  
Contouring Pliers



**SAR-2019**  
Tweed loop  
Forming Pliers



**SAR-2023**  
Lingual Arch  
Forming Pliers



**SAR-2020**  
Arch Bending Pliers



**SAR-2024**  
Rectangular Arch  
Bending Pliers

## ORTHODONTICS PLIERS STANDS

- Ортодонтия Щипцы Подставки
- Supports de pinces d'orthodontie
- Kieferorthopädie Zangenständer
- Ортодонтия Щипці Підставки
- KFO Zangen Ständer
- تقويم الأسنان كمشاة نطق



**SAR-2025**  
Plier Stand  
Stainless Steel.



**SAR-2026**  
Plier Stand  
Stainless Steel.



**SAR-2027**  
Pliers Stand  
Stainless Rod  
(Aluminum Anodized)  
Stainless Steel



**SAR-2028**  
Plier Stand  
Stainless Steel.



**SAR-2029**  
Plier Stand  
Stainless Steel.



**SAR-2030**  
Plier Stand  
Plastic



# Normal Anatomy – Dental Implants

Bone Level Normal  
(No Bone Loss)

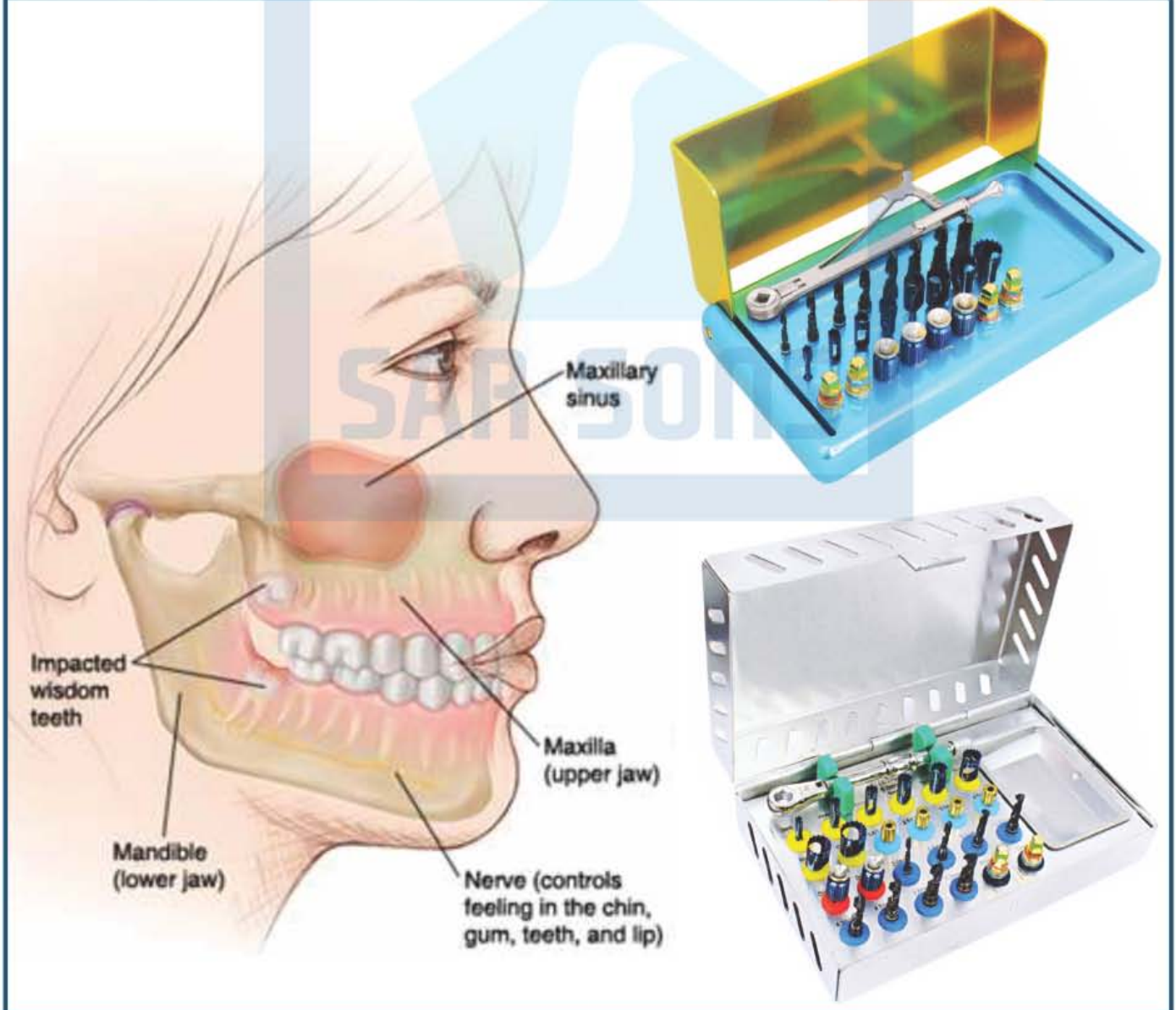
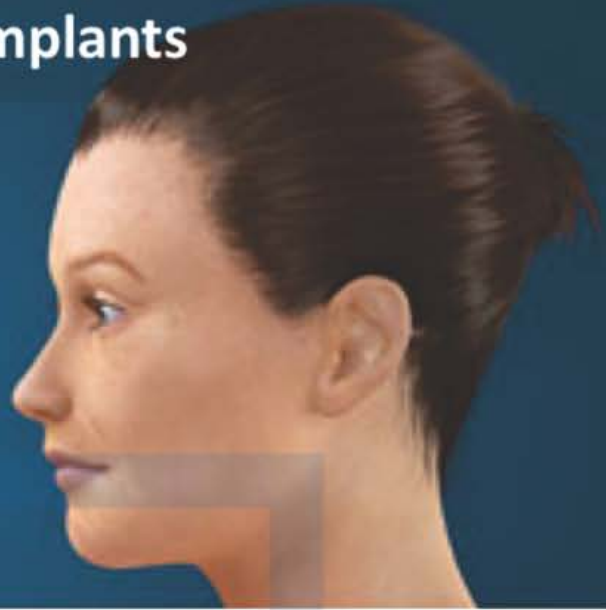

Maxillary sinus

Maxilla (upper jaw)

Mandible (lower jaw)

Impacted wisdom teeth

Nerve (controls feeling in the chin, gum, teeth, and lip)

- Инструменты для имплантологии
- Implantologie
- Implantologie
- Инструменти для імплантології
- Implantologia
- زراعة الأسنان

## IMPLANT GAGES



**SAR-2100**  
**Multifunctional Meter**  
 Length 90 mm,  
 different sizes,  
 8-10-11mm,  
 corrosion-resistant

**SAR-2101**  
**Multifunctional Meter**  
 Length 90 mm,  
 different sizes,  
 5-13-15-17 mm,  
 corrosion-resistant

**SAR-2102**  
**Measuring Probe**  
 Length 170 mm,  
 hand shape or flexible  
 (6-8-10-14-16 mm),  
 corrosion-resistant

**SAR-2103**

**SAR-2104**

**SAR-2105**

**SAR-2106**

## IMPLANT GAGES



**SAR-2107**

**SAR-2108**

**SAR-2109**

# IMPLANTOLOGY



- Инструменты для имплантологии
- Implantologie
- Implantologie

- Инструменти для імплантології
- Implantologia
- زراعة الأسنان



**SAR-2110**  
Ridge Mapping  
Double Caliper



**SAR-2111**  
Bone Thickness Gauge  
40mm, 180mm



**SAR-2112**  
Osteometer  
Measuring Forceps For Jaw  
Ridge Width measurement, scale  
on both sides, rustfree, autoclavie



**SAR-2113**  
Micro Boley  
Gauge Twisted



**SAR-2114**  
Micro Boley  
Gauge Straight



**SAR-2115**  
Ortho Ruler / Cone Socket

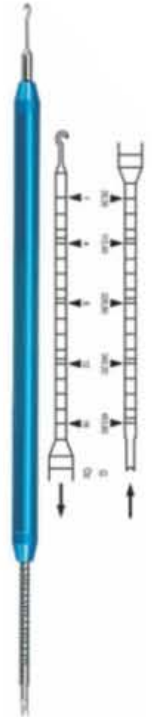

**SAR-2116**  
Dynamometer

- Инструменты для имплантологии
- Implantologie
- Implantologie
- Инструменти для імплантології
- Implantologia
- زراعة الأسنان

## BLACK TITANIUM COLOUR COATED INSTRUMENTS

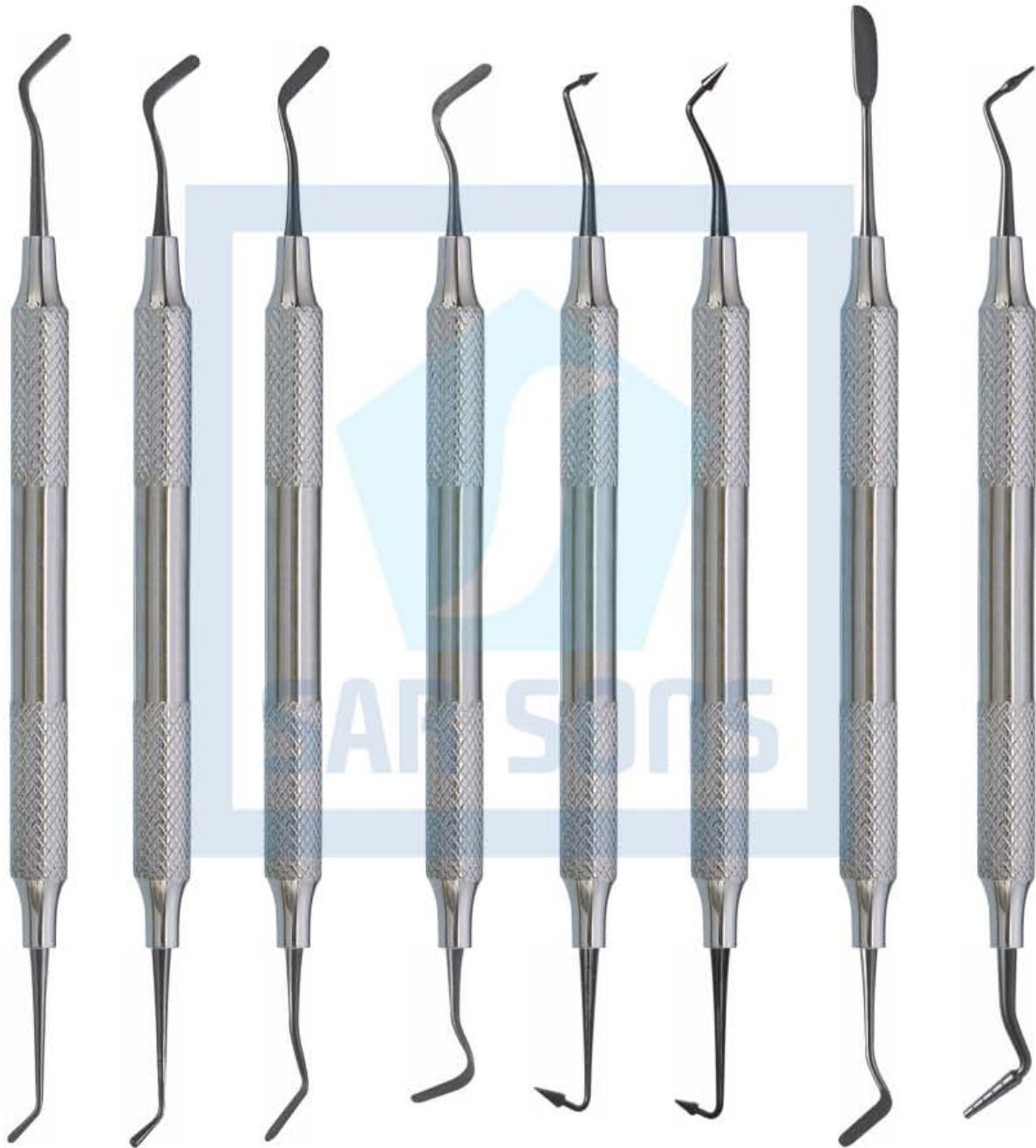

SAR-2117  
#1

SAR-2118  
#2

SAR-2119  
#3  
Extra-Flex

SAR-2120  
#4  
Extra-Flex

SAR-2121  
#5  
Flexi-Thin

SAR-2122  
#6  
Flexi-Thin

SAR-2123  
AB1  
Boghosian

SAR-2124  
AB2  
Boghosian

# IMPLANTOLOGY



- Инструменты для имплантологии
- Implantologie
- Implantologie
- Инструменти для імплантології
- Implantoloia
- زراعة الأسنان

## BLACK TITANIUM COLOUR COATED INSTRUMENTS

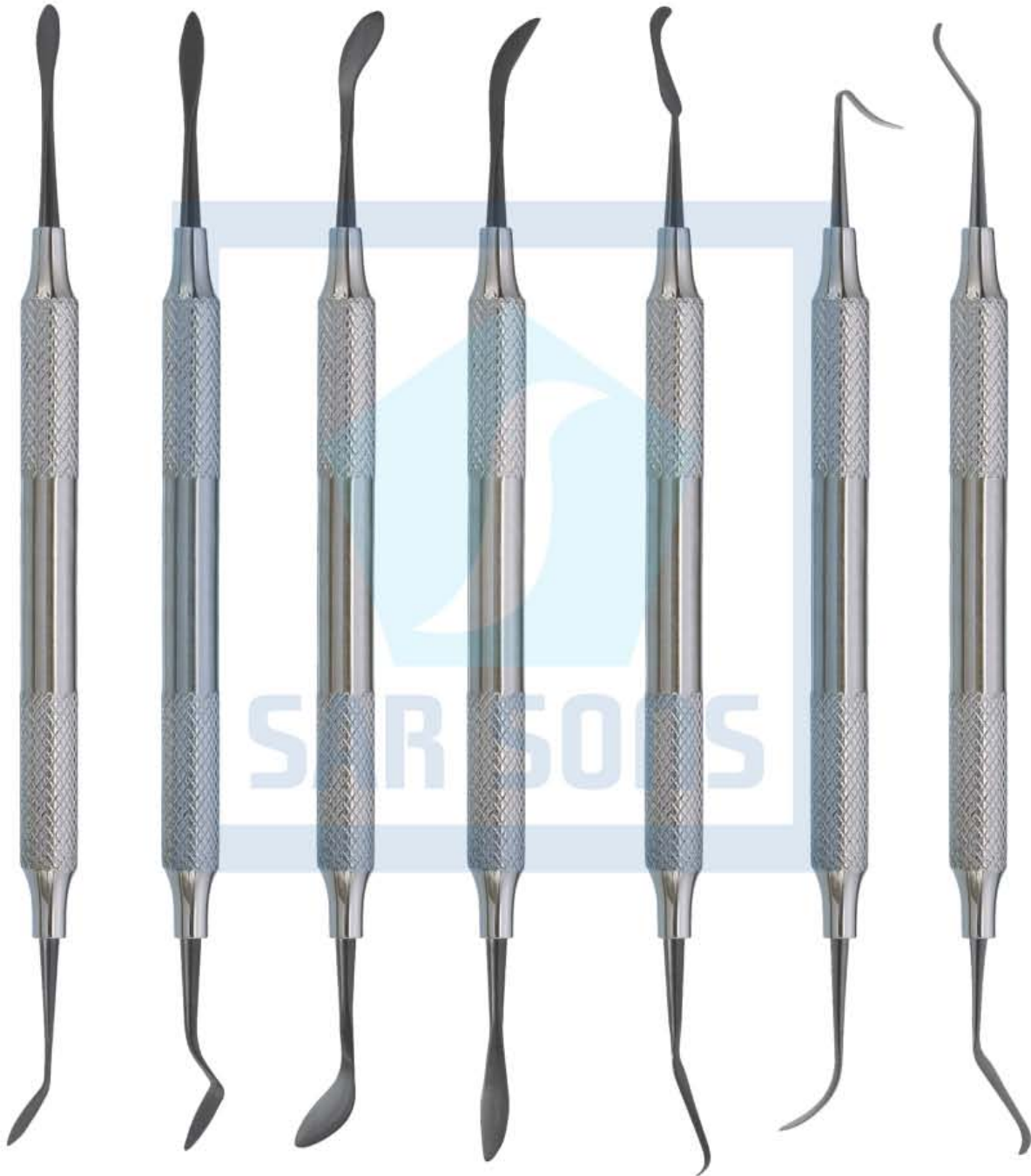

**SAR-2125**  
A  
Cosmetic  
Contouring

**SAR-2126**  
B  
Cosmetic  
Contouring

**SAR-2127**  
C  
Cosmetic  
Contouring

**SAR-2128**  
D  
Cosmetic  
Contouring

**SAR-2129**  
F  
Cosmetic  
Contouring

**SAR-2130**  
Marginal Ridge  
& Embrasure  
Shaping Instrument

**SAR-2131**  
Occlusal  
Anatomy  
Instrument

- Инструменты для имплантологии
- Implantologie
- Implantologie
- Инструменти для імплантології
- Implantologia
- زراعة الأسنان

## BLACK TITANIUM COLOUR COATED INSTRUMENTS

### BURNISHERS

### FREEDMAN BURNISHERS

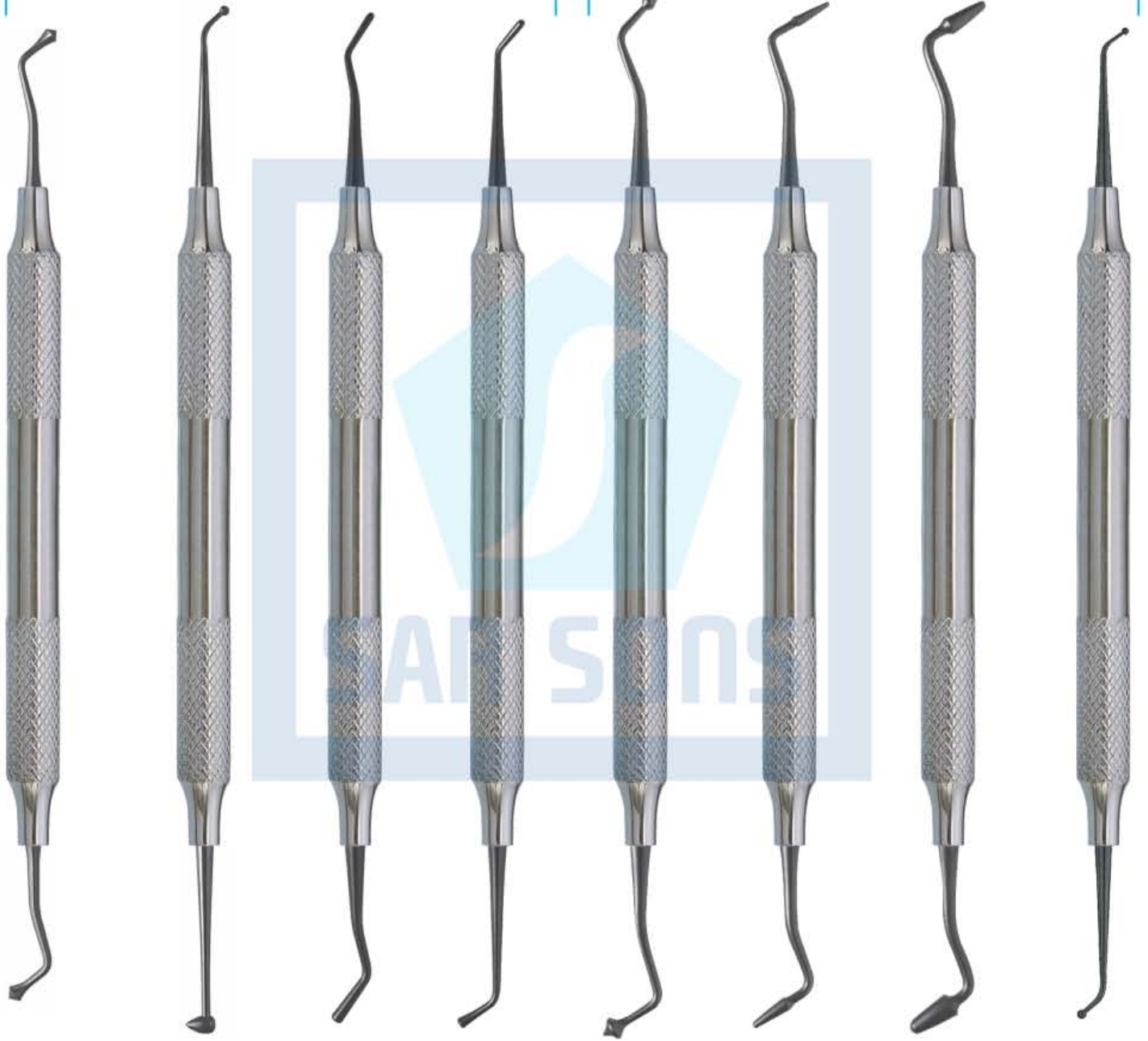

**SAR-2132**  
21B

**SAR-2133**  
27/29

**SAR-2134**  
2  
Ladmore

**SAR-2135**  
3  
Ladmore

**SAR-2136**  
Freedman  
"Duckhead"

**SAR-2137**  
Freedman  
Small Contact  
Forming

**SAR-2138**  
Freedman  
Large Contact  
Forming

**SAR-2139**  
Small/  
Medium Ball  
Burnisher

# IMPLANTOLOGY



- Инструменты для имплантологии
- Implantologie
- Implantologie
- Инструменти для імплантології
- Implantologia
- زراعة الأسنان

## SINUS LIFT INSTRUMENTS HOLLOW HANDLE 9.5MM LENGTH 170MM

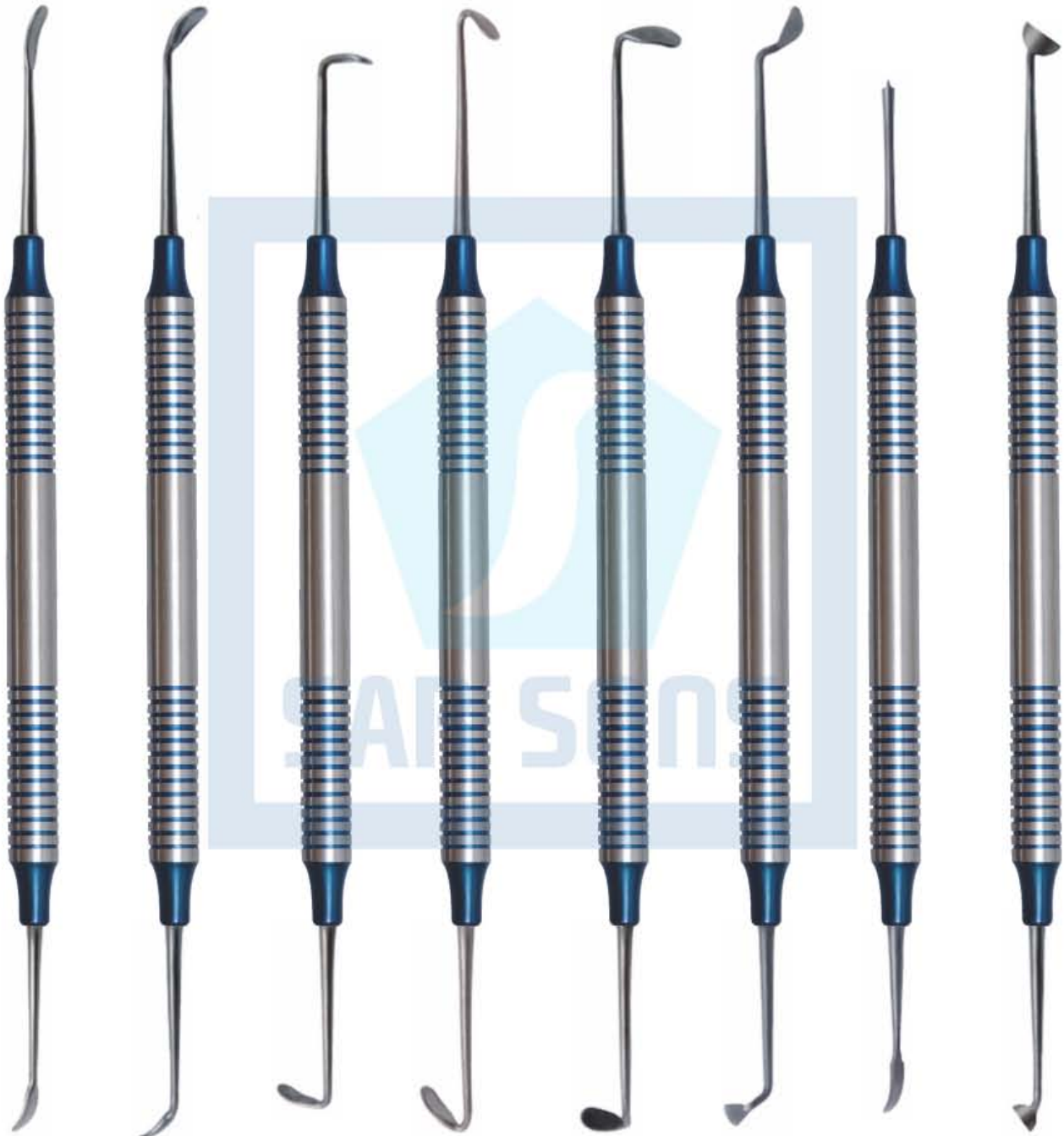

SAR-2140  
Sinuslift 1

SAR-2141  
Sinuslift 2

SAR-2142  
Sinuslift 3

SAR-2143  
Sinuslift 4

SAR-2144  
Sinuslift 5

SAR-2145  
Sinuslift 6

SAR-2146  
Membrane  
3Positioning 1

SAR-2147  
Condenser 1

# IMPLANTOLOGY

- Инструменты для имплантологии
  - Implantologie
  - Implantologie
- Инструменти для імплантології
  - Implantologia
  - زراعة الأسنان

**Sinus Lift Instrument,**  
Flexible Sinus Lift instruments  
reduce the risk of perforation of the  
"Schneider's membrane"

**Sinus Lift Elevator,**  
10 mm Straight grip  
Length 175 mm, Sinus lift elevators, dull,  
for gentle peeling and lifting the  
Schneider membrane

**Sinus lift instrument**  
10 mm Straight grip Length 180 mm,  
Buser (B1, B2, B3) raspatories,  
quality medical stainless steel,  
corrosion-resistant

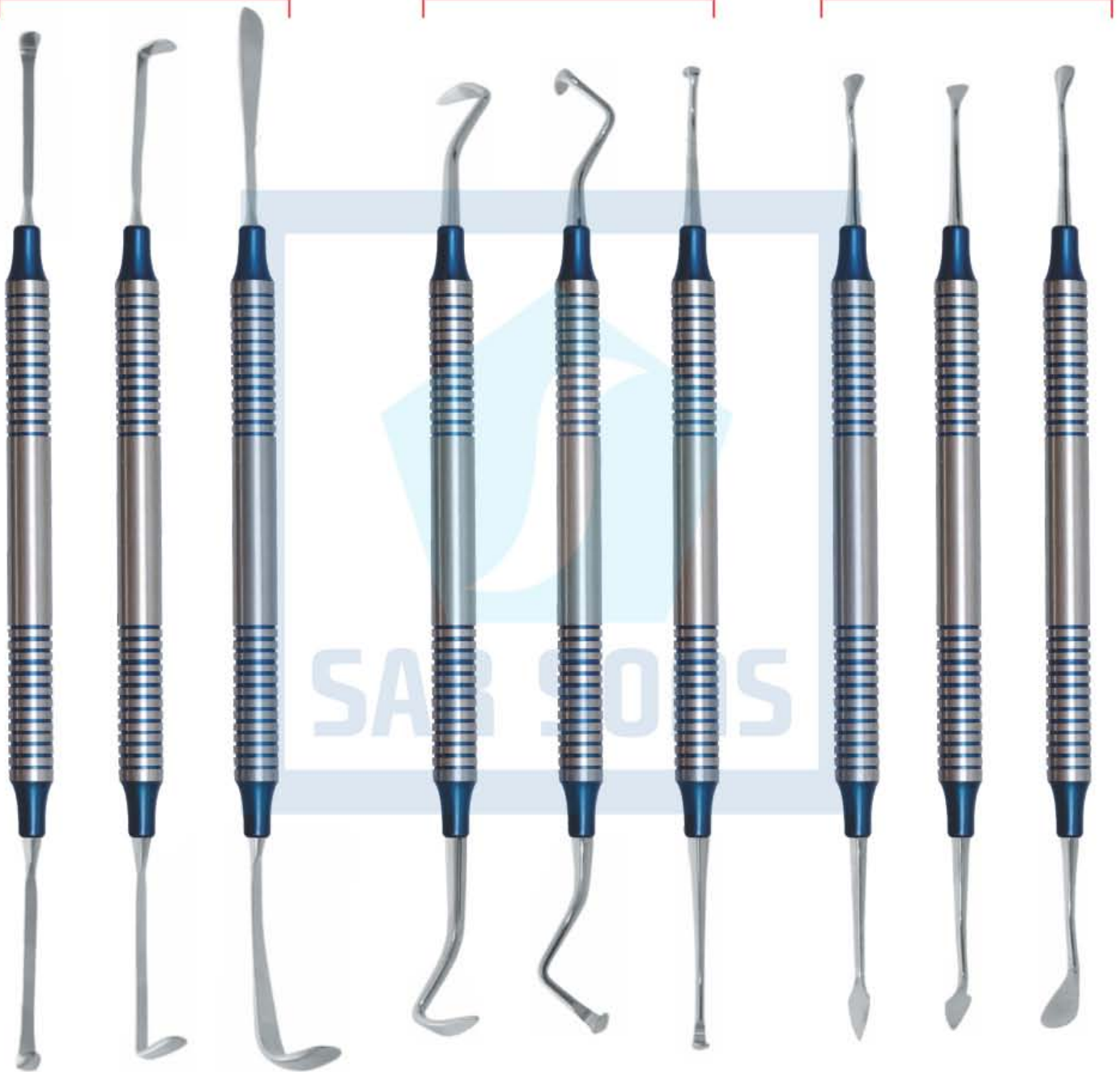

SAR-2148 Fig. 1 SAR-2149 Fig. 2

SAR-2150 Fig. 3

SAR-2151 Fig. 1

SAR-2152 Fig. 2

SAR-2153 Fig. 3

SAR-2154 B01

SAR-2155 B02

SAR-2156 B03



## IMPLANTOLOGY



- Инструменты для имплантологии
- Implantologie
- Implantologie
- Инструменти для імплантології
- Implantoloia
- زراعة الأسنان

**Sinus lift instrument** 10 mm Straight grip Sinus lift elevators, blunt or sharply curved (H01, H02, K03, K04, K78, K77)

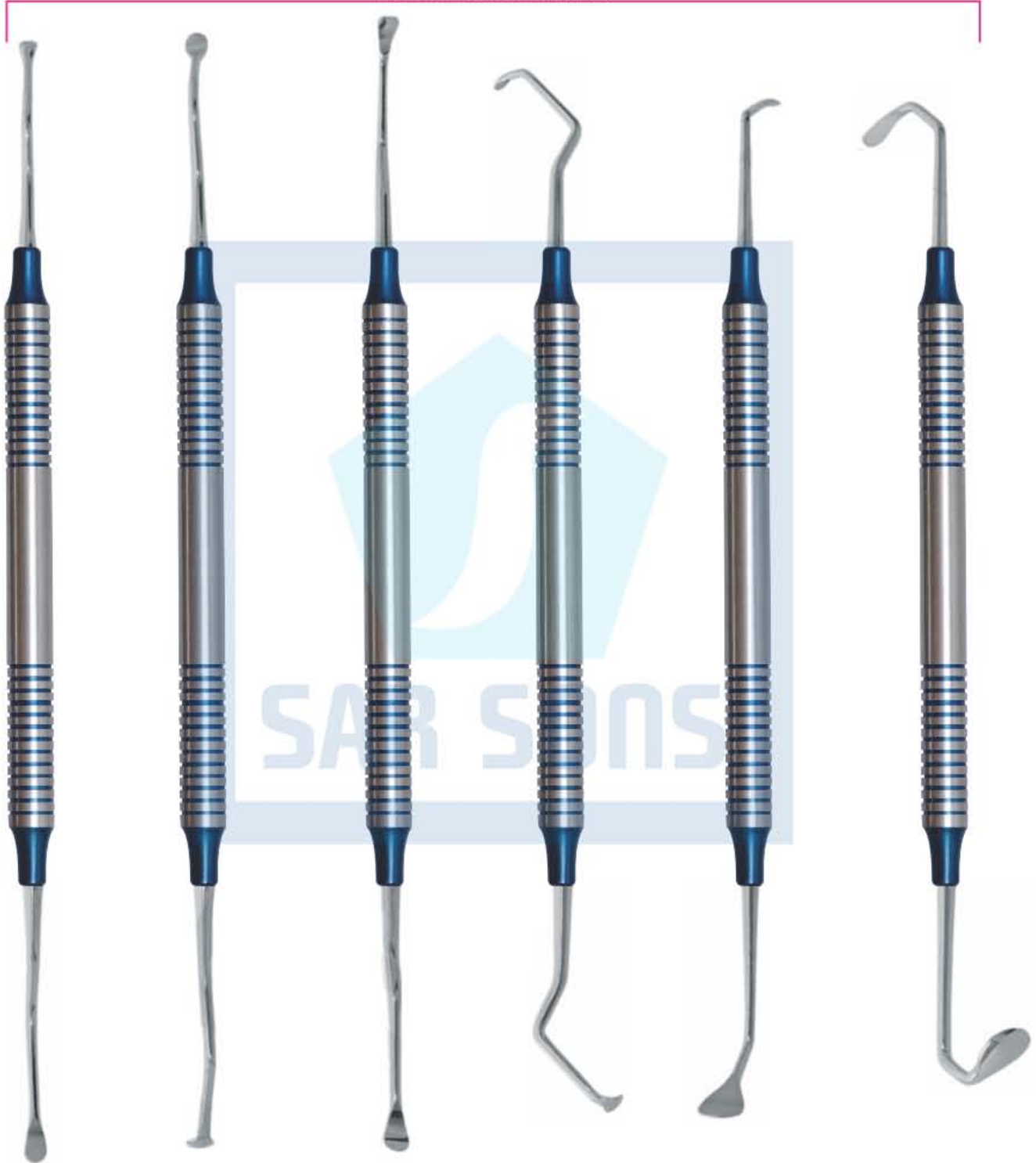

**SAR-2157**  
Sinus lift  
instrument  
H01

**SAR-2158**  
Sinus lift  
instrument  
H02

**SAR-2159**  
Sinus lift  
instrument  
K03

**SAR-2160**  
Sinus lift  
instrument  
K04

**SAR-2161**  
Sinus lift  
instrument  
K78

**SAR-2162**  
Sinus lift  
instrument  
K77

- Инструменты для имплантологии
  - Implantologie
  - Implantologie
- Інструменти для імплантології
  - Implantologia
  - زراعة الأسنان

## Composite Filling Instruments Set of 6 Pcs



SAR-2163



SAR-2164



SAR-2165



SAR-2166



SAR-2167



SAR-2168

### COMPOSITE INSTRUMENTS USE:

A composite (tooth colored) filling is used to repair a tooth that is affected by decay, cracks, fractures, etc. The decayed or affected portion of the tooth will be removed and then filled with a composite filling.

There are many types of filling materials available, each with their own advantages and disadvantages. You and your dentist can discuss the best options for restoring your teeth. Composite fillings, along with silver amalgam fillings, are the most widely used today. Because composite fillings are tooth colored, they can be closely matched to the color of existing teeth, and are more aesthetically suited for use in front teeth or the more visible areas of the teeth.

As with most dental restorations, composite fillings are not permanent and may someday have to be replaced. They are very durable, and will last many years, giving you a long lasting, beautiful smile.

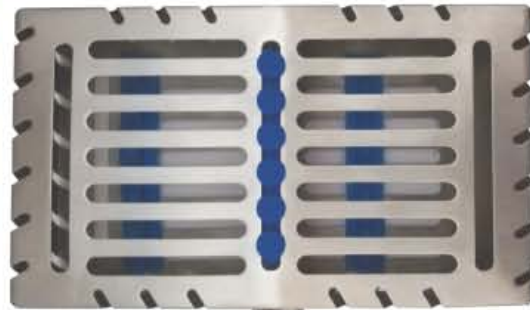

SAR-2169

# IMPLANTOLOGY



- Инструменты для имплантологии
- Implantologie
- Implantologie
- Инструменти для імплантології
- Implantologia
- زراعة الأسنان

Set of 5 Composite Gold Tip Instruments  
SAR-2170

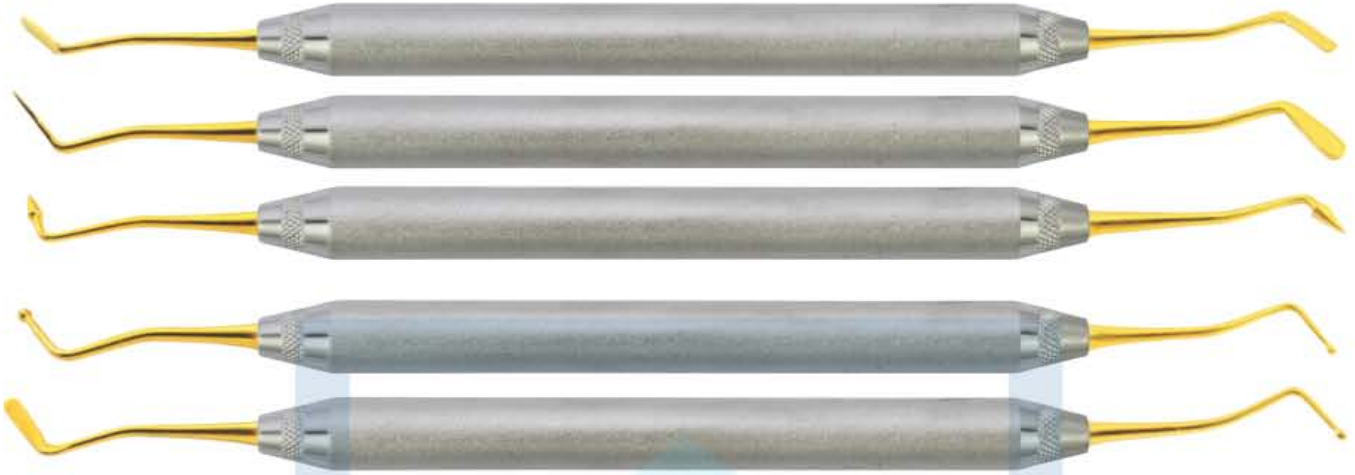

Set of 4 Composite Blue Tip Instruments  
SAR-2171

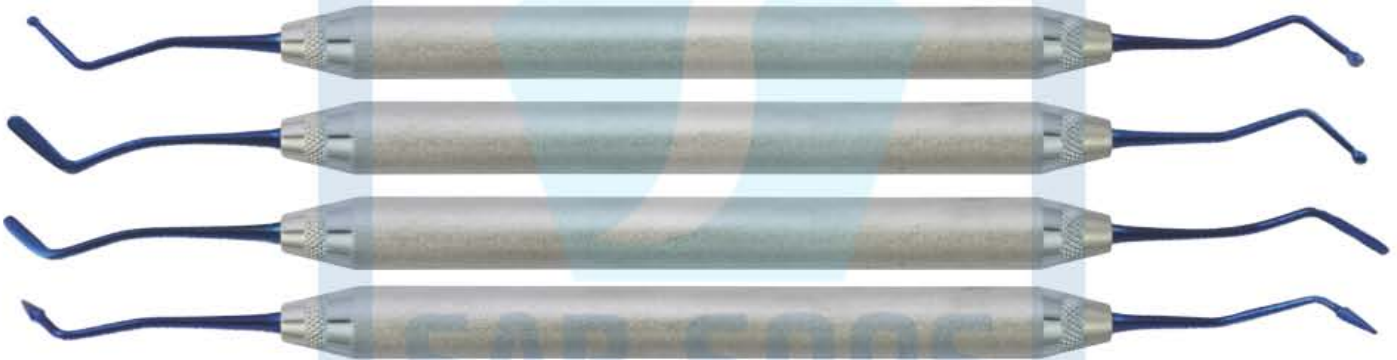

Set of 3 Composite Blue Tip Instruments  
SAR-2172



Set of 2 Composite Blue Tip Instruments  
SAR-2173



SAR-2174 Periosteal Elevators Molt # 9

SAR-2175 Endodontic explorer DG # 16

## IMPLANTOLOGY

- Инструменты для имплантологии
- Implantologie
- Implantologie
- Инструменти для імплантології
- Implantologia
- زراعة الأسنان

### VISTA TUNNELING INSTRUMENTS SET



SAR-2176



SAR-2177



SAR-2178



SAR-2179



SAR-2180



SAR-2181

SAR-2182



# IMPLANTOLOGY



- Инструменты для имплантологии
- Implantologie
- Implantologie

- Инструменти для імплантології
- Implantoloia
- زراعة الأسنان



**SAR-2183**  
used for elevation of sinus membrane



**SAR-2184**  
used for elevation of sinus membrane



**SAR-2185**  
Cobra in / out (2-4-5-6-8-10mm)



**SAR-2186**  
Cobra 3.5mm

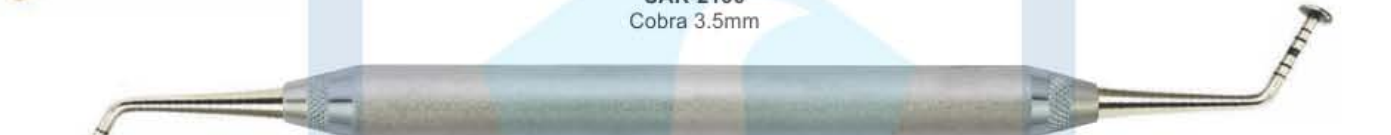

**SAR-2187**  
sinus 4.8 / 5.8 (2-4-5-6-8-10mm)

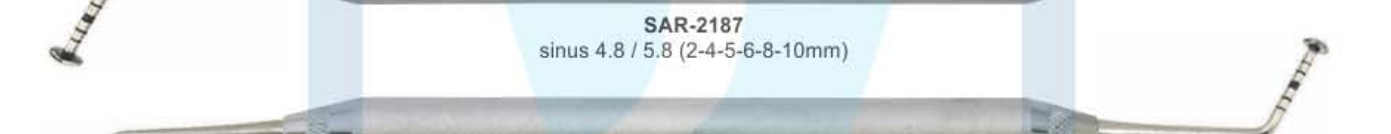

**SAR-2188**  
sinus 2.8 / 3.8 (2-4-5-6-8-10mm)



**SAR-2189**  
Bone Graft 3.8SP / 2.8mm (2-4-5-6-8-10mm)



**SAR-2190**  
Cobra in / out (2-4-5-6-8-10mm)



**SAR-2191**  
Cobra 3.5mm



**SAR-2192**  
Gold Color Set Dental Oral Implantology Sinus Set of 10 Pcs with cassette

## IMPLANTOLOGY

- Инструменты для имплантологии
- Implantologie
- Implantologie
- Инструменти для імплантології
- Implantoloia
- زراعة الأسنان



**SAR-2193**  
Sinus Lift elevator 1



**SAR-2194**  
Sinus Lift elevator 2



**SAR-2195**  
Sinus Lift elevator 3



**SAR-2196**  
Sinus Lift elevator 4



**SAR-2197**  
Sinus Lift elevator 5



**SAR-2198**  
Sinus Lift elevator 6



**SAR-2199**  
Sinus Lift Elevators Set of 7 Pcs  
with cassette

# IMPLANTOLOGY



- Инструменты для имплантологии
- Implantologie
- Implantologie
- Инструменти для імплантології
- Implantoloia
- زراعة الأسنان

## Sinus Left Elevator Set of 10 Pcs

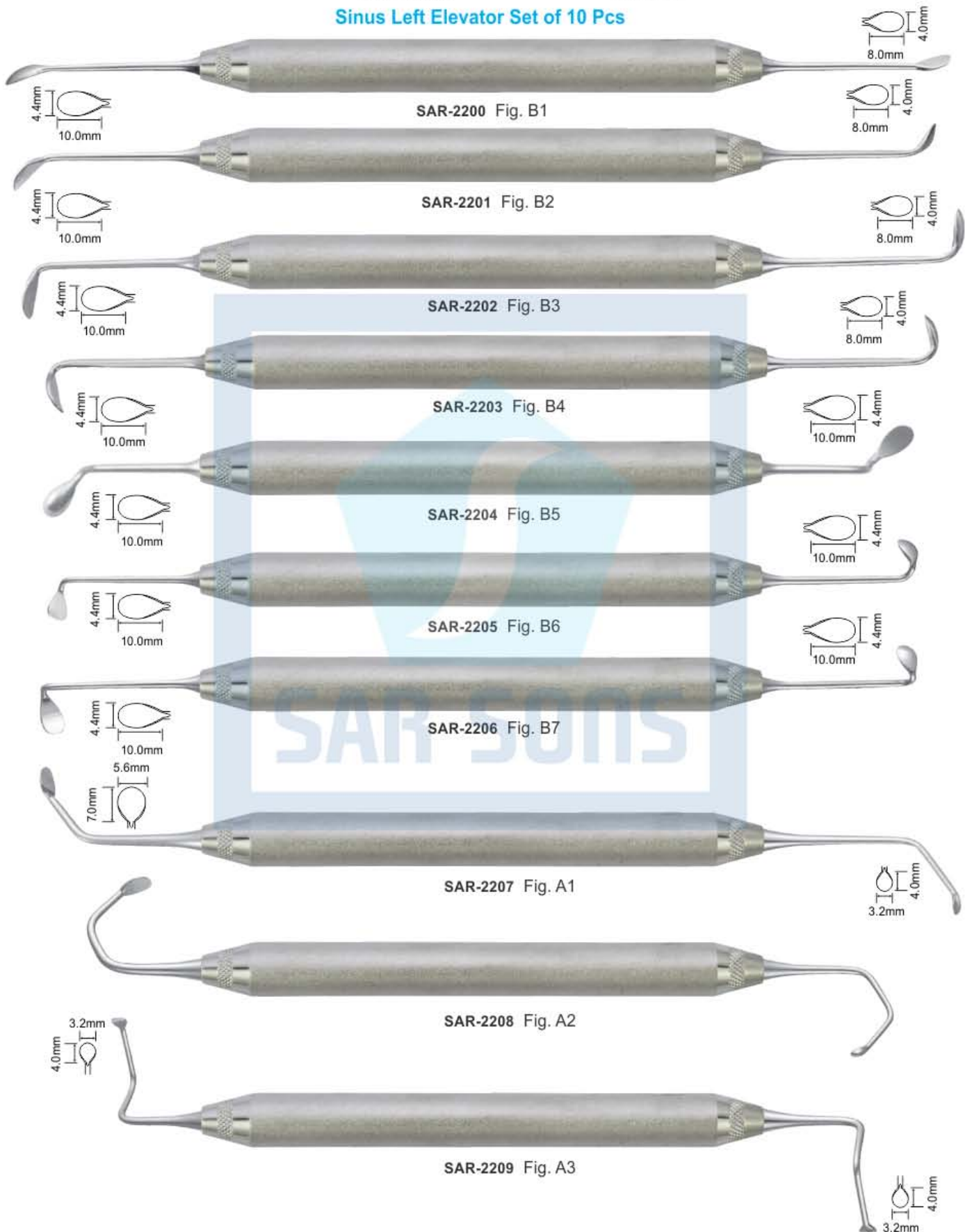

## IMPLANTOLOGY

- Инструменты для имплантологии
  - Implantologie
  - Implantologie
- Инструменти для імплантології
  - Implantoloia
  - زراعة الأسنان

### Blue Titanium Coated Bone Grafting Instruments

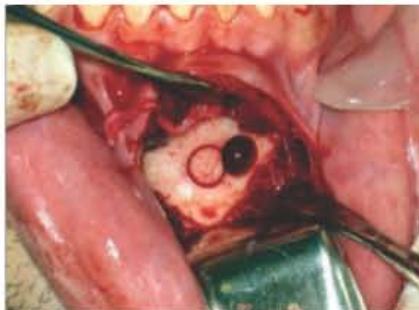

**SAR-2216**  
Blue Titanium Coated Bone Grafting Instruments Set of 7 Pcs with cassette



# IMPLANTOLOGY



- Инструменты для имплантологии
- Implantologie
- Implantologie

- Инструменти для имплантології
- Implantoloia
- زراعة الأسنان



SAR-2217  
Fig. 1



With curette the sinus membrane is further detached over a broad area in the inner region, especially along the roof of the palate.



SAR-2218  
Fig. 2



SAR-2219  
Fig. 3



SAR-2220  
Fig. 4



SAR-2221  
Fig. 5



SAR-2222  
Fig. 6



SAR-2223



SAR-2224



SAR-2225



SAR-2226



SAR-2227

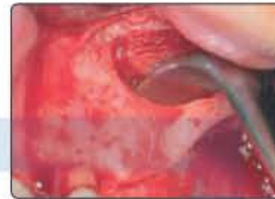

### Flexible Sinus-Lift Curettes – for an optimum sensitivity during the direct lift procedure

The perforation of the Schneiderian membrane is a complication that often occurs during a maxillary sinus floor augmentation procedure. The Sinus-Lift Instruments increase the sensitivity by blunt and flexible working tips with "Swing-Effect". Because of their special shapes and the characteristic of the stainless steel between the handle and the active part, light pressure is cushioned and gives the operator a direct and sensitive response. At the same time the risk to perforate the Schneiderian membrane is reduced to a minimum. Already at the development the focus was a practicable handling. Because of varying angulations and shapes of the active parts also in difficult areas they are easy to navigate also in difficult areas. The line of curettes consists of six different figures for every situation. They are complemented by spoon and condenser to place the bone graft.



The "Schneider's Membrane" of the sinus can be detached with curette by 1–2mm along the total cortical bone.



Curette is particularly useful in the lower part for detaching the membrane further. The same goes for the caudal area, especially when the membrane is 4–5 mm above the base of the maxillary sinus and the maxillary sinus is built up with granular material.



Curette makes it possible to lift the membrane further in mesial region. One working tip is especially designed for the right maxillary sinus and the other for the left maxillary sinus.



With curette the sinus membrane is further elevated in the upper and posterior part of the maxillary sinus wall.

# IMPLANTOLOGY

- Инструменты для имплантологии
  - Implantologie
  - Implantologie
- Инструменти для імплантології
  - Implantologia
  - زراعة الأسنان

## IMPLANT SINUS LIFT INSTRUMENTS HOLLOW HANDLE 9.5MM LENGTH 170MM

## SINUS LIFT INSTRUMENTS HOLLOW HANDLE 9.5MM LENGTH 170MM



**SAR-2228**  
Acute 6577

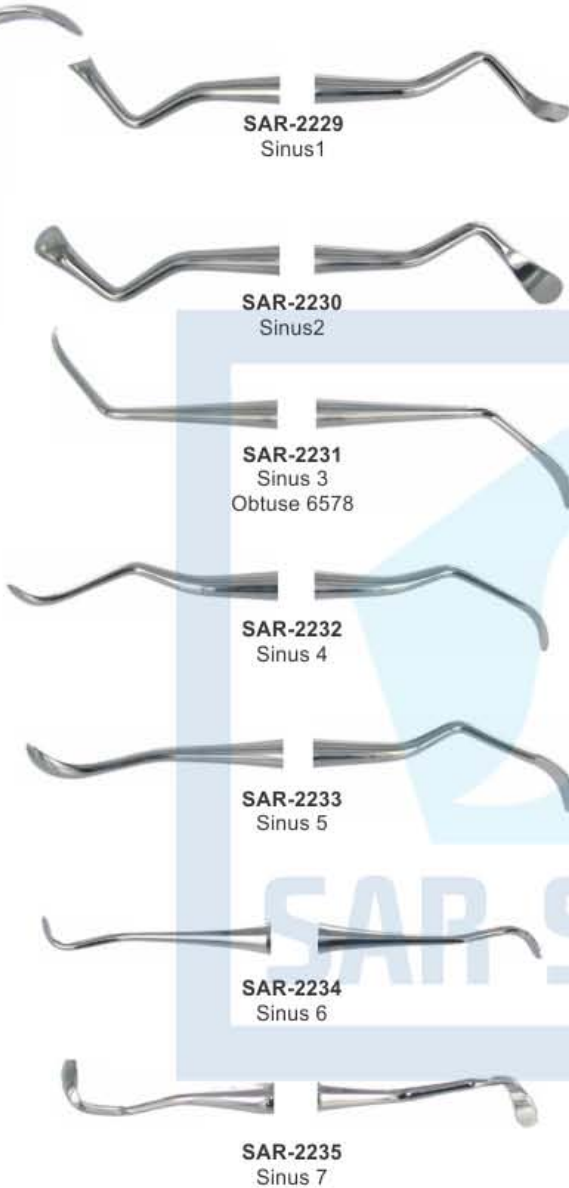

9 Pcs of Set  
**SAR-2236**



**SAR-2237**  
Sinuslift 1



9 Pcs of Set  
**SAR-2245**

# IMPLANTOLOGY



- Инструменты для имплантологии
- Implantologie
- Implantologie

- Инструменти для імплантології
- Implantoloia
- زراعة الأسنان

IMPLANT SINUS LIFT INSTRUMENTS  
 PERIODONTAL SURGERY SURGICAL CHISELS  
 KRAMER NEVINS SINUS LIFT

## SURGICAL CHISELS



SAR-2246  
TG



SAR-2247 SOLT3/4



SAR-2254 13K/TG



SAR-2248 TGO



SAR-2255  
13K/TG Titanium



SAR-2249 OCH3



SAR-2256 13K/TG



SAR-2250 OCH4



SAR-2257  
13KL/R Titanium



SAR-2251 FED11



SAR-2258 13KL 4/6mm  
Titanium Available



SAR-2252 FEDI2



SAR-2253 FEDI3



SAR-2259  
Cassette For Instruments

## IMPLANTOLOGY

- Инструменты для имплантологии
- Implantologie
- Implantologie
- Инструменти для імплантології
- Implantologia
- زراعة الأسنان

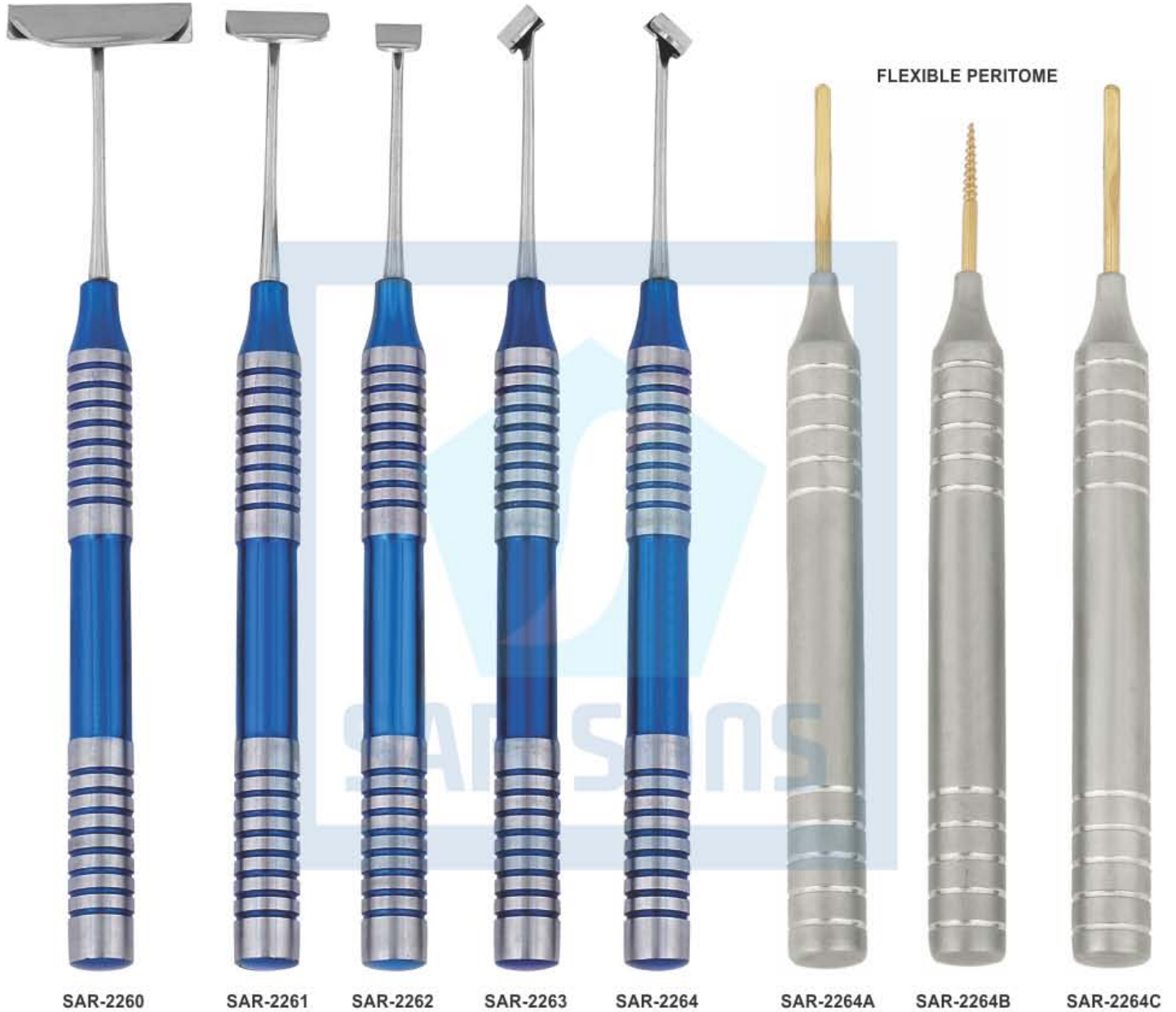

FLEXIBLE PERITOME

Soft Brushing Kit Set of 6 Pcs



# IMPLANTOLOGY



- Инструменты для имплантологии
  - Implantologie
  - Implantologie
- Інструменти для імплантології
  - Implantoloia
  - زراعة الأسنان

## SINUS ELEVATOR & MEMBRANE LIFT TIPS



**SAR-2265**  
Membrane Detach Elevator



**SAR-2266**  
Membrane Elevator



**SAR-2267**  
Membrane Elevator



**SAR-2268**  
Membrane Elevator



**SAR-2269**  
Membrane Elevator



**SAR-2270**  
Bone Graft Packer

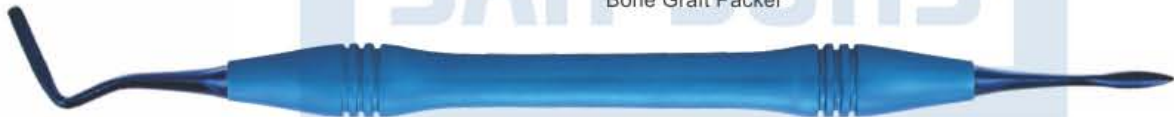

**SAR-2270A** Pt2 Titanium  
A/V Regular



**SAR-2270B** Pt1 Titanium  
A/V Regular



**SAR-2270C** Pt3 Titanium Angel S/E



**SAR-2270D** Pt4 Titanium STR S/E



**SAR-2270E** Pt5 Titanium TG CVD S/E



**SAR-2271**  
Sinus Left Elevator & Membrane Lift Tips 3  
set of 7 Pcs

- Инструменты для имплантологии
- Implantologie
- Implantologie
- Инструменти для імплантології
- Implantologia
- زراعة الأسنان

## MIXING SPATULA WITH SHOVEL



**SAR-2272**  
Bone Carrier  
Titanium



**SAR-2273**  
Raspator, Prichard  
Length 180 mm,  
10 mm hollow handle,  
double-ended  
10.5 mm | 4.5 mm,



**SAR-2274**  
Raspator, Prichard  
Length 180 mm,  
10 mm hollow handle,  
double ended



**SAR-2275**  
Raspator, Prichard  
Length 180 mm,  
10 mm hollow handle,  
double-ended  
10.5 mm | 4.5 mm,



**SAR-2276**  
Mixing Spatula  
with shovel  
17cm



**SAR-2277**  
Mixing Spatula  
with shovel  
18.5cm



**SAR-2278**  
Graft Material Spoon  
Concave Tip For  
Larger Grafts

## IMPLANTOLOGY

- Инструменты для имплантологии
  - Implantologie
  - Implantologie
- Инструменти для імплантології
  - Implantologia
  - زراعة الأسنان

### BONE GRAFTING INSTRUMENTS COMPACTOR /TAMPERS

Product offering includes instruments for harvesting, mixing and compacting bone Provides clinicians with the proper instrumentation for bone grafting procedures Weighted bone basin Prevents tipping and spilling of bone and other materials during mixing



**SAR-2279**  
Graft Packer, Concave Tips DE 4/6mm



**SAR-2280**  
Bone Spoon/ Packer DE 3mm



**SAR-2281**  
Blade and pusher Length 180 mm, for straight or angled, blade: 15 x 5 mm, pusher: 4 mm diameter Straight



**SAR-2282**  
Blade and pusher Length 180 mm, for straight or angled, blade: 15 x 5 mm, pusher: 4 mm diameter angular



**SAR-2283**  
Spoon and pusher Length 180 mm, for angled spoon: 10 x 5 mm, pusher: diameter 3 mm



**SAR-2284**  
Graft Packer, Smooth Tips DE 5/8mm



**SAR-2285**  
Graft Packer, Serrated Tips DE 3/4mm



**SAR-2286**  
Graft Packer, Serrated Tips DE 6/8mm



**SAR-2287**  
Titanium graft packer/placement site depth gauge 3.3mm & 4.0mm Diameter tips Marked at 8, 11, 13, 15 & 18mm



**SAR-2288**  
Tamper Length 170 mm, for bone material, double-ended, diameter 3.2 mm (2-4-6-8-10) and diameter 2.5mm (2-4-6-8-10)

- Инструменты для имплантологии
  - Implantologie
  - Implantologie
- Інструменти для імплантології
  - Implantologia
  - زراعة الأسنان

## SPOON AND PUSHER (TRINOVO)

Trinovo handle, different workers, for bone material, high-grade medical stainless steel, corrosion-resistant





# IMPLANTOLOGY



- Инструменты для имплантологии
- Implantologie
- Implantologie

- Інструменти для імплантології
- Implantoloia
- زراعة الأسنان

Hollow Handle 10mm Length 170mm



- Инструменты для имплантологии
- Implantologie
- Implantologie
- Инструменти для імплантології
- Implantoloia
- زراعة الأسنان

## TISSUE MEMBRANE FORCEPS



**SAR-2305**  
Tissue Graft Forcep  
Serrated Teeth



**SAR-2306**  
Self Locking  
Grooved



**SAR-2307**  
Tissue Graft Forcep  
Serrated Teeth



**SAR-2308**  
Titanium  
Locking Plier



**SAR-2309**  
TC Gripper Carbide  
Tipped Tissue Forceps  
Serrated Carbide Tips  
14.5cm



**SAR-2310**  
Adson Carbide  
Tipped Tissue Forceps  
Serrated Carbide Tips  
12cm



**SAR-2311**  
Micor Adson 1x2  
Tissue Forcep 12.1cm  
1x2 Teeth - 0.5mm Tips



**SAR-2312**  
Adson 7x7  
Tissue Forceps  
7x7 Teeth 12cm



**SAR-2313**  
Adson 7x7 Curved  
Tissue Forceps  
7x7 Teeth 12cm



**SAR-2314**  
Suture Pliers  
Suture Forceps with  
1.6mm Ring Tip



**SAR-2315**  
Debakey Atraumatic  
Tissue Forceps Straight  
Serrated Teeth  
16cm



**SAR-2316**  
Debakey Atraumatic  
Tissue Forceps Curved  
Serrated Teeth  
16cm

# IMPLANTOLOGY



- Инструменты для имплантологии
- Implantologie
- Implantologie
- Инструменти для имплантології
- Implantoloia
- زراعة الأسنان

## TISSUE MEMBRANE FORCEPS



**SAR-2317**  
Russian Long  
Tissue Forceps  
Serrated Tip  
20cm



**SAR-2318**  
Russian  
Tissue Forceps  
Serrated Tip  
15cm



**SAR-2319**  
Tissue Punch Forceps  
To Remove Tissue  
After Using Punch



**SAR-2320**  
13.5 cm  
narrow



**SAR-2321**  
10.5 cm  
**Membrane tweezers KUEHNE**



**SAR-2322**  
13.5 cm  
wide



**SAR-2323**  
**Pin-Tweezers**  
with or without lock,  
length 15 cm,  
with lock



**SAR-2324**  
without lock



**SAR-2325**  
**Haltepinzette with lock**  
15,5 cm, for pins, towards  
the tips, etc



**SAR-2326**  
Carry Forceps  
15cm



**SAR-2327**  
Carry Forceps  
15cm



**SAR-2328**  
Carry Forceps  
15cm

- Инструменты для имплантологии
- Implantologie
- Implantologie
- Инструменти для імплантології
- Implantoloia
- زراعة الأسنان

## OSTEOTOME CONVEXES / CONCAVE / CONIQUES

CONVEXES

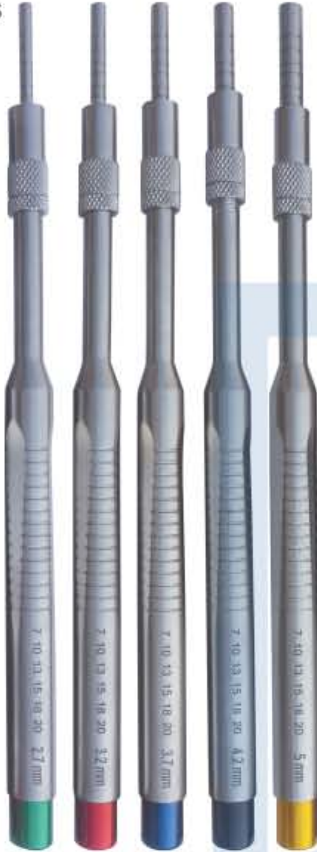

**SAR-2329**  
SET OF 5 PIECES

CONCAVES

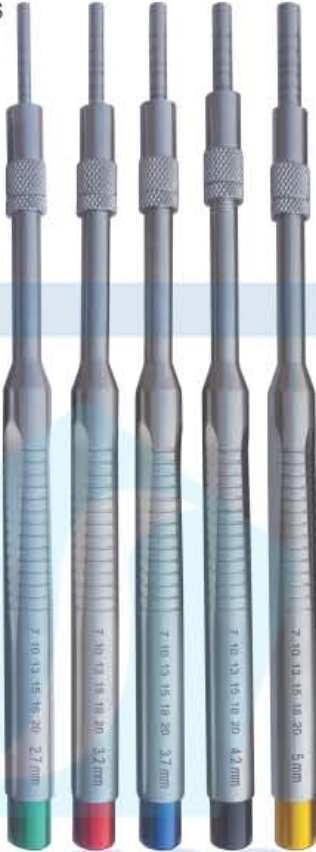

**SAR-2330**  
SET OF 5 PIECES

CONIQUES



**SAR-2331**  
SET OF 5 PIECES

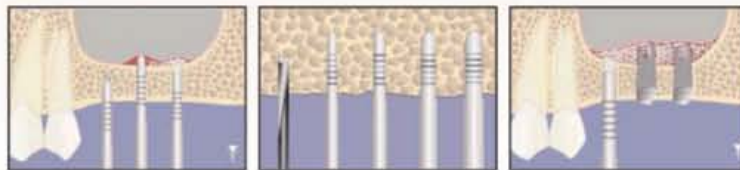

	CONVEXES STRAIGHT	<b>SAR-2329</b>	2,7 Ømm	3,2 Ømm	3,7 Ømm	4,2 Ømm	5 Ømm
	CONCAVES STRAIGHT	<b>SAR-2330</b>	2,7 Ømm	3,2 Ømm	3,7 Ømm	4,2 Ømm	5 Ømm
	CONIQUES STRAIGHT	<b>SAR-2331</b>	2,7 Ømm	3,2 Ømm	3,7 Ømm	4,2 Ømm	5 Ømm

# IMPLANTOLOGY



- Инструменты для имплантологии
- Implantologie
- Implantologia
- زراعة الأسنان

## OSTEOTOME CONVEXES / CONCAVE / CONIQUES

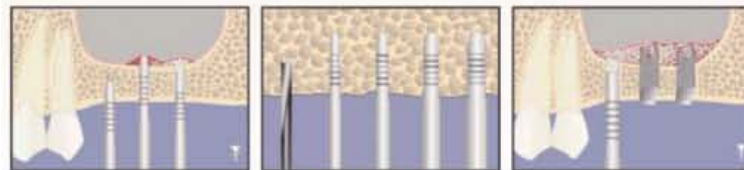

	CONVEXES CURVED	<b>SAR-2332</b>	2,7 Ømm	3,2 Ømm	3,7 Ømm	4,2 Ømm	5 Ømm
	CONCAVES CURVED	<b>SAR-2333</b>	2,7 Ømm	3,2 Ømm	3,7 Ømm	4,2 Ømm	5 Ømm
	CONIQUES CURVED	<b>SAR-2334</b>	2,7 Ømm	3,2 Ømm	3,7 Ømm	4,2 Ømm	5 Ømm

# IMPLANTOLOGY

- Инструменты для имплантологии
- Implantologie
- Implantologia
- زراعة الأسنان

## BONE SCRAPER STRAIGHT & CURVED



**SAR-2335**  
Bone Scraper  
Straight



**SAR-2336**  
Bone Scraper  
Curved

## TISSUE PUNCH STRAIGHT & CURVED



Tissue Punch  
Straight



Tissue Punch  
Curved

●  
**SAR-2337**  
2.0mm

●  
**SAR-2338**  
4.0mm

●  
**SAR-2339**  
5.0mm

●  
**SAR-2340**  
6.0mm

●  
**SAR-2341**  
7.0mm

●  
**SAR-2342**  
8.0mm

●  
**SAR-2343**  
2.0mm

●  
**SAR-2344**  
4.0mm

●  
**SAR-2345**  
5.0mm

●  
**SAR-2346**  
6.0mm

●  
**SAR-2347**  
7.0mm

●  
**SAR-2348**  
8.0mm

SAR SONS

Ø4.0 Ø5.0 Ø6.0 Ø7.0



**SAR-2349**  
Tissue Punch with pin  
Set of Four Pieces



**SAR-2350**  
Tissue Punch  
Set of Five Pieces



**SAR-2351**  
Tissue Punch  
Set of Five Pieces

# IMPLANTOLOGY

- Инструменты для имплантологии
- Implantologie
- Implantsologie
- Инструменти для імплантології
- Implantologia
- زراعة الأسنان

## BONE MILL BONE WELL

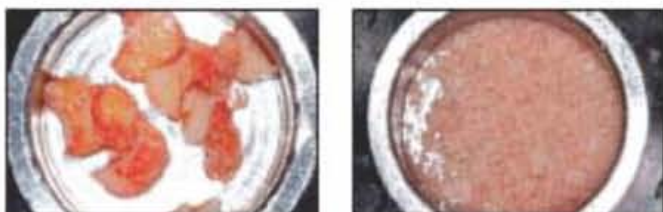

## IMPLANTOLOGY

- Инструменты для имплантологии
- Implantologie
- Implantologie
- Инструменти для імплантології
- Implantologia
- زراعة الاسنان

### TREPHINE

Burs with depth markings are suited for precise and simple transplantation of cylindrical bone grafts as well as for all other bone-extraction tasks.



**SAR-2367**  
Trepine Drill  
Set of Eight Pieces



**SAR-2368**  
Trepine Drill  
Set of Eight Pieces

### BONE INJECTORS, COLLECTORS & SUCTION TUBE

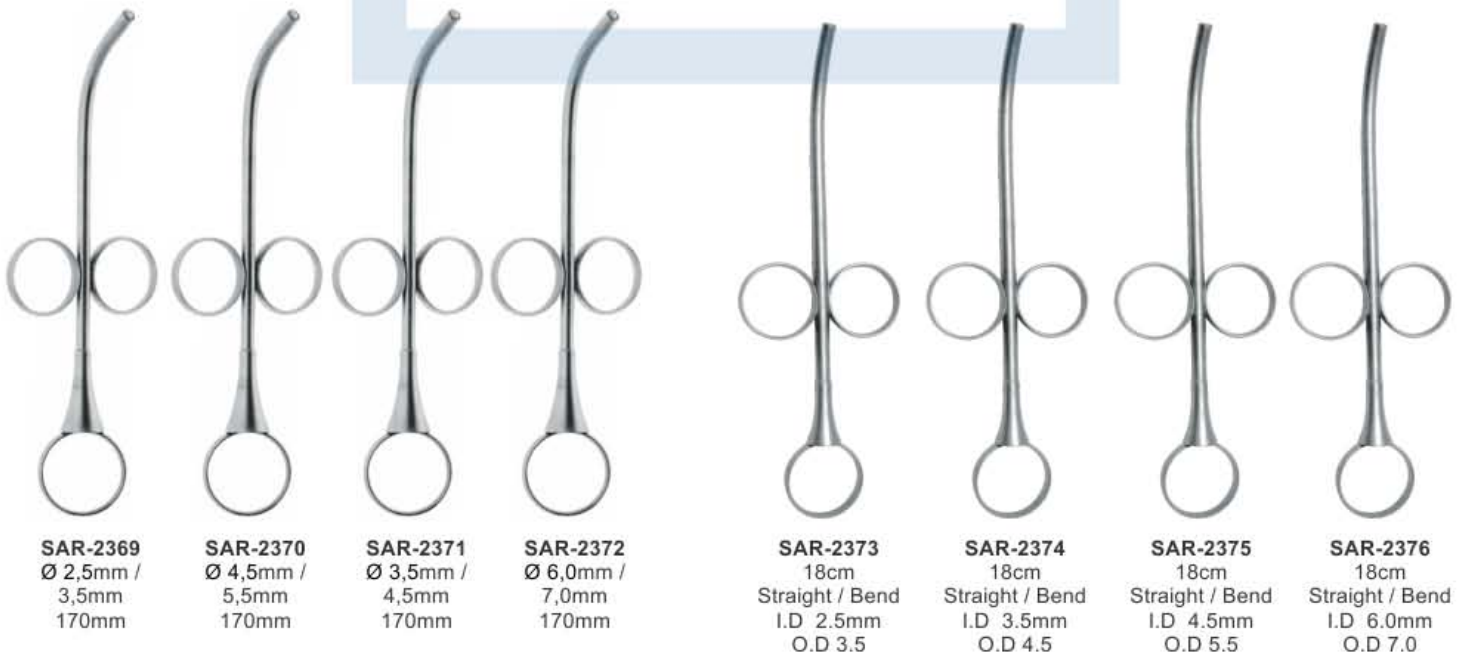



# IMPLANTOLOGY

- Инструменты для имплантологии
  - Implantologie
  - Implantologie
- Инструменти для імплантології
  - Implantoloia
  - زراعة الأسنان

## BONE EXPANDER SCREW & SURGICAL KITS



Ø2.0mm Ø2.5mm Ø2.8mm

**SAR-2377** Short Implant Drills



Ø3.2mm Ø3.65mm Ø4.2mm Ø5.2mm

**SAR-2378** Long Implant Drills



**SAR-2379**

Bone Universal Kit

Drill: 2mm, 2.8mm, 3.2mm, 3.65mm, 4.2mm, 4.5mm, 4.8mm, 5.2mm  
 Trepines Bit: 3.0mm, 4.0mm, 5.0mm, 6.0mm, 7.0mm, 8.0mm, 9.0mm, 10mm.  
 Driver: 2.5mm, 2.5mm Hand Pcs, 1.25mm, 1.25mm Hand Pcs  
 Short Driver 2.5mm, Long Driver 2.5mm  
 1.25mm, Short Hex Driver Hand Pcs  
 1.25mm, Long Hex Driver Hand Pcs, Torque Wrench 4.0mm



**SAR-2380**

Bone Expander Kit

Expander: 2.6mm, 3.0mm, 3.4mm, 3.8mm, 4.3mm  
 Ratchet Driver, Parallel Pin  
 Pilot Drill, Drill 1.4mm, Drill Driver 4mm  
 Hand Driver 4mm, Ratchet 4.0mm



**SAR-2381**

Bone Universal Kit

Drill: 2mm, 2.8mm, 3.2mm, 3.65mm, 4.2mm, 4.5mm, 4.8mm, 5.2mm  
 Trepines Bit: 3.0mm, 4.0mm, 5.0mm, 6.0mm, 7.0mm, 8.0mm, 9.0mm, 10mm.

Bone Compression: 2mm, 3.3mm, 2.8mm, 4.2mm, 3mm, 3.5mm  
 Driver: 2.5mm, 2.5mm Hand Pcs  
 1.25mm, 1.25mm Hand Pcs  
 Short Driver 2.5mm  
 Long Driver 2.5mm  
 1.25mm, Short Hex Driver Hand Pcs  
 1.25mm, Long Hex Driver Hand Pcs  
 Torque Wrench 6.35mm 1 Pcs



**SAR-2382**

Bone Expander Kit

Conical Drills: 20 Pcs  
 Tissue Punches: 3.0mm, 3.50mm, 4.0mm, 4.5mm, 5.0mm, 6.0mm, 6.50mm  
 Bone Expander: 1.6/3.8mm, 1.9/3.0mm, 2.1/3.6mm, 2.6/3.8mm, 2.9/4.3mm  
 Drill Adapter: 1 Pcs  
 1.25mm, 2.50mm Hex Driver Hand Pcs

Pilot Drill: 1.6mm  
 Drill Bit: 1.4mm, 1.6mm, 1.8mm, 2.0mm, 2.2mm  
 Ratchet Driver: 4mm/6.35, 1.25/2.50  
 Rimer: 3.2/4.7mm, 3.7/4.7mm  
 Parallel Pin: 4.5mm, 2.5mm  
 Double step Drill: 2.4/2.8mm  
 Depth Gauge: 1 Pcs  
 Torque Wrench 6.35mm Universal: 1 Pcs

- Инструменты для имплантологии
  - Implantologie
  - Implantologie
- Инструменти для імплантології
  - Implantologia
  - زراعة الأسنان

## KEYS FOR IMPLANT SCREW



SAR-2383



SAR-2384



SAR-2385



SAR-2386

## TORQUE WRENCH & RATCHET



SAR-2387 Star Torque Wrench 6.35mm Universal



SAR-2388 Round Torque Wrench 4.0mm Universal



SAR-2389 Hex Driver With 4.0mm Driver



SAR-2390 Star Torque Wrench 6.35mm Universal



SAR-2391 Hex Torque Wrench 4.00mm Universal



SAR-2392 Star Torque Wrench 6.35mm Universal



SAR-2393 Star Torque Wrench 6.35mm Universal



SAR-2394 Star Torque Wrench 6.35mm Universal



SAR-2395 Star Torque Wrench 6.35mm Universal



SAR-2396 Star Torque Wrench 6.35mm Universal



SAR-2397 Star Ratchet Wrench 6.35mm Universal



SAR-2398 Star Ratchet Wrench 6.35mm Universal



SAR-2399 Star Ratchet Wrench 6.35mm Universal



SAR-2400 Star Ratchet Wrench 4.0mm Universal



SAR-2401 Round Ratchet Wrench 4.0mm Universal



SAR-2402 Round Ratchet Wrench 3.35mm Universal



SAR-2403 Star Ratchet Wrench 4.0mm Universal



SAR-2404 Star Ratchet Wrench 6.35mm Universal

# IMPLANTOLOGY

- Инструменты для имплантологии
  - Implantologie
  - Implantologia
- Инструменти для імплантології
  - Implantoloia
  - زراعة الأسنان



**SAR-2405**  
Suction Cannula Kit  
with 3 Needles



Suction Pipe



Suction Needle  
1mm



Suction Needle  
1.5mm



Suction Needle  
2mm



**SAR-2406**  
17.5cm

**SAR-2407**  
18cm



**SAR-2408**  
Suction tubes  
to collect  
the extracted  
bone material  
180mm  
coarse  
Ø 5mm



**SAR-2409**  
fine  
Ø 9mm



**SAR-2410**  
Suction  
Tubes  
180mm

**SAR-2411**  
Suction  
Tubes  
180mm

**SAR-2412**  
Suction  
Tubes  
180mm



**SAR-2414**  
Ø 3 mm  
length 180mm  
**SAR-2415**  
Ø 4 mm  
length 180mm  
**SAR-2416**  
Ø 5 mm  
length 180mm  
**SAR-2413**  
Fig. 6FR  
Frazier  
15 cm - Ø 2 mm

## IMPRESSION TRAYS

- Оттисные ложки
- Porte-empreinte
- Abdrucklöffel
- Відбиткові ложки
- Cubetas para impresiones
- صواني الانطباع

### PERFORATED WITH RIM LOCK

Set of 06 Pcs

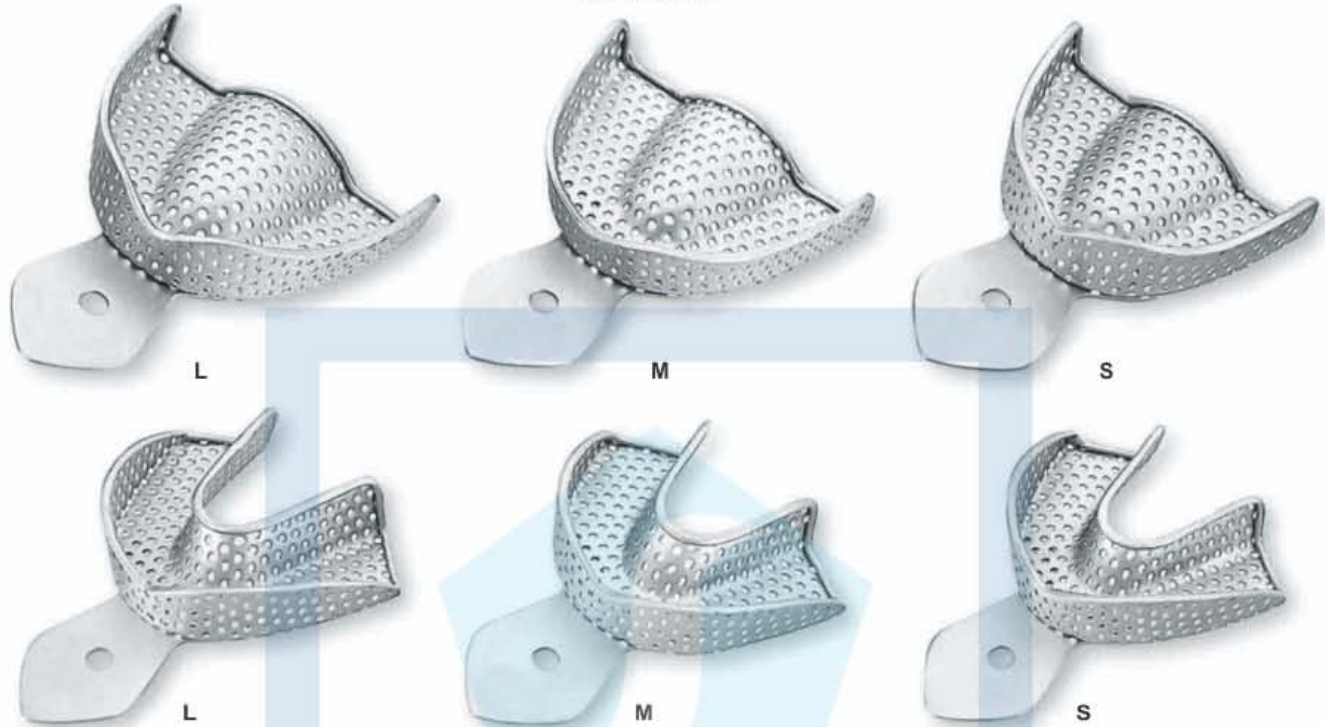

#### SAR-2417 SET OF 06 PCS

Upper: S, M, L  
Lower: S, M, L

### PERFORATED WITH RIM LOCK

Set of 8 Pcs



#### SAR-2418 SET OF 08 PCS

Upper: XS, S, M, L  
Lower: XS, S, M, L

#### SAR-2419 SET OF 08 PCS

Upper: S, M, L, XL  
Lower: S, M, L, XL

#### SAR-2420 SET OF 10 PCS

Upper: XS, S, M, L, XL  
Lower: XS, S, M, L, XL

## IMPRESSION TRAYS

- Оттисковые ложки
- Porte-empreinte
- Abdrucklöffel
- Відбиткові ложки
- Cubetas para impresiones
- صواني الانطباع

### SOLID WITH RIM LOCK

Set of 6 Pcs



#### SAR-2421 SET OF 06 PCS

Upper: S, M, L  
Lower: S, M, L

### SOLID WITH RIM LOCK

Set of 8 Pcs



#### SAR-2422 SET OF 08 PCS

Upper: XS, S, M, L  
Lower: XS, S, M, L

#### SAR-2423 SET OF 08 PCS

Upper: S, M, L, XL  
Lower: S, M, L, XL

#### SAR-2424 SET OF 10 PCS

Upper: XS, S, M, L, XL  
Lower: XS, S, M, L, XL

## IMPRESSION TRAYS

- Оттисковые ложки
- Porte-empreinte
- Abdrucklöffel
- Відбиткові ложки
- Cubetas para impresiones
- صواني الانطباع

### PERFORATED FULL DENTURE

Set of 8 Pcs

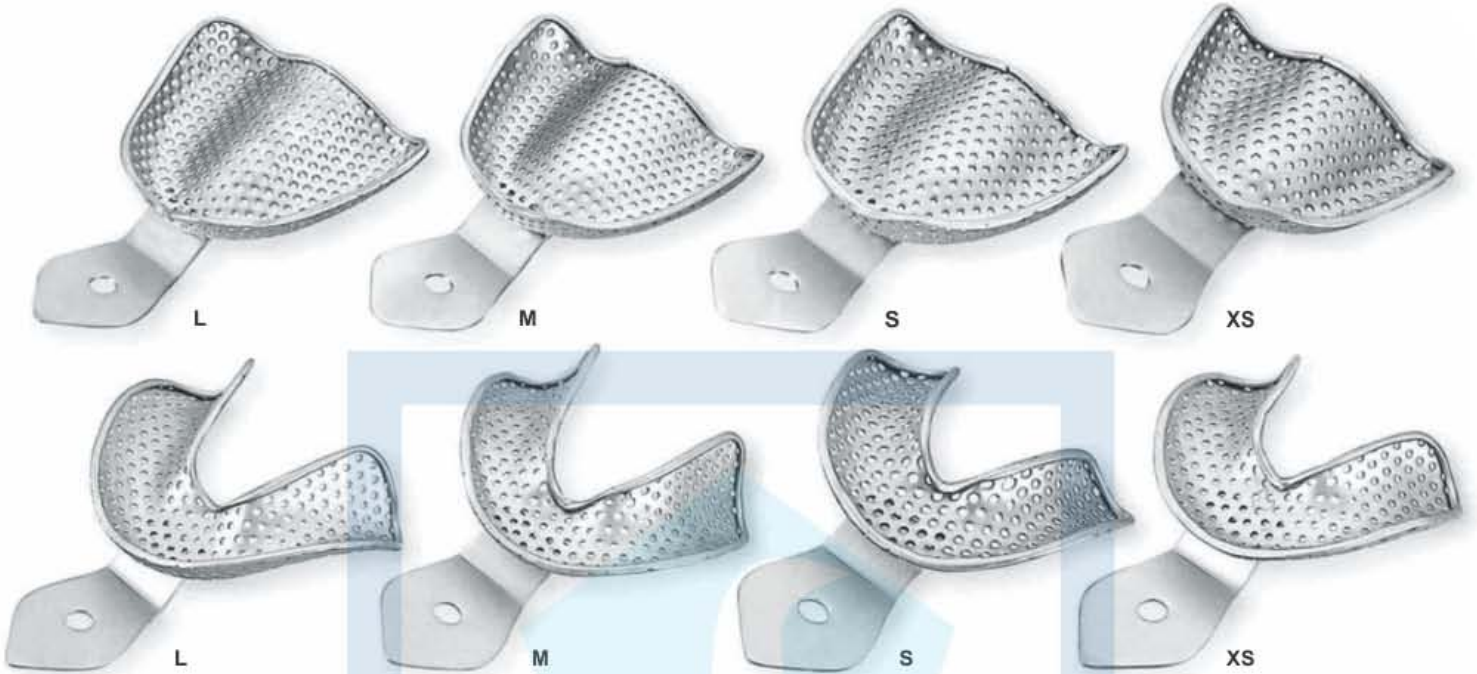

**SAR-2425 SET OF 08 PCS**  
Upper: S, M, L, XL  
Lower: S, M, L, XL

**SAR-2426 SET OF 08 PCS**  
Upper: S, M, L  
Lower: S, M, L

### SOLID FULL DENTURE

Set of 8 Pcs

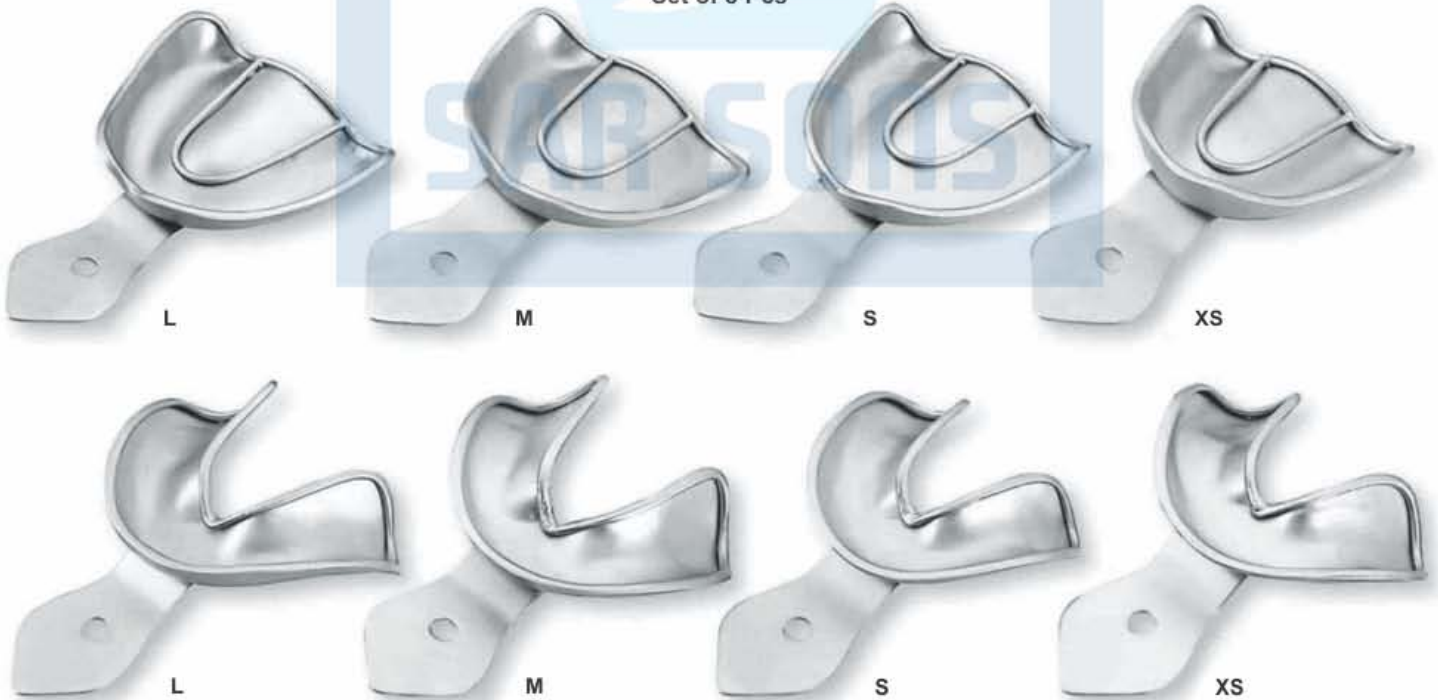

**SAR-2427 SET OF 08 PCS**  
Upper: S, M, L, XL  
Lower: S, M, L, XL

**SAR-2428 SET OF 06 PCS**  
Upper: S, M, L  
Lower: S, M, L

## IMPRESSION TRAYS

- Оттисные ложки
- Porte-empreinte
- Abdrucklöffel
- Відбиткові ложки
- Cubetas para impresiones
- صواني الانطباع

### Perforated Without Rim Lock

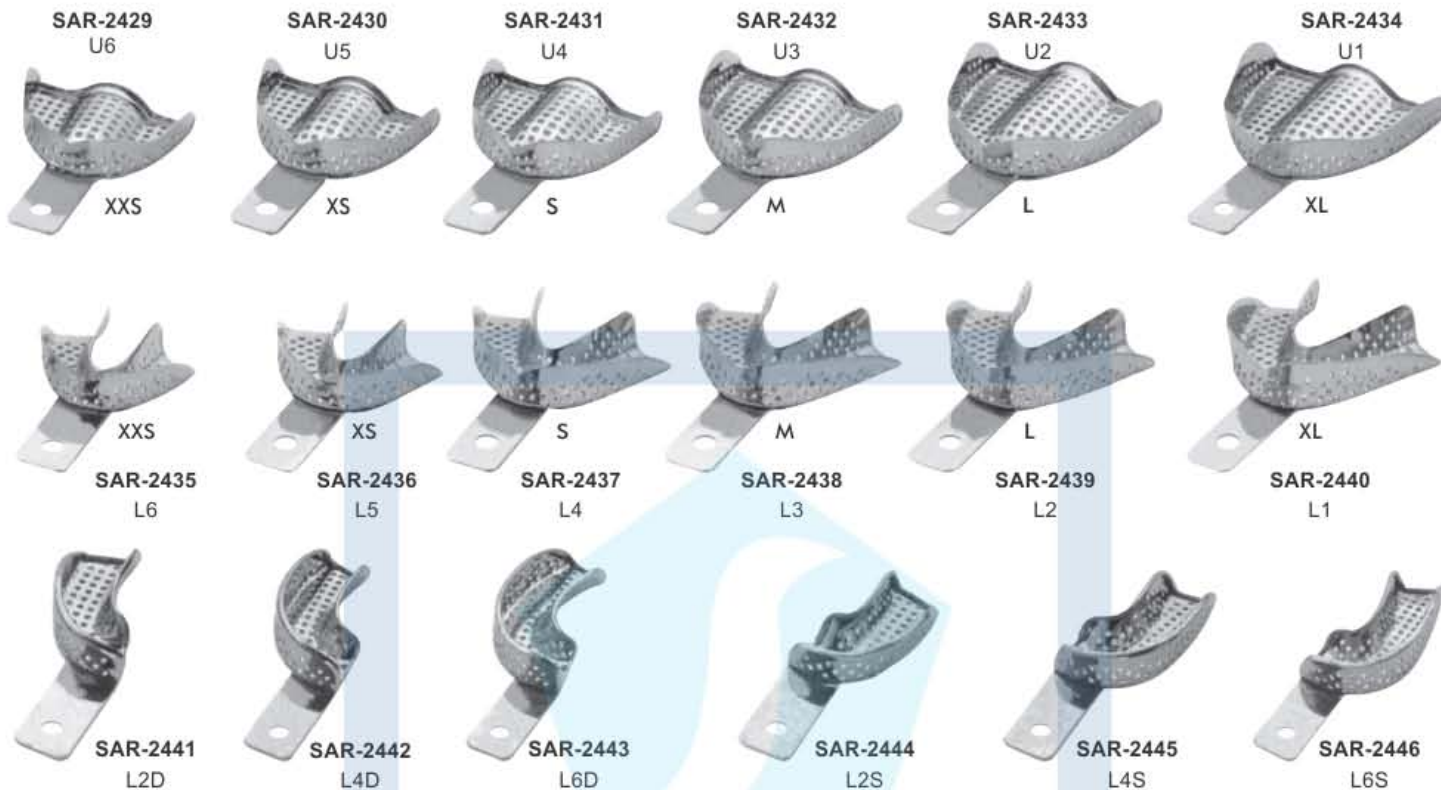

### Solid With Rim Lock







# HOLLOWARE INSTRUMENTS



**Scalers Tray**  
SAR-2500 200 x 100 mm



**Scalers Trays**  
SAR-2501 205 x 115 x 17 mm  
SAR-2502 205 x 152 x 17 mm  
SAR-2503 290 x 115 x 17 mm

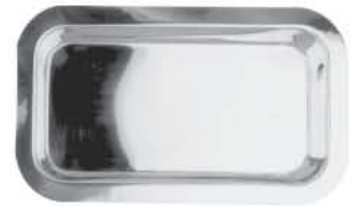

**Instruments Trays**  
SAR-2504 200 x 110 x 30 mm  
SAR-2505 215 x 115 x 35 mm  
SAR-2506 220 x 130 x 30 mm  
SAR-2507 230 x 125 x 35 mm  
SAR-2508 245 x 140 x 40 mm  
SAR-2509 285 x 160 x 45 mm  
SAR-2510 315 x 175 x 50 mm  
SAR-2511 330 x 185 x 50 mm



**Instruments Trays**  
SAR-2512 150 x 100 x 50 mm  
SAR-2513 200 x 100 x 50 mm  
SAR-2514 220 x 120 x 50 mm  
SAR-2515 240 x 140 x 50 mm  
SAR-2516 200 x 150 x 50 mm  
SAR-2517 250 x 200 x 50 mm  
SAR-2518 300 x 250 x 50 mm  
SAR-2519 300 x 200 x 50 mm  
SAR-2520 350 x 250 x 50 mm  
SAR-2521 400 x 300 x 50 mm  
SAR-2522 450 x 300 x 50 mm  
SAR-2523 450 x 350 x 50 mm



**Instruments Trays With Lid**  
SAR-2524 150 x 100 x 50 mm  
SAR-2525 200 x 100 x 50 mm  
SAR-2526 220 x 120 x 50 mm  
SAR-2527 240 x 140 x 50 mm  
SAR-2528 200 x 150 x 50 mm  
SAR-2529 250 x 200 x 50 mm  
SAR-2530 300 x 250 x 50 mm  
SAR-2531 300 x 200 x 50 mm  
SAR-2532 350 x 250 x 50 mm  
SAR-2533 400 x 300 x 50 mm  
SAR-2534 450 x 300 x 50 mm  
SAR-2535 450 x 350 x 50 mm



**Mayo Tray Perforated**  
SAR-2536 150 x 100 x 25 mm  
SAR-2537 200 x 100 x 25 mm  
SAR-2538 220 x 120 x 25 mm  
SAR-2539 240 x 140 x 25 mm  
SAR-2540 200 x 150 x 25 mm  
SAR-2541 250 x 200 x 25 mm  
SAR-2542 300 x 250 x 25 mm  
SAR-2543 300 x 200 x 25 mm  
SAR-2544 350 x 250 x 25 mm  
SAR-2545 400 x 300 x 25 mm  
SAR-2546 450 x 300 x 25 mm  
SAR-2547 450 x 350 x 25 mm



**Scaler Tray**  
SAR-2548 200 x 115 mm  
SAR-2549 205 x 150 mm  
SAR-2550 290 x 150 mm  
SAR-2551 300 x 200 mm



**Instruments Tray Perforated**  
SAR-2552 150 x 100 x 50 mm  
SAR-2553 200 x 100 x 50 mm  
SAR-2554 220 x 120 x 50 mm  
SAR-2555 240 x 140 x 50 mm  
SAR-2556 200 x 150 x 50 mm  
SAR-2557 250 x 200 x 50 mm  
SAR-2558 300 x 250 x 50 mm  
SAR-2559 300 x 200 x 50 mm  
SAR-2560 350 x 250 x 50 mm  
SAR-2561 400 x 300 x 50 mm  
SAR-2562 450 x 300 x 50 mm  
SAR-2563 450 x 350 x 50 mm

## Sterilizing boxes & instruments Trays



### Instruments Box with Hooks

<b>SAR-2564</b>	170 x 70 x 30 mm
<b>SAR-2565</b>	180 x 80 x 40 mm
<b>SAR-2566</b>	200 x 100 x 40 mm
<b>SAR-2567</b>	200 x 100 x 50 mm
<b>SAR-2568</b>	220 x 120 x 50 mm
<b>SAR-2569</b>	250 x 150 x 50 mm
<b>SAR-2570</b>	250 x 200 x 50 mm
<b>SAR-2571</b>	300 x 150 x 60 mm
<b>SAR-2572</b>	300 x 200 x 50 mm
<b>SAR-2573</b>	350 x 250 x 50 mm
<b>SAR-2574</b>	400 x 200 x 100 mm
<b>SAR-2575</b>	450 x 250 x 50 mm



### Instruments Box

<b>SAR-2576</b>	170 x 70 x 30 mm
<b>SAR-2577</b>	180 x 80 x 40 mm
<b>SAR-2578</b>	200 x 100 x 40 mm
<b>SAR-2579</b>	200 x 100 x 50 mm
<b>SAR-2580</b>	220 x 120 x 50 mm
<b>SAR-2581</b>	250 x 150 x 50 mm
<b>SAR-2582</b>	250 x 200 x 50 mm
<b>SAR-2583</b>	300 x 150 x 60 mm
<b>SAR-2584</b>	300 x 200 x 50 mm
<b>SAR-2585</b>	350 x 250 x 50 mm
<b>SAR-2586</b>	400 x 200 x 100 mm
<b>SAR-2587</b>	450 x 250 x 50 mm



### Instruments Box Perforated

<b>SAR-2588</b>	170 x 70 x 30 mm
<b>SAR-2589</b>	180 x 80 x 40 mm
<b>SAR-2590</b>	200 x 100 x 40 mm
<b>SAR-2591</b>	200 x 100 x 50 mm
<b>SAR-2592</b>	220 x 120 x 50 mm
<b>SAR-2593</b>	250 x 150 x 50 mm
<b>SAR-2594</b>	250 x 200 x 50 mm
<b>SAR-2595</b>	300 x 150 x 60 mm
<b>SAR-2596</b>	300 x 200 x 50 mm
<b>SAR-2597</b>	350 x 250 x 50 mm
<b>SAR-2598</b>	400 x 200 x 100 mm
<b>SAR-2599</b>	450 x 250 x 50 mm



### Gloves Box

<b>SAR-2600</b>	300 x 150 mm
-----------------	--------------



### Catheters Tray with lid

<b>SAR-2601</b>	200 x 60 x 40 mm
<b>SAR-2602</b>	200 x 90 x 40 mm
<b>SAR-2603</b>	320 x 95 x 50 mm
<b>SAR-2604</b>	328 x 90 x 50 mm
<b>SAR-2605</b>	365 x 90 x 50 mm
<b>SAR-2606</b>	440 x 115 x 50 mm



### Box With Filter

<b>SAR-2607</b>	100 x 50 mm
<b>SAR-2608</b>	250 x 150 mm
<b>SAR-2609</b>	150 x 65 mm
<b>SAR-2610</b>	200 x 100 mm
<b>SAR-2611</b>	300 x 200 mm



### Instruments Trays With Cover

<b>SAR-2612</b>	210 x 110 x 50 mm
<b>SAR-2613</b>	240 x 160 x 50 mm
<b>SAR-2614</b>	300 x 180 x 50 mm
<b>SAR-2615</b>	360 x 210 x 50 mm
<b>SAR-2616</b>	400 x 230 x 55 mm

### Instruments Trays Without Cover

<b>SAR-2617</b>	210 x 110 x 50 mm
<b>SAR-2618</b>	240 x 160 x 50 mm
<b>SAR-2619</b>	300 x 180 x 50 mm
<b>SAR-2620</b>	360 x 210 x 50 mm
<b>SAR-2621</b>	400 x 230 x 55 mm



### Instruments Box with lid

<b>SAR-2622</b>	170 x 70 x 30 mm
<b>SAR-2623</b>	180 x 80 x 40 mm
<b>SAR-2624</b>	200 x 100 x 40 mm
<b>SAR-2625</b>	200 x 100 x 50 mm
<b>SAR-2626</b>	220 x 120 x 50 mm
<b>SAR-2627</b>	250 x 150 x 50 mm
<b>SAR-2628</b>	250 x 200 x 50 mm
<b>SAR-2629</b>	300 x 150 x 60 mm
<b>SAR-2630</b>	300 x 200 x 50 mm
<b>SAR-2631</b>	350 x 250 x 50 mm
<b>SAR-2632</b>	400 x 200 x 100 mm
<b>SAR-2633</b>	450 x 250 x 50 mm



**Kidney Tray**  
 SAR-2634 160 mm  
 SAR-2635 200 mm  
 SAR-2636 250 mm  
 SAR-2637 280 mm  
 SAR-2638 300 mm



**Kidney Tray Shallow**  
 SAR-2639 170 mm  
 SAR-2640 220 mm  
 SAR-2641 240 mm



**Kidney Tray With Cover**  
 SAR-2642 160 mm  
 SAR-2643 200 mm  
 SAR-2644 250 mm  
 SAR-2645 280 mm  
 SAR-2646 300 mm



**Kidney Tray**  
 SAR-2647 160 mm  
 SAR-2648 200 mm  
 SAR-2649 250 mm  
 SAR-2650 280 mm  
 SAR-2651 300 mm



**Forceps Jars**  
 SAR-2652 30 x 90 mm  
 SAR-2653 50 x 100 mm  
 SAR-2654 50 x 130 mm  
 SAR-2655 50 x 175 mm  
 SAR-2656 75 x 100 mm  
 SAR-2657 75 x 130 mm  
 SAR-2658 75 x 175 mm  
 SAR-2659 100 x 175 mm  
 SAR-2660 100 x 200 mm



**Methot Jar Without Lid**  
 SAR-2661



**Dressing Jar / Cotton Container**  
 SAR-2662 80 x 80 mm  
 SAR-2663 100 x 60 mm  
 SAR-2664 100 x 80 mm  
 SAR-2665 100 x 100 mm  
 SAR-2666 120 x 80 mm  
 SAR-2667 120 x 100 mm  
 SAR-2668 150 x 100 mm  
 SAR-2669 150 x 150 mm  
 SAR-2670 180 x 150 mm  
 SAR-2671 180 x 180 mm  
 SAR-2672 200 x 200 mm  
 SAR-2673 240 x 240 mm



**Dressing Jar With Lid & Knob**  
 SAR-2675 80 x 80 mm  
 SAR-2676 90 x 90 mm  
 SAR-2677 100 x 100 mm  
 SAR-2678 120 x 120 mm  
 SAR-2679 100 x 130 mm  
 SAR-2680 150 x 150 mm  
 SAR-2681 125 x 170 mm



**Sputum Cup**  
 SAR-2674



**Round Bowls**  
 SAR-2682 80 x 35 mm  
 SAR-2683 125 x 60 mm



Spirit Lamp  
SAR-2684



Spirit Lamp  
SAR-2685



Spirit Lamp  
SAR-2686



Cotton Holding Jar  
SAR-2687



Cotton Holder  
SAR-2688



Cotton Holder  
SAR-2689



Cotton Wool Dispenser Acc.  
to Methot  
SAR-2690



Needle Sterillization Tub  
SAR-2691



Round Endodontic Boxes  
complete with lid  
SAR-2692 Ø mm. 94 - h. mm. 70



Endodontic Box  
SAR-2693

# HOLLOWWARE INSTRUMENTS



**SAR-2694**  
100 x 180 x 11mm  
Mini size



**SAR-2695**  
100 x 180 x 11mm  
Mini size



**SAR-2696**  
100 x 180 x 11mm  
Mini size



**SAR-2697**  
100 x 180 x 11mm  
Mini size

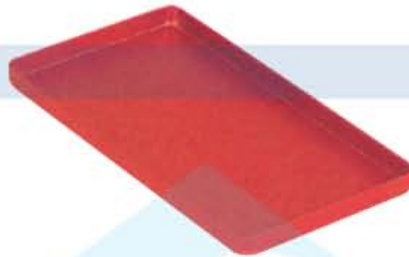

**SAR-2698**  
100 x 180 x 11mm  
Mini size



Lid  
Coperchio

**SAR-2699**  
103 x 182 x 10mm  
Mini size



**SAR-2700**  
Silver



**SAR-2701** Blue  
**SAR-2702** Red



**SAR-2703** Blue  
**SAR-2704** Red



**SAR-2705**  
Silver



**SAR-2706**  
Green



**SAR-2708**  
Blue



**SAR-2707**  
Golden



**SAR-2709**  
Red



**SAR-2710**  
Silver



**SAR-2711**  
Midi  
125 x 105 x 54mm



**SAR-2712**  
Maxi  
204 x 105 x 54mm

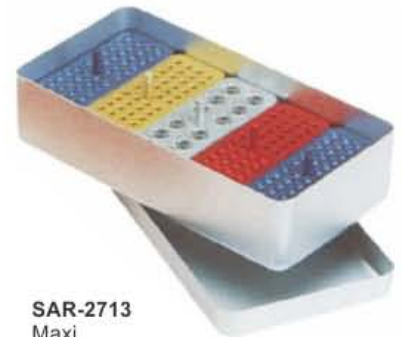

**SAR-2713**  
Maxi  
204 x 105 x 54mm



### Round Sterilizer Drum

<b>SAR-2714</b>	mm. Ø 80 x 80 H
<b>SAR-2715</b>	mm. Ø 125 x 80 H
<b>SAR-2716</b>	mm. Ø 125 x 100 H
<b>SAR-2717</b>	mm. Ø 125 x 125 H
<b>SAR-2718</b>	mm. Ø 150 x 80 H
<b>SAR-2719</b>	mm. Ø 150 x 100 H
<b>SAR-2720</b>	mm. Ø 150 x 130 H
<b>SAR-2721</b>	mm. Ø 150 x 150 H
<b>SAR-2722</b>	mm. Ø 150 x 190 H
<b>SAR-2723</b>	mm. Ø 190 x 125 H
<b>SAR-2724</b>	mm. Ø 190 x 145 H
<b>SAR-2725</b>	mm. Ø 190 x 165 H
<b>SAR-2726</b>	mm. Ø 190 x 190 H
<b>SAR-2727</b>	mm. Ø 190 x 240 H
<b>SAR-2728</b>	mm. Ø 190 x 290 H
<b>SAR-2729</b>	mm. Ø 240 x 120 H
<b>SAR-2730</b>	mm. Ø 240 x 145 H
<b>SAR-2731</b>	mm. Ø 240 x 165 H
<b>SAR-2732</b>	mm. Ø 240 x 190 H
<b>SAR-2733</b>	mm. Ø 240 x 240 H
<b>SAR-2734</b>	mm. Ø 240 x 290 H
<b>SAR-2735</b>	mm. Ø 240 x 340 H
<b>SAR-2736</b>	mm. Ø 240 x 390 H
<b>SAR-2737</b>	mm. Ø 290 x 145 H
<b>SAR-2738</b>	mm. Ø 290 x 165 H
<b>SAR-2739</b>	mm. Ø 290 x 190 H
<b>SAR-2740</b>	mm. Ø 290 x 240 H
<b>SAR-2741</b>	mm. Ø 290 x 290 H
<b>SAR-2742</b>	mm. Ø 290 x 340 H
<b>SAR-2743</b>	mm. Ø 290 x 390 H
<b>SAR-2744</b>	mm. Ø 340 x 145 H
<b>SAR-2745</b>	mm. Ø 340 x 165 H
<b>SAR-2746</b>	mm. Ø 340 x 190 H
<b>SAR-2747</b>	mm. Ø 340 x 240 H
<b>SAR-2748</b>	mm. Ø 340 x 290 H
<b>SAR-2749</b>	mm. Ø 340 x 340 H
<b>SAR-2750</b>	mm. Ø 340 x 390 H
<b>SAR-2751</b>	mm. Ø 390 x 140 H
<b>SAR-2752</b>	mm. Ø 390 x 165 H
<b>SAR-2753</b>	mm. Ø 390 x 190 H
<b>SAR-2754</b>	mm. Ø 390 x 240 H
<b>SAR-2755</b>	mm. Ø 390 x 290 H
<b>SAR-2756</b>	mm. Ø 390 x 340 H
<b>SAR-2757</b>	mm. Ø 390 x 390 H
<b>SAR-2758</b>	mm. Ø 390 x 490 H



### Round Sterilizer Drums "Filter"

<b>SAR-2759</b>	mm. Ø 80 x 80 H
<b>SAR-2760</b>	mm. Ø 125 x 80 H
<b>SAR-2761</b>	mm. Ø 125 x 100 H
<b>SAR-2762</b>	mm. Ø 125 x 125 H
<b>SAR-2763</b>	mm. Ø 150 x 100 H
<b>SAR-2764</b>	mm. Ø 150 x 130 H
<b>SAR-2765</b>	mm. Ø 150 x 150 H
<b>SAR-2766</b>	mm. Ø 150 x 190 H
<b>SAR-2767</b>	mm. Ø 190 x 145 H
<b>SAR-2768</b>	mm. Ø 190 x 165 H
<b>SAR-2769</b>	mm. Ø 190 x 190 H
<b>SAR-2770</b>	mm. Ø 190 x 240 H
<b>SAR-2771</b>	mm. Ø 240 x 145 H
<b>SAR-2772</b>	mm. Ø 240 x 165 H
<b>SAR-2773</b>	mm. Ø 240 x 190 H
<b>SAR-2774</b>	mm. Ø 240 x 240 H
<b>SAR-2775</b>	mm. Ø 240 x 290 H
<b>SAR-2776</b>	mm. Ø 240 x 340 H
<b>SAR-2777</b>	mm. Ø 240 x 390 H
<b>SAR-2778</b>	mm. Ø 290 x 145 H
<b>SAR-2779</b>	mm. Ø 290 x 165 H
<b>SAR-2780</b>	mm. Ø 290 x 190 H
<b>SAR-2781</b>	mm. Ø 290 x 240 H
<b>SAR-2782</b>	mm. Ø 290 x 290 H
<b>SAR-2783</b>	mm. Ø 290 x 340 H
<b>SAR-2784</b>	mm. Ø 290 x 390 H
<b>SAR-2785</b>	mm. Ø 340 x 145 H
<b>SAR-2786</b>	mm. Ø 340 x 165 H
<b>SAR-2787</b>	mm. Ø 340 x 190 H
<b>SAR-2788</b>	mm. Ø 340 x 240 H
<b>SAR-2789</b>	mm. Ø 340 x 290 H
<b>SAR-2790</b>	mm. Ø 390 x 140 H
<b>SAR-2791</b>	mm. Ø 390 x 165 H
<b>SAR-2792</b>	mm. Ø 390 x 190 H
<b>SAR-2793</b>	mm. Ø 390 x 240 H
<b>SAR-2794</b>	mm. Ø 390 x 290 H
<b>SAR-2795</b>	mm. Ø 390 x 340 H
<b>SAR-2796</b>	mm. Ø 390 x 490 H



### Round Bowls With Cover

<b>SAR-2797</b>	Ø 40 mm ml.30
<b>SAR-2798</b>	Ø 60 mm ml.50
<b>SAR-2799</b>	Ø 80 mm ml.150
<b>SAR-2800</b>	Ø 100 mm ml.250
<b>SAR-2801</b>	Ø 120 mm ml.450
<b>SAR-2802</b>	Ø 150 mm ml.750
<b>SAR-2803</b>	Ø 180 mm ml.1500
<b>SAR-2804</b>	Ø 200 mm ml.2100
<b>SAR-2805</b>	Ø 250 mm ml.3500

### Round Bowls With Out Cover

<b>SAR-2806</b>	Ø 40 mm ml.30
<b>SAR-2807</b>	Ø 60 mm ml.50
<b>SAR-2808</b>	Ø 80 mm ml.150
<b>SAR-2809</b>	Ø 100 mm ml.250
<b>SAR-2810</b>	Ø 120 mm ml.450
<b>SAR-2811</b>	Ø 150 mm ml.750
<b>SAR-2812</b>	Ø 180 mm ml.1500
<b>SAR-2813</b>	Ø 200 mm ml.2100
<b>SAR-2814</b>	Ø 250 mm ml.3500

## INSTRUMENTS MANAGEMENT SYSTEM

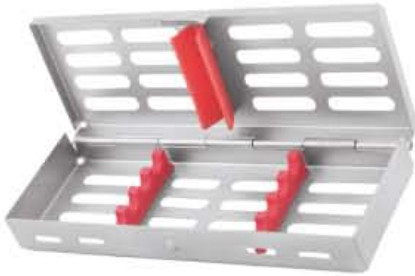

Cassette For 4 Instruments  
SAR-2815



Cassette For 5 Instruments  
SAR-2816



Cassette For 6 Instruments  
SAR-2817



Cassette For 7 Instruments  
SAR-2818



Cassette For 10 Instruments  
SAR-2819

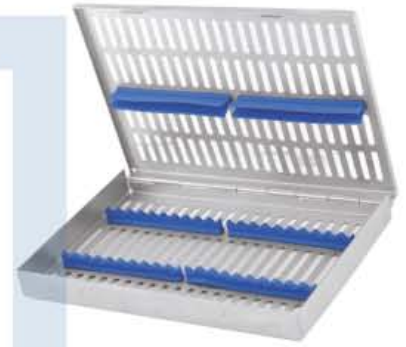

Cassette For 20 Instruments  
SAR-2820



Cassette For Extraction Forceps  
SAR-2821



Cassette For Root Elevator  
SAR-2822



SAR-2823  
Cassette Tray  
15 Pcs



SAR-2824  
Cassette Tray  
15 Pcs

# HOLLOWARE INSTRUMENTS

## STERILIZING MESH TRAY

Different sizes & dimensions are available at buyer's demand



**MESH TRAYS**  
**SAR-2825**  
Different sizes & dimensions are available at buyer's demand



**MESH TRAYS**  
**SAR-2826**  
05 Pcs



**MESH TRAYS**  
**SAR-2827**  
07 Pcs



**MESH TRAYS**  
**SAR-2828**  
10 Pcs



**MESH TRAYS**  
**SAR-2829**  
20 Pcs



**SAR-2830**  
Mesh Cassettes  
5 Pieces, 7 Pieces, 10 Pieces,  
15 Pieces & 20 Pieces

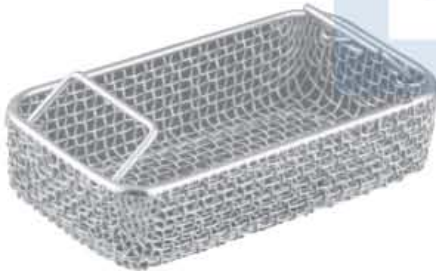

**MESH TRAY**  
SAR-2831 240x130x50mm  
SAR-2832 240x130x60mm  
SAR-2833 240x250x50mm  
SAR-2834 240x250x60mm  
SAR-2835 480x250x50mm  
SAR-2836 480x250x60mm  
SAR-2837 480x250x70mm



**MESH TRAY**  
SAR-2838 240x250x 50mm  
SAR-2839 240x250x 60mm  
SAR-2840 240x250x 70mm  
SAR-2841 480x250x 50mm  
SAR-2842 480x250x 60mm  
SAR-2843 480x250x 70mm  
SAR-2844 480x250x100mm



**MESH TRAY**  
SAR-2845 240x250x50mm  
SAR-2846 240x250x60mm  
SAR-2847 240x250x70mm  
SAR-2848 280x250x50mm  
SAR-2849 280x250x60mm



**MESH TRAY**  
SAR-2850 280x250x 70mm  
SAR-2851 280x250x100mm  
SAR-2852 280x250x 50mm  
SAR-2853 280x280x 60mm  
SAR-2854 280x280x 70mm  
SAR-2855 300x280x 60mm



# HOLLOWARE INSTRUMENTS



**SAR-2856**  
18×7×3.5cm  
5 Instruments Cassette  
Detachable Lids  
+  
5 Instruments Cassette Hinged  
Lids with button Lock



**SAR-2857**  
29×18.5×3.5cm  
20 Instruments Cassette Hinged  
Lids with surgical kit fitting,  
button lock



**Instruments Cassette**  
**SAR-2858** 5 Pieces Cassette  
**SAR-2859** 7 Pieces Cassette  
**SAR-2860** 10 Pieces Cassette



**SAR-2861**  
18×11×3.5cm  
Extra large cassette for 6  
Instruments, with compartment  
for small parts hinged lids



**SAR-2862**  
29×18.5×3.5cm  
20 Instruments Cassette  
Detachable Lids  
+  
20 Instruments Cassette Hinged  
Lids with button Lock

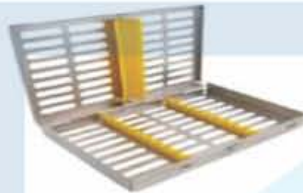

**SAR-2863**  
10×13×2.2cm  
10 Instruments Cassette Hinged  
Lids, Click Lock Available in 2  
designs



**SAR-2864**  
29×18.5×3.5cm  
20 Instruments Cassette Detachable  
Lids with elevator fitting  
+  
20 Instruments Cassette Hinged  
Lids with elevator fitting , button lock



**SAR-2865**  
18×9×2.2cm  
7 Instruments Cassette Hinged  
Lids, Click Lock, Available in 2  
designs



**SAR-2866**  
21×14×3.5cm  
15 Instruments cassette,  
Detachable lids, button lock



**SAR-2867**  
21×14×3.5cm  
15 Instruments cassette,  
detachable lids, button  
lock, with fitting of micro  
surgery kit



**SAR-2868**  
21×14×4.5cm  
8 pcs luxator/elevator  
cassette, Detach0  
ablelids, button lock



**SAR-2869**  
15×9×5cm  
Box for dental implant tools and  
surgical kits, Capacity:8  
tools, 18 tools, 24 Tools, 58 Tools  
+ removable compartment



**Instruments Tray Perforated**  
**SAR-2870** 288 x 187 x 40 mm



**Instruments Tray Perforated Base**  
**SAR-2871** 288 x 187 x 40 mm



**Instruments Tray Solid Base**  
**SAR-2872** 288 x 187 x 40 mm



**SAR-2873** Implant Basic Starter Kit 11 instruments with case



**SAR-2874** Crown Bridge Set Instruments with Case



**SAR-2875** Bone Curettes Spoon Style set of 4 with Metal Case



**SAR-2876** Peritome Set of 2 with Blue Nitrate Tips and Metal Case

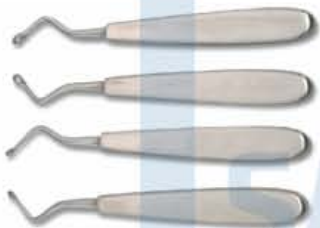

**SAR-2877** Root Fragment Removal elevators, Set of 4 with Metal Case



**SAR-2878** Peritome Set of 3 Gold Handles Serrated Blades with Metal Case





DESCRIPTION PAGE#

**A**

A COSMETIC CONTOURING IMPLANTOLOGY ..... 148

AB1 BOGHOSIAN IMPLANTOLOGY ..... 147

AB2 BOGHOSIAN IMPLANTOLOGY ..... 147

ABDU-RASS EXPLORERS ..... 54

ACUTE IMPLANTOLOGY ..... 161

ADAMS PLIER ..... 133

ADAMS PLIER ROUND BOX ..... 133

ADAMS PLIERS FOR HOOKS AND BENDING ..... 138

ADAMS, SMALL WIRE BENDING AND LOOP FORMING PLIERS ..... 132

ADERER CLAMP THREE JAW WIRE BENDING PLIER ..... 138

ADERER FACEBOW LOOP FORMING PLIERS ..... 134

ADERER LARGE WIRE BENDING AND LOOP FORMING PLIERS ..... 133

ADERER PLIER ..... 134

ADHESIVE REMOVING PLIERS ..... 36,141

ADSON 7X7 CURVED TISSUE FORCEPS ..... 169

ADSON BROWN TWEEZERS ..... 53

ADSON CARBIDE TIPPED TISSUE FORCEPS ..... 169

ADSON NEEDLE HOLDERS ..... 107

ADSON-TC TWEEZERS ..... 53

ADULT PALATAL DENTAL PHOTOGRAPHIC MIRRORS ..... 98

ALLIS HAEMOSTATIC FORCEPS ..... 110

ALLIS-BABY HAEMOSTATIC FORCEPS ..... 110

ALL-PURPOSE PLIERS ..... 109

ALUMINIUM CALIPER ..... 127

ALM RETRACTOR ..... 102

AMALGAM CARRIERS ..... 117

AMALGAM INSTRUMENTS ..... 116,117

AMALGAM WELL ..... 115,117

ANATOMIC HANDLE EXPLORERS ..... 54

ANDREWS FILLING INSTRUMENTS ..... 87

ANGLE HOW PLIER ..... 139

ANGLED DIRECT BOND BRACKET REMOVER TC ..... 139

ANGLED EXTRACTING FORCEPS FOR UPPER ROOTS ..... 03

ANGLED UTILITY PLIERS ..... 136

ANISWORTH RUBBER DAM CLAMPS FORCEPS ..... 111

ANTERIOR ..... 58

APEX FORCEPS LOWER ROOT DEEP ROOT PICK ..... 06

APEX FORCEPS LOWER UNIVERSAL DEEP ROOT PICK ..... 05

APEXO ROOT ELEVATORS ..... 29

APICAL RETENTION FORCEPS ..... 31,33

APICAL ROOT ELEVATORS ..... 31,33

ARCH BENDING PLIERS ..... 38,143

ARROW CLASP FORMING PLIERS ..... 139

ARTICULATORS ..... 97

ASPIRATING SYRING ..... 27

ATRAUMATIC TWEEZERS ..... 52

ATRAUMATIC WITH LOCK TWEEZERS ..... 52

**B**

BABY TOOTH EXTRACTION FORCEPS SET OF 7 PIECES ..... 08

BACK ACTION FILLING INSTRUMENTS ..... 88

BACKHAUS HAEMOSTATIC FORCEPS ..... 110

BACKHAUS TOWEL CLAMPS ..... 110

BACOLITE HANDLE WAX KNIVES ..... 96

BALL BURNISHERS ..... 71

BALL FILLING INSTRUMENTS ..... 93

BALL SOCKET NOT-PERFORATING AND NOT-DAMAGING ..... 110

BALLACORN FILLING INSTRUMENTS ..... 88

BAND REMOVING PLIERS ..... 32,138

BAND SEATER AUTO CLEAVABLE ..... 129

BAND SEATER AUTO CLEAVABLE ROUND SHAPE ..... 129

BAND SEATER AUTO CLEAVABLE SQUARE SHAPE ..... 129

BAND SEATER AUTO CLEAVABLE TRIANGLE SHAPE ..... 129

BAND SEATING & REMOVING INSTRUMENTS ..... 129

BAND SEATING & REMOVING SILICON GRIP ..... 129

BAND SEATING PLIERS ..... 141

BANDS & CROWNS PLIER ..... 134

BARRAQUER TC NEEDLE HOLDERS ..... 109

BASINS FOR BONE ..... 174

BAUMGARTNER NEEDLE HOLDERS ..... 06,107

BAYONET ROOTS ELEVATOR SET ..... 36

BEAVERTAIL FILLING INSTRUMENTS ..... 88

BEEBEE GUM SCISSORS ..... 106

BEERENDONK CALIPER ..... 127

BEIN ROOT ELEVATORS ..... 29,40

BENDING PLIER ..... 138

BESEK COMPOSITE INSTRUMENTS ..... 72

BESEK COMPOSITE MODELLING INSTRUMENTS ..... 85

BESEK COMPOSITE PLUGGERS INSTRUMENTS ..... 82

BESEK PLUGGERS ..... 76

BEYER BONE ROUNDER ..... 25

BINANGLE SCALER ..... 67

BIRD BEAK PLIER ..... 38,141

BIRD BEAK PLIER FOR BENDING ..... 138

BIRD BEAK PLIER STANDARD ..... 133

BIRD BEAK WIRE BENDING & CUTTING PLIERS ..... 134

BIRD BEAK WIRE BENDING PLIER ..... 133

BISHOP RETRACTORS ..... 101

BLACK FILLING INSTRUMENTS ..... 80,87

BLACK SCALER ..... 66

BLACK TITANIUM COLOUR COATED INSTRUMENTS ..... 147,148,149

BLADE AND PUSHER ..... 166

BLUE TITANIUM COATED BONE GRAFTING INSTRUMENTS ..... 59,187

SET OF 7 PCS WITH CASSETTE ..... 159

BLUMENTHAL BONE ROUNDER ..... 25

BOLEY GAUGE ..... 127

BONE BRACKET GAUGE ..... 125

BONE CARRIER TITANIUM ..... 165

BONE CRUSHER ..... 174

BONE CRUSHER TITANIUM METAL CUTTER ..... 174

BONE EXPANDER KIT ..... 176

BONE EXPANDER SCREW & SURGICAL KITS ..... 176

BONE FILES ..... 119

BONE GRAFT ..... 159

BONE GRAFT IMPLANTOLOGY ..... 156

BONE GRAFT PACKER ..... 164

BONE GRAFT/CARRIER TITANIUM ..... 167

BONE GRAFTING INSTRUMENTS COMPACTOR /TAMPERS ..... 166

BONE INJECTORS, COLLECTORS & SUCTION TUBE ..... 175

BONE MILL ..... 174

BONE ROUNDER ..... 25

BONE SCRAPER ..... 173

BONE SCRAPER STRAIGHT & CURVED ..... 173

BONE SPOON/ PACKER ..... 168

DESCRIPTION PAGE#

BONE THICKNESS GAUGE ..... 146

BONE UNIVERSAL KIT ..... 176

BONE WELL ..... 174

BOX FOR DENTAL IMPLANT TOOLS AND SURGICAL KITS ..... 191

BOX JOINT PLIERS ..... 132,133,134

BRACKET HOLDER TWEEZERS ..... 128

BRACKET PLACER TWEEZERS ..... 128

BRACKET PLACING TWEEZERS ..... 128

BRACKET REMOVING PLIER CURVED ..... 132

BRACKET REMOVING PLIER ROUND BOX ..... 132

BRACKET REMOVING PLIERS ANGLED ..... 136

BRACKET REMOVING PLIERS STRAIGHT ..... 136

BRACKET REMOVING PLIERS WITH PLASTIC TIP ..... 136

BRACKET TWEEZERS SLOT ALIGNER ..... 128

BREWER RUBBER DAM CLAMPS FORCEPS ..... 111

BREUNINGS RETRACTORS ..... 101

BUCCAL AND LINGUAL/PALATAL SCALER ..... 61

BUCCAL DENTAL PHOTOGRAPHIC MIRRORS ..... 98

BUCCAL SURFACES SCALER ..... 61

BUCCAL-SMALL DENTAL PHOTOGRAPHIC MIRRORS ..... 98

BURNISHER FILLING INSTRUMENTS ..... 78,88

BURNISHERS ..... 98

BURNISHERS CONSERVATIVE TREATMENT ..... 149

BUSER PERIODONTAL INSTRUMENTS ..... 121

**C**

COSMETIC CONTOURING IMPLANTOLOGY ..... 148

CARBIDE DIAMOND COATED POINT ..... 24

CARRY FORCEPS ..... 170

CARVER COMPOSITE MODELLING INSTRUMENTS ..... 85

CARVERS INSTRUMENTS ..... 89,90

CARVERS INSTRUMENTS CASSETTE FOR 5 INSTRUMENTS ..... 80

CASSETTE FOR INSTRUMENTS ..... 162

CASTROVIEJO CALIPERS ..... 126

CASTROVIEJO GUM SCISSORS ..... 105

CASTROVIEJO MICRO SCISSORS ..... 108

CASTROVIEJO NEEDLE HOLDERS ..... 107,109

CATHETERS TRAY WITH LID BOX WITH FILTER ..... 184

CATRIDGE SYRING ..... 27

CEMENT SPATULAS ..... 95

CERI SAW ..... 124

CHEEK RETAINER ..... 101

CHILD PALATAL DENTAL PHOTOGRAPHIC MIRRORS ..... 98

CHIP BLOWER ..... 116

CHISELS, BONE FILES & SPOONE CURETTE ..... 118

CHISELS SCALER ..... 65,67

CHOMPRET ROOT ELEVATOR ..... 42

CINCH BACK / TIE BACK DISTAL END BENDING PLIERS ..... 137

CLAW-LIFT ROOTS ELEVATOR ..... 37

COARSE SUCTION TUBES ..... 178

COBRA IMPLANTOLOGY ..... 156

COHEN UNIVERSAL EXTRACTING FORCEPS (AMERICAN PATTERN) ..... 17

COLLEGE FORCEPS ..... 51

COLLEGE TWEEZER ..... 53

COLLEGE WITH LOCK TWEEZERS ..... 52

COLLINS TONGUE FORCEPS ..... 110

COLUMBIA RETRACTOR ..... 99

COMBINATION RETRACTORS ..... 101

COMELLAS FORCEPS ANATOMICAL HANDLE ..... 26

COMPASSO DE WILLIS ..... 127

COMPOSITE BALL PLUGGERS ..... 76

COMPOSITE FILLING INSTRUMENTS ..... 92,93

COMPOSITE FILLING INSTRUMENTS SET OF 6 PCS ..... 93

COMPOSITE GOLD TIP INSTRUMENTS ..... 72,73

COMPOSITE INSTRUMENTS ..... 89

COMPOSITE INSTRUMENTS BLUE TITANIUM WITH CASSETTES ..... 89

COMPOSITE INSTRUMENTS TITANIUM BLUE ENDOODONTIC ..... 85

COMPOSITE MODELLING INSTRUMENTS ..... 82,83

COMPOSITE PLUGGERS INSTRUMENTS ..... 87

COMPOSITE/PLASTIC FILLING INSTRUMENTS ..... 150,161

CONDENSER IMPLANTOLOGY ..... 49

CONE-SOCKET MOUTH MIRRORS ..... 49

CONE-SOCKET FRONT SURFACE MOUTH MIRRORS ..... 50

CONE-SOCKET MIRROR HANDLES FOR MOUTH MIRRORS ..... 49

CONE-SOCKET PLAIN MOUTH MIRRORS ..... 49

CONE-SOCKET RHODIUM MOUTH MIRRORS ..... 49

CONE-SOCKET SOLID HANDLES FOR MOUTH MIRRORS ..... 50

CONE-SOCKET SOLID OCTAGONAL HANDLES FOR MOUTH MIRRORS ..... 50

CONTOURING PLIER ..... 134,138

COPERCHO HOLLOWARE INSTRUMENTS ..... 145

CORROSION-RESISTANT ..... 186

COTTON HOLDER ..... 186

COTTON HOLDING JAR ..... 186

COTTON WOOL DISPENSER ACC. TO METHOD ..... 186

COUPLAND ROOT ELEVATORS ..... 34

CRANE KAPLAN TWEEZERS ..... 53

CRILE-WOOD NEEDLE HOLDERS ..... 105,107

CROWN REMOVER ..... 114

CROWN SPREADERS ..... 114

CRUCIBLE TONGS ..... 124

CRUYER EXTRACTING FORCEPS (AMERICAN PATTERN) ..... 12,13,19,20

CRUYER ROOT ELEVATORS ..... 32

CUTTER ..... 139,142

CUTTER, UTILITY PLIERS & WIRE FORMING PLIERS ..... 141

**D**

DEAN GUM SCISSORS ..... 105

DEBAKEY ATRAUMATIC TISSUE FORCEPS ..... 169

DELUX BOLEY GAUGE ..... 127

DELUXE BRACKET HOLDER ..... 128

DELUXE BRACKET HOLDER TWEEZERS ..... 128

DENHARD RETRACTORS - MOUTH GAGS ..... 100

DENTAL PHOTOGRAPHIC MIRRORS ..... 98

DENTAL SYRINGES ..... 27

DENTAURUM CALIPER ..... 127

DERF NEEDLE HOLDERS ..... 106,107

DETAILING STEP PLIER ..... 139

DETAILING STEP PLIERS / BAYONET BENDING PLIERS ..... 137

DIAMOND COATED MARGIN TRIMMERS ..... 65

DIRECT BOND BRACKET HOLDER TWEEZERS ..... 126

DIRECT BOND BRACKET HOLDER TWEEZERS, SMALL TIP ..... 126

DIRECT BONDING BRACKET HOLDERS ..... 128

DIRECT BRACKET REMOVER TC ..... 140

DISC SYSTEM DENTAL SYRINGES ..... 27

DISSECTING SET SET OF 11 PCS ..... 94

DISSECTING SET SET OF 9 PCS ..... 94

## DESCRIPTION PAGE#

DISTAL AMALGAM CARRIERS	117
DISTAL BENDER SILICON GRIP	129
DISTAL CUTTER	139
DISTAL END CUTTER	135
DISTAL END CUTTER FLUSH CUT	142
DISTAL END CUTTER, SAFETY HOLD PLIER (IDEAL FOR CUTTING WIRE) TC	140
DISTAL END WIRE CUTTERS & BRACKET REMOVER PLIERS	140
DISTAL SCALER	61,63
DOUBLE ENDED CEMENT SPATULA	131
DOUBLE ROUNDED JAW BENDING PLIERS	138
DOUBLE-ENDED EXPLORERS	54
DRESSING TWEEZERS	52,53
DYNAMOMETER	146

<b>E</b>	
EASY ACCESS TWEEZERS	128
EBNETER SCALER	64
ELASTIC INSTRUMENT SILICON GRIP	129
ELASTIC SEPARATING PLIER	140
ELASTIC SEPARATING PLIER ROUND HANDLE	140
ELASTOMERIC LIGATURE PLACING FORCEPS WITH GROOVE FALCON	140
ELEVATORS SET OF 8 PCS	46
ELEVATORS SET OF 8 PCS	46
ELLIOT SIQVELAND RETAINERS	115
ENDO FINGER RULER SPAN MEASURE SCALE	125
ENDODONTIC BOX	196
ENDODONTIC EXPLORER	154
ENDODONTICS INSTRUMENTS	58
ERGO GRIP RETRACTOR	101
EURO BREECH LOADING DENTAL SYRINGES	27
EXAVATORS EXPLORERS	51
EXCAVATOR INSTRUMENTS	74
EXCAVATORS	86
EXECT BRACKET HOLDER TWEEZERS	128
EXPLORERS	51,54,55,56
EXTRACTING FORCEPS (AMERICAN PATTERN)	129a,24
EXTRACTING FORCEPS (ENGLISH PATTERN)	011a07,26

EXTRACTING FORCEPS (ENGLISH PATTERN) SET OF 10 PIECES	07
EXTRACTING FORCEPS	08
EXTRACTING FORCEPS AMERICAN ADULT SET OF 10 PCS	28
EXTRACTING FORCEPS AMERICAN ADULT SET OF 8 PCS	28
EXTRACTING FORCEPS CHILDREN PATTERN SET OF 10 PIECES	28
EXTRACTING FORCEPS ENGLISH ADULT SET OF 10 PCS	28
EXTRACTING FORCEPS PEDO SET OF 7 PCS	28
EXTRACTING FORCEPS SET	28
EXTRACTING FORCEPS SET OF 10 PIECES	28
EXTRACTING FORCEPS SET OF 10 PIECES	28
EXTRACTING FORCEPS SET OF 13 PIECES	28
EXTRA-FLEX IMPLANTOLOGY	147

<b>F</b>	
FALCON BEAK CONTOURING PLIERS	133,138
FARABEUF RETRACTORS SET OF 2 PIECES)	103
FELDMAN RETRACTOR	103
FILLING INSTRUMENTS (GOLD POINTED)	91
FILLING INSTRUMENTS	87,88,91,93
FILLING INSTRUMENTS CONSERVATIVE TREATMENT	89,70,75,78,79,81,84
FIRST AID EXAMINATION SET OF 3 PIECES	51
FLEXIBLE PERIOME	163
FLEX-THIN IMPLANTOLOGY	147
FLOHR ROOT ELEVATORS	29,33
FLUSH-CUT DISTAL AND CUTTING PLIERS	133
FLUSH-CUT DISTAL END CUTTER	135
FOERSTER DRESSING FORCEPS	110
FRAZIER SUCTION TUBES WITH FILTER	178
FREEDMAN 'DUCKHEAD'	149
FREEDMAN BURNSHERS	149
FREEDMAN LARGE CONTACT FORMING	149
FREEDMAN SMALL CONTACT FORMING	149
FREER PERIODONTAL INSTRUMENTS	121
FREER PERIOSTEEL ELEVATORS	120
FRET SAW	124
FRIEDMAN BONE ROUNDER	25
FRIEDMANN ROOT ELEVATOR	36
FRIEDMANNRICHARD PERIODONTAL INSTRUMENTS	122
FUZZI COMPOSITE MODELLING INSTRUMENTS	85

<b>G</b>	
GERALD TWEEZERS	52
GILLES TWEEZERS	52
GILLES NEEDLE HOLDER WITH SCISSORS	107
GLOVES BOX	184
GOLD COLOR SET DENTAL ORAL IMPLANTOLOGY SINUS SET OF 10 PCS WITH CASSETTE	156
GOLD MILL (LARGE)	174
GOLD MILL (SMALL)	174
GOLDMAN FOX SUPER CUT SCISSORS	108
GOLDMAN FOX EXPLORERS	55
GOLDMAN FOX SCISSORS	108
GOLDMAN-FOX GUM SCISSORS	104,105
GOLDMAN-FOX PERIODONTAL INSTRUMENTS	121
GOLDMANN-FOX SCALER	64
GRACEY AFTER FIVE	60
GRACEY CURETTES SCALER	61
GRACEY CURETTES	59,63
GRACEY MINI FIVE	60
GRACEY SCALER	61
GRAFT MATERIAL SPOON CONCAVE TIP FOR LARGER GRAFTS	165
GRAFT PACKER	166
GRAFT PACKER, CONCAVE	166
GRIPPER CARBIDE TIPPED TISSUE FORCEPS TC	169
GRITMAN CEMENT SPATULAS	95
GROSS MAIER DRESSING FORCEPS	110
GULDENER SCALER	64
GUM SCISSORS	104b,108

<b>H</b>	
HAEMOSTATIC FORCEPS & TOWEL CLAMPS	110
HALSEY NEEDLE HOLDERS	106,107
HALSTEAD MOSQUITO HAEMOSTATIC FORCEPS	110
HALSTEAD MOSQUITO NEEDLE HOLDERS	107
HALTEPINZETTE WITH LOCK TWEEZERS	170

## DESCRIPTION PAGE#

HAMMER HEAD DISTAL END BENDING PLIERS	137
HAMMER WITH WOODEN HANDLE	124
HANDLE ROUND HANDLES FOR MOUTH MIRRORS	50
HANDLES FOR MOUTH MIRRORS	50
HARD WIRE CUTTER	142
HARD WIRE CUTTER STRAIGHT	142
HARD WIRE CUTTER, 15° ANGLED	135
HARD WIRE CUTTER, 15° ANGLED NON-AUTOCALAVABLE	135
HARD WIRE CUTTER, STRAIGHT	140
HARD WIRE CUTTERS	140
HARRIS EXTRACTING FORCEPS (AMERICAN PATTERN)	13,18
HARTMANN (BABY MOSQUITO) NEEDLE HOLDERS	107
HEAT CARRIERS	57
HEBER BAYONET ROOTS ELEVATOR	40
HEBER ROOTS ELEVATOR	40
HEIDBRINK ROOT APPEX ELEVATOR	44
HEIDBRINK ROOT ELEVATORS	33,43
HEIDBRINK ROOTS ELEVATOR WARWICK-JAMES	44
HEIDEMANN FILLING INSTRUMENTS	93
HEIDEMANN SPATULAS	73
HEIGHT GAUGE 0.16 STAINLESS STEEL	125
HEIGHT GAUGE ALUMINIUM	125
HEMINGWAY TWEEZERS	53
HEX TORQUE WRENCH UNIVERSAL	177
HEXAGONAL HANDLES FOR MOUTH MIRRORS	50
HIRSCHFELD PERIODONTAL INSTRUMENTS	122
HIRT COMPOSITE MODELLING INSTRUMENTS	85
HIRT COMPOSITE PLUGGERS INSTRUMENTS	83
HIRT SCALER	66
HMG HEISTER	99
HOLLENBACK FILLING INSTRUMENTS	80,87
HOLLOW CHOP CONTOURING PLIERS	143
HOLLOW HANDLES FOR MOUTH MIRRORS	50
HOLLOW MIRROR HANDLES FOR MOUTH MIRRORS	50
HOLLOWWARE INSTRUMENTS	183,184,186,187,190,191
HOLZ SCALER	65
HOOK CRIMPING PLIER ANGLED STRAIGHT TC	140
HOOK KNIVES	96
HOPSON FILLING INSTRUMENTS	78
HOW PLIER	132
HOW PLIER CURVED	132
HOW PLIERS OFFSET	141
HOW PLIERS STRAIGHT	141
HOW STRAIGHT UTILITY PLIERS	136
HOWARD PERIOSTEEL ELEVATORS	120
HULL EXTRACTING FORCEPS (AMERICAN PATTERN)	19
HYLIN CEMENT SPATULAS	95
HYLIN ROOTS ELEVATOR	39

<b>I</b>	
IMPLANT GAGES	145
IMPLANT SINUS LIFT INSTRUMENTS	161,162
IMPLANTOLOGY	145b,178
IMPLANTOLOGY 9 PCS OF SET	161
IMPLANTOLOGY SET OF 2 COMPOSITE BLUE TIP INSTRUMENTS	154
IMPLANTOLOGY SET OF 3 COMPOSITE BLUE TIP INSTRUMENTS	154
IMPLANTOLOGY SET OF 4 COMPOSITE BLUE TIP INSTRUMENTS	154
IMPLANTOLOGY SET OF 5 COMPOSITE GOLD TIP INSTRUMENTS	154
IMPRESSION TRAYS	179a,182
IMPRESSION TRAYS PERFORATED FULL DENTURE SET OF 8 PCS	181
IMPRESSION TRAYS PERFORATED WITHOUT RIM LOCK	182
IMPRESSION TRAYS SOLID FULL DENTURE SET OF 08 PCS	181
IMPRESSION TRAYS SOLID FULL DENTURE SET OF 8 PCS	182
IMPRESSION TRAYS SOLID WITH RIM LOCK	182
IMPRESSION TRAYS SOLID WITH RIM LOCK SET OF 06 PCS	180
IMPRESSION TRAYS SOLID WITH RIM LOCK SET OF 08 PCS	180
IMPRESSION TRAYS SOLID WITH RIM LOCK SET OF 10 PCS	180
INSTRUMENTS BOX	184
INSTRUMENTS BOX PERFORATED	184
INSTRUMENTS BOX WITH HOOKS	184
INSTRUMENTS BOX WITH LID	184
INSTRUMENTS CASSETTE 10 HINGED	191
INSTRUMENTS CASSETTE 10 PIECES CASSETTE	191
INSTRUMENTS CASSETTE 15 SURGERY KIT	191
INSTRUMENTS CASSETTE	191
INSTRUMENTS CASSETTE 20 DETACHABLE	191
INSTRUMENTS CASSETTE 20 DETACHABLE LIDS	191
INSTRUMENTS CASSETTE 20 HINGED	191
INSTRUMENTS CASSETTE 5 DETACHABLE LIDS	191
INSTRUMENTS CASSETTE 5 HINGED LIDS WITH BUTTON LOCK	191
INSTRUMENTS CASSETTE 5 PIECES CASSETTE	191
INSTRUMENTS CASSETTE 7 HINGED	191
INSTRUMENTS CASSETTE 7 PIECES CASSETTE	191
INSTRUMENTS TRAY PERFORATED	183,191
INSTRUMENTS TRAY PERFORATED BASE	191
INSTRUMENTS TRAY SOLID BASE	191
INSTRUMENTS TRAYS	183
INSTRUMENTS TRAYS WITH COVER	184
INSTRUMENTS TRAYS WITH LID	183
INSTRUMENTS TRAYS WITHOUT COVER	184
INTRALIGAMENTAL ANESTHESIA SYRINGE	27
IRIS GUM SCISSORS	104
IRIS SUPER CUT SCISSORS	104,108
IRIS GUM SCISSORS	104,105,108
IVORY SIQVELAND RETAINERS	115
IVORY LIGHT WEIGHT RUBBER DAM CLAMPS FORCEPS	111
IVORY MATRIX RETAINERS	115
IVORY RETRACTORS	101
IVORY RUBBER DAM CLAMPS FORCEPS	111
WANSON SPRING CALIPER FOR METAL AND PORCELAIN	126
WANSON SPRING CALIPER FOR WAX	126

<b>J</b>	
JAQUETTE SCALER	63
JARABAK PILERS	143
JECT ULTIMA DENTAL SYRINGES	27
JENNINGS RETRACTORS - MOUTH GAGS	100
JOHNSON CONTOURING PLIERS	133
JOHNSON PLIERS FOR CROWN BAND CONTOURING	138
JONES TOWEL CLAMPS	110
JOSEPH GUM SCISSORS	105

<b>K</b>	
KALT NEEDLE HOLDERS TC	109
KELLS EXTRACTING FORCEPS (AMERICAN PATTERN)	15



DESCRIPTION	PAGE#
KELLY GUM SCISSORS	104,105
KELLY HAEMOSTATIC FORCEPS	110
KELLY-RANKIN HAEMOSTATIC FORCEPS	110
KEY RINGS	94
KEYS FOR IMPLANT SCREW	177
KILNER (RAGNELL) GUM SCISSORS	105
KIRKLAND SCALER	64
KLEIN EXTRACTING FORCEPS	08
KLEINERT-KUTZ BONE ROUNDING	25
KOPP ROOTS ELEVATOR	39
KRAMER NEVINS SINUS LIFT	162
KRAMER-NEVINS PERIODONTAL INSTRUMENTS	121
KRARNER-NEVINS BONE CHISEL	119
KUEHNE TWEEZERS	170
<b>L</b>	
LA GRANGE NEEDLE HOLDERS	109
LA GRANGE GUM SCISSORS	104,105
LADMORE FILLING INSTRUMENTS	88
LADMORE IMPLANTOLOGY	149
LAGRANGE SCISSORS	108
LAGRANGE SUPER CUT SCISSORS	108
LANGENBECK RETRACTORS	103
LANGER SCALER	63
LAP & L-KEY JOINT PLIERS	139
LARGE FLUOR-CUT DISTAL AND CUTTING PLIERS	133
LAXUTOR ROOT ELEVATORS	30,31
LAXUTOR ROOT ELEVATORS SET OF 9 PCS	36
LE CRON CEMENT SPATULAS	95
LECLUSE BAYONET ROOT ELEVATOR	41
LESSMANN WAX KNIVES	96
LICHTENBERG-RYDER T.C NEEDLE HOLDERS	109
LIGATURE FORMING PLIERS	134
LIGATURE INSTRUMENT SILICON GRIP	129
LIGHT WORE BIRD BEAK PLIERS WITH GROOVE	143
LINDO LEVIAN ROOT ELEVATORS	35
LINGUAL / PALATAL ARCH FORMING PLIERS	134
LINGUAL ARCH FORMING PLIERS	143
LINGUAL DENTAL PHOTOGRAPHIC MIRRORS	98
LINGUAL/PALATAL SURFACES SCALER	61
LINGUAL-LARGE DENTAL PHOTOGRAPHIC MIRRORS	98
LIP & CHEEK RETRACTOR	100
L-KEY JOINT PLIERS	139to138
LOCKLIN GUM SCISSORS	105
LONDON COLLEGE TWEEZERS	52
LONDON HOSPITAL	34
LONG IMPLANT DRILLS	176
LOOP FORMING IN FOUR LENGTH	138
LORNAHAEMOSTATIC FORCEPS	110
LUCAS IMPLANTOLOGY	168
LUER BONE ROUNDING	25
LUXS	58
LUXATING ELEVATOR / PERIOTOME	36
LUXATING ELEVATOR WITH PERIOTOME TIP	36
LUXATOR ROOT ELEVATORS	29
LUXATOR/ELEVATOR 8 PCS	191
LUXATORS SET OF 7 PCS	46
LUXATORS SET OF 7 PCS	46
LUXATORS SET OF 8 PCS	46
LUXIER ROOTS ELEVATOR	40
LUXIVATORS CURVED ATRAUMATIC LUXATION OF THE TOOTH	48
LUXIVATORS STRAIGHT ATRAUMATIC LUXATION OF THE TOOTH	48
<b>M</b>	
MAGNIFYING MOUTH MIRRORS	49
MALLET IMPLANTOLOGY	174
MALLETS - PLASTER SHEARS - SAWS & BLADES	124
MANUAL ASPIRATING SYRINGE	27
MANUAL CROWN REMOVERS	114
MARGIN TRIMMERS	66
MARGINAL RIDGE & EMBRASURE SHAPING INSTRUMENT	148
MARKLEY FILLING INSTRUMENTS	93
MARQUETTE CONDENSER	87
MARQUETTE PLUGGERS	87
MARYAM TWEEZERS	53
MATHIEU NEEDLE HOLDERS	107
MATRIX RETAINERS	115
MAXI HOLLOWARE INSTRUMENTS	187
MAYO GUM SCISSORS	104
MAYO NEEDLE HOLDERS	106
MAYO TRAY PERFORATED	183
MAYO-HEGAR NEEDLE HOLDERS	108,107
MCCALL SCALER	63
MEAD BONE ROUNDING	25
MEAD NON AUTO CLAVABLE PLASTIC TIPS	119
MEASURING LOOP	126
MEASURING LOOP CASTROVIEJO	126
MEASURING PROBE	145
MEISSNER EXTRACTING FORCEPS	26
MEMBRANE IMPLANTOLOGY	161
MEMBRANE 3POSITIONING IMPLANTOLOGY	150
MEMBRANE DETACH ELEVATOR	164
MEMBRANE ELEVATOR	164
MEMBRANE TWEEZERS	170
MERRIAM TWEEZERS	52
MERRIT B EXPLORERS	55
MERSON BAND PUSHER	129
MESH CASSETTES 5 PIECES, 7 PIECES, 10 PIECES, 15PIECES & 20 PIECES	190
MESH TRAY	190
MESH TRAYS 05 PCS	190
MESH TRAYS 07 PCS	190
MESH TRAYS 10 PCS	190
MESH TRAYS	190
MESH TRAYS 20 PCS	190
MESIAL SCALER	61
METZENBAUM GUM SCISSORS	104,106
MICOR ADSON 1X2 TISSUE FORCEPS	169
MICRO BOLEY GAUGE STRAIGHT	146
MICRO BOLEY GAUGE TWISTED	146
MICRO IRIS GUM SCISSORS	104
MICRO SURGICAL SCALPEL HANDLE TITANIUM	123
MICRO-FRIEDMAN BONE ROUNDING	25
MICRO-MINI PIN & LIGATURE CUTTER	142
MIDDELBOERFP RETRACTORS	103
MILLER BONE FILES	119
MILLER ROOT ELEVATORS	37

DESCRIPTION	PAGE#
MILLER IMPLANTOLOGY	168
MILLER ROOT PLANNING FILES	119
MILLER TWEEZERS	53
MINI DISTAL AMALGAM CARRIERS	117
MINI GAUGE	127
MINI LIGATURE CUTTERS	133
MINI PIN & LIGATURE CUTTER	142
MINI PIN & LIGATURE CUTTER TC	139
MINI-LANGENBECK RETRACTORS	102
MINI-SPATEL BURNISHERS	71
MINNESOTA RETRACTORS	101
MIRROR EXPLORERS	51
MIRROR HANDLE STEM WITH RULE HANDLES FOR MOUTH MIRRORS	50
MISCELLANEOUS PRODUCTS	94
MIXING SPATULA WITH SHOVEL	165
MOLT 9 PERIODONTAL INSTRUMENTS	121
MOLT AUTO CLAVABLE PLASTIC TIPS	119
MONARI COMPOSITE MODELLING INSTRUMENTS	85
MORTENSON FILLING INSTRUMENTS	80,87
MOUTH MIRROR EXPLORERS	51
MOUTH MIRRORS	49
MOUTH PROPS	94
MOVEABLE HEIGHT GAUGE	125
MSY CEMENT SPATULAS	95
MUHELMANN SCALER	64,65
MULTIFUNCTIONAL METER	145
MULTI-PURPOSE PLIER	137
<b>N</b>	
NAKAWALNI DENTAL LABORATORY INSTRUMENT	97
NANCE LOOP FORMING PLIERS	132,137
NAPKIN HOLDER WITH METAL CHAIN	94
NAPKIN HOLDER WITH PLASTIC CHAIN	94
NARROW GIOVELAND RETAINERS	115
NEEDLE HOLDERS	108to109
NEEDLE STERILIZATION TUB	186
NEUMANN GUM SCISSORS	105
NEVIUS EXTRACTING FORCEPS (AMERICAN PATTERN)	14,16
NORMAL HANDLE EXPLORERS	54
NOYES GUM SCISSORS	105
<b>O</b>	
OBTUSE IMPLANTOLOGY	161
OCCUSAL ANATOMY INSTRUMENT	148
OH - PERIOSTEEL ELEVATORS	120
OLSEN-HEGAR NEEDLE HOLDER WITH SCISSORS	107
OMEGA LOOP FORMING PLIERS	141
ORBAN SCALER	64
ORTHO BAND PUSHER SCALER	131
ORTHO INSTRUMENT	130
ORTHO LIGATURE DIRECTOR SINGLE ENDED	131
ORTHO LIGHT BAND PUSHER SCALER	129
ORTHO LIGHT DOUBLE ENDED LIGATURE	131
ORTHO LIGHT DOUBLE ENDED LIGATURE DIRECTOR	131
ORTHO LIGHT DOUBLE ENDED LIGATURE DIRECTOR SCALER	129,131
ORTHO LIGHT DOUBLE ENDED LIGATURE SCALER	131
ORTHO LIGHT LIGATURE DIRECTOR DOUBLE ENDED	131
ORTHO LIGHT SCALER	130
ORTHO LIGHT SCALER DOUBLE ENDED	130
ORTHO LIGHT SCALER HEAVY	130
ORTHO LIGHT SCALER SINGLE ENDED	131
ORTHO RULER / CONE SOCKET	146
ORTHODONTIC INSTRUMENTS	128to131
ORTHODONTICS PLIERS STANDS	144
ORTHOLITE LIGATURE DIRECTOR SCALER	131
OSTEOMETER MEASURING FORCEPS FOR JAW	146
OSTEOTOME CONVEXES / CONCAVE / CONIQUES	171,172
OSTEOTOME CONVEXES / CONCAVE / CONIQUES SET OF 5 PIECES	172
<b>P</b>	
P.K. THOMS WAXING INSTRUMENTS KIT	89
P.K. THOMS WAXING INSTRUMENTS SOLID HANDLE	89
PALATAL-ADULT DENTAL PHOTOGRAPHIC MIRRORS	98
PALATAL-ADULT LARGE DENTAL PHOTOGRAPHIC MIRRORS	98
PALATAL-CHILD DENTAL PHOTOGRAPHIC MIRRORS	98
PALMER RUBBER DAM CLAMPS FORCEPS	111
PARMLY EXTRACTING FORCEPS (AMERICAN PATTERN)	16
PARTSCH PERIOSTEEL ELEVATORS	120
PDL ELEVATORS	47,48
PDL ELEVATORS SET OF 7 PCS	47
PDL ELEVATORS SET OF 7 PCS	47
PDL ELEVATORS SET OF 8 PCS	48
PEDIATRIC TOOTH EXTRACTING FORCEPS SET	08
PEET SPLINTER FORCEPS	109
PERFORATED WITH RIM LOCK SET OF 06 PCS	179
PERFORATED WITH RIM LOCK SET OF 10 PCS	179
PERFORATED WITH RIM LOCK SET OF 8 PCS	179
PERIODONTAL CHISELS	118
PERIODONTAL INSTRUMENTS	120to122
PERIODONTAL KNIVES	64
PERIODONTAL PROBES	58
PERIODONTAL PROBESSPREADERS	57
PERIODONTAL SURGERY	162
PERIOSTEEL	
ELEVATORS	120,154
PERIOTOME ROOTS ELEVATOR	43
FERRY TWEEZERS	52,53
PHYSIC EXTRACTING FORCEPS (AMERICAN PATTERN)	18
PIN & LIGATURE CUTTER	142
PIN & LIGATURE CUTTERS TC	139
PIN HOLDING PLIER TC	140
PIN-TWEEZERS	170
PLAIN MOUTH MIRRORS	49
PLANATOR	69
PLANATOR	69
PLASTER KNIFE	96
PLASTER SHEARS	124
PLASTIC FILLING INSTRUMENTS	93
PLIER STAND PLASTIC	144
PLIER STAND STAINLESS STEEL	144
PLIERS FOR ORTHODONTICS & PROSTHETICS	132to143
PLIERS STAND STAINLESS ROD (ALUMINUM ANODIZED)	144
PLUGGERS	56
PLUGGERS/CONDENSERS	87
POSITIONING 3 IMPLANTOLOGY	161



# INDEX

DESCRIPTION	PAGE#
POSITIVE POSITIONER	125
POSTERIOR BAND REMOVING PLIERS - LONG	141
POSTERIOR BAND REMOVING PLIERS - SHORT	141
POTTS "T-HANDLE" ELEVATOR-LEFT	41
POTTS "T-HANDLE" ELEVATOR-RIGHT	41
PRICHARD PERIODONTAL INSTRUMENTS	121
PROBE EXPLORERS	51
PRONG 3 CLASP ADJUSTABLE PLIER TC	140
<b>Q</b>	
QUATRO DENTAL SYRINGES	27
<b>R</b>	
RASPATOR, PRICHARD	165
RASPATOR, RASPATORY	120
RASPATOR, WILLIGER	120
RECTANGULAR ARCH BENDING PLIERS	143
RETRACTOR SELDIN	103
RETRACTORS - MOUTH GAGS	99,100
RETRACTORS	101to103
RHODIUM MOUTH MIRRORS	49
RIBBON RETRACTORS	101
RIDGE MAPPING DOUBLE CALIPER	146
RING 2 DENTAL SYRINGES	27
ROCHESTER-KÖCHER HAEMOSTATIC FORCEPS	110
ROCHESTER-PEAN HAEMOSTATIC FORCEPS	110
ROOT CANAL PLUGGER	56
ROOT ELEVATOR	29to48
ROOT ELEVATORS SET OF 10 PCS	46
ROOT FRAGMENT FORCEPS	09,11
ROOT PICK ELEVATOR WITH GOLD FLEXIBLE POINTS	42
ROOT PLANNING FILES	119
ROOT PLANNING FILES & BONE FILES	119
ROOTS SPLINTER FORCEPS	10
ROSER-KÖNIG RETRACTORS - MOUTH GAGS	100
ROUND AND CONCAVE PLIER	139
ROUND ENDOODONTIC BOXES	186
ROUND EXCAVATOR	86
ROUND TORQUE WRENCH UNIVERSAL	177
ROUTURIER EXTRACTING FORCEPS (ENGLISH PATTERN)	03
ROUTURIER EXTRACTING FORCEPS FOR LOWER MOLARS	03
RUBBER DAM CLAMPS	113
RUBBER DAM CLAMPS FORCEPS	111
RUBBER DAM CLAMPS KITS	112
RUBBER DAM FRAME	111
RUBBER DAM TEMPLATE	112
RULER	127
RULER WEDGE	127
RUSSIAN LONG TISSUE FORCEPS	170
RUSSIAN TISSUE FORCEPS	170
RYDER NEEDLE HOLDERS	106,107
<b>S</b>	
SAW BLADES	124
SCALER	59to67
SCALERS TRAYS	183
SCALPEL HANDLE STRAIGHT	123
SCALPEL HANDLES	123
SCHLEMMER ROOTS ELEVATOR	37
SCHMIDLIN PERIODONTAL INSTRUMENTS	122
SCHURE BAND SEATER	130
SCHWARTZ PLIERS	139
SEPARATING ELASTIC PLIER	111
SELDIN PERIODONTAL INSTRUMENTS	112
SELDIN ROOT ELEVATORS	29,32
SELF LOCKING GROOVED	169
SELF-LOCKING TWEEZER	53
SEMKEN TAYLOR TWEEZERS	52
SENN MUELLER RETRACTOR	102
SERRATED PLUGGERS	84
SET OF 5 PIECES	171
SHEPHERD'S HOOK EXPLORER	54
SHORT IMPLANT DRILLS	176
SICKLE SCALERS	63
SIMPLEX RETRACTOR	100
SINUS ELEVATOR & MEMBRANE LIFT TIPS	164
SINUS IMPLANTOLOGY	156,161
SINUS LEFT ELEVATOR & MEMBRANE LIFT TIPS 3 SET OF 7 PCS	164
SINUS LEFT ELEVATOR SET OF 10 PCS	158
SINUS LEFT ELEVATOR	151,157
SINUS LEFT ELEVATORS SET OF 7 PCS WITH CASSETTE	157
SINUS LIFT INSTRUMENT	150to152,161
SINUSLIFT IMPLANTOLOGY	150,161
SIQVELAND RETAINERS	115
SLIM WEINGART PLIERS	141
SLIPPER TWEEZERS	128
SMAHA ELASTOMERIC LIGATURE PLACING FORCEPS	140
SMALL/MEDIUM BALL BURNISHER	149
SOFT BRUSHING KIT SET OF 6 PCS	163
SOFT WIRE AND LIGATURE CUTTER	135
SOFT WIRE AND LIGATURE CUTTER, STANDARD	135
SPATULAS	73
SPATULAS ROUNDED AND SHARP	72
SPECIAL INOX	124
SPECIAL INOX WAX KNIVES	96
SPENCER GUM SCISSORS	105
SPIRIT LAMP	186
SPLINTER FORCEPS	10
SPOON AND PUSHER (TRINOVO)	167
STANDARD LIGATURE CUTTER TC	139
STAR TORQUE WRENCH UNIVERSAL	177
STERILIZING BOXES & INSTRUMENTS TRAYS	184
STERILIZING MESH TRAY	190
STERNBERG RETRACTORS	99
STIEGLITZ ROOT FRAGMENTS	10
STIEGLITZ SPLINTER FORCEPS	10
STOCKES RUBBER DAM CLAMPS FORCEPS	111
STOP PLIERS V-BEED	137
STRAIGHT DIRECT BOND BRACKET REMOVER TC	140
STRIP SAW	125
SUCTION CANNULA KIT WITH 3 NEEDLES	178
SUCTION NEEDLE	178
SUCTION PIPE	178
SUCTION TUBES	178
SURGICAL TWEEZERS	52

DESCRIPTION	PAGE#
SURGICAL BALL HOOK CRIMPING PLIERS, ANGLED	137
SURGICAL BALL HOOK CRIMPING PLIERS, STRAIGHT	137
SURGICAL CHISELS	162
SUTURE PLIERS SUTURE FORCEPS	169
SWEDISH TYPE DENTAL SYRINGES	27
SYNDEMOTOMES ROOTS ELEVATOR	43
<b>T</b>	
TAMPER	166
TANNER FILLING INSTRUMENTS	88
TARTAR REMOVER INSTRUMENTS SOLID HANDLE	67
TAYLOR SCALER	63
THICK EXPLORERS	54
THREE JAW PLIERS	143
TISSUE GRAFT FORCEP SERRATED TEETH	169
TISSUE MEMBRANE FORCEPS	169,170
TISSUE PUNCH	173
TISSUE PUNCH FORCEPS TO REMOVE TISSUE AFTER USING PUNCH	170
TISSUE PUNCH SET OF FIVE PIECES	173
TISSUE PUNCH STRAIGHT & CURVED	173
TISSUE PUNCH WITH PIN SET OF FOUR PIECES	173
TITANIUM LOCKING PLIER	169
TITANIUM PERIOSTEAL ELEVATOR FOR IMPLAN	122
TOFFLEMIRE-JUNIER SIQVELAND RETAINERS	115
TOFFLEMIRE-SENIOR SIQVELAND RETAINERS	115
TONIAS EXTRACTING FORCEPS (AMERICAN PATTERN)	17,22
TONIAS NEEDLE HOLDERS	169
TORQUE WRENCH & RATCHET	177
TORQUING PLIERS SET	137
TOWNER-JAQUETTE SCALER	63
TREPINE	175
TREPINE DRILL SET OF EIGHT PIECES	175
TRINOVO HANDLE	167
TRIO DENTAL SYRINGES	27
TRIPLE-ANGLED BACK ACTION EXCAVATOR	86
TWEED / ANGEL FORMING AND TORQUING PLIERS	134
TWEED / ANGEL RECTANGULAR ARCH FORMING AND TORQUING PLIERS	137
TWEED / ANGLE RECTANGULAR ARCH FORMING & TORQUING PLIERS	133
TWEED LOOP FORMING PLIERS	132,133,143
TWEEZERS	52,53
TWEEZERS EXPLORERS	51
TWEL-ON ELASTIC MODULE INSTRUMENT	130
TYPE C DENTAL SYRINGES	27
<b>U</b>	
UNIQUE RETRACTORS	102
UNIVERSAL CROWN REMOVER	114
UNIVERSAL CURETTES	63
UNIVERSAL CUT & HOLD DISTAL END CUTTER	142
UNIVERSAL DOLPHIN STYLE WIRE BENDING & CUTTING PLIERS	132
UNIVERSAL EXTRACTING FORCEPS (AMERICAN PATTERN)	22
UNIVERSAL MINI-ELEVATOR FOR FRAGMENTS	34
UNIVERSAL NEEDLE HOLDERS	106
UNIVERSITY OF MICHIGAN EXPLORERS	55
UNIVERSITY OF NORTH CAROLINA EXPLORER	55
UPPER ROOT ELEVATOR WITH HELICOIDAL TIP	31
US ARMY RETRACTORS	102
UTILITY PLIER WEINGART TC	140
<b>V</b>	
V BEND STOP	139
V BEND STOP PLIER TC	139
VERNIER GAUGE	127
VISTA TUNNELING INSTRUMENTS SET	155
<b>W</b>	
W BARRY ROOTS ELEVATOR	41
WAHL BONE FILES	119
WAKAI HEAT CARRIERS	57
WALDSAVHS WIRE BENDING AND CUTTING PLIERS	134
WANGEN HOLDER	99
WARD FILLING INSTRUMENTS	80
WATER SYRINGE	116
WAX KNIVES	96
WAY 6 ADJUSTABLE ANGLED SCALPEL HANDLE	123
WEIDER RETRACTOR	99
WEINGART PLIER	139
WEINGART PLIER MEDIUM	132,134
WEINGART PLIERS	141
WEINGART UTILITY PLIERS	136
WEINGART-MINI UTILITY PLIERS	136
WEITLANER RETRACTORS - MOUTH GAGS	100
WERDELSTAEDT SCALER	67
WESTCOTT BURNISHERS	68
WESTCOTT FILLING INSTRUMENTS	93
WESTON CEMENT SPATULAS	95
WHITE BURNISHERS	68
WIDE SIQVELAND RETAINERS	115
WILAND SCALER	65
WILKINS/TUFTS EXPLORER	54
WILLIAMS EXPLORERS	55
WILLIAMS FILLING INSTRUMENTS	81
WINTER EXTRACTING FORCEPS (AMERICAN PATTERN)	12
WINTER ROOTS ELEVATOR	41
WIRE BENDING & LOOP FORMING PLIERS	132
WIRE BENDING AND LOOP FORMING PLIERS ANGLED (BIRD BEAK)	136
WISDOM EXTRACTING FORCEPS	03
WISDOM ROOT ELEVATOR	36
WITZEL FORCEPS WITH ANATOMICAL HANDLE SET OF 3 PCS	09
WITZEL FORCEPS WITH GOLD SET OF 3 PCS	09
WITZEL FORCEPS WITH HOLE AND SCREW PATTERN SET OF 3 PCS	09
WITZEL ROOT FRAGMENT FORCEPS	09
WOODEN HANDLE WAX KNIVES	96
<b>X</b>	
X RAY FILM HANGERS	94
<b>Y</b>	
YOUNG TONGUE FORCEPS	110
YOUNG WIRE BENDING & LOOP FORMING PLIERS	132
YOUNGER GOOD SCALER	63
<b>Z</b>	
ZAHLE CEMENT SPATULAS	95



# SAR SONS

*Manufacturers & Exporters of Dental Instruments*

Mughal Pura Road, Gohadpur Sialkot Punjab, Pakistan 51310

+92-52-563715 ☎ +92-52-291747

Email: [info@sarsonss.com](mailto:info@sarsonss.com)

[www.sarsonss.com](http://www.sarsonss.com)